

HANDBOOK



PEUGEOT 5008



Welcome

Thank you for choosing a 5008, a symbol of confidence, passion and inspiration

This handbook has been designed to enable you to make the most of your 5008 in all circumstances and in complete safety. Take the time to read through it to familiarise yourself with the vehicle.

This handbook covers all of the variations of equipment available across the whole 5008 range.

Your vehicle will be fitted with just some of the equipment described in this document, depending on its trim level, version and the specification for the country in which it is sold.

The descriptions and images are given as an indication only. Automobiles PEUGEOT reserves the right to modify the technical specification, equipment and accessories without having to update this edition of the handbook.

This document is an integral part of your vehicle. Remember to pass it on to the new owner in the event of sale of the vehicle.

For any work on your vehicle, use a qualified workshop that has the technical information, competence and equipment required, which a PEUGEOT dealer is able to provide.



We draw your attention to the following points:

- The fitting of electrical equipment or accessories not listed by PEUGEOT may cause faults and failures with the electrical system of your vehicle. Contact a PEUGEOT dealer or a qualified workshop for information on the range of recommended accessories.
- Any modification or adaptation not intended or authorised by Automobiles PEUGEOT or carried out without meeting the technical requirements defined by the manufacturer would lead to the suspension of the new vehicle warranty.

Key

Warning:

this symbol is for warnings that you must observe for your own safety, the safety of others, and to avoid the risk of damage to your vehicle.

Information:

this symbol draws your attention to additional information for the best use of your vehicle.



Protection of the environment:

this symbol accompanies advice related to the protection of the environment.

Exterior

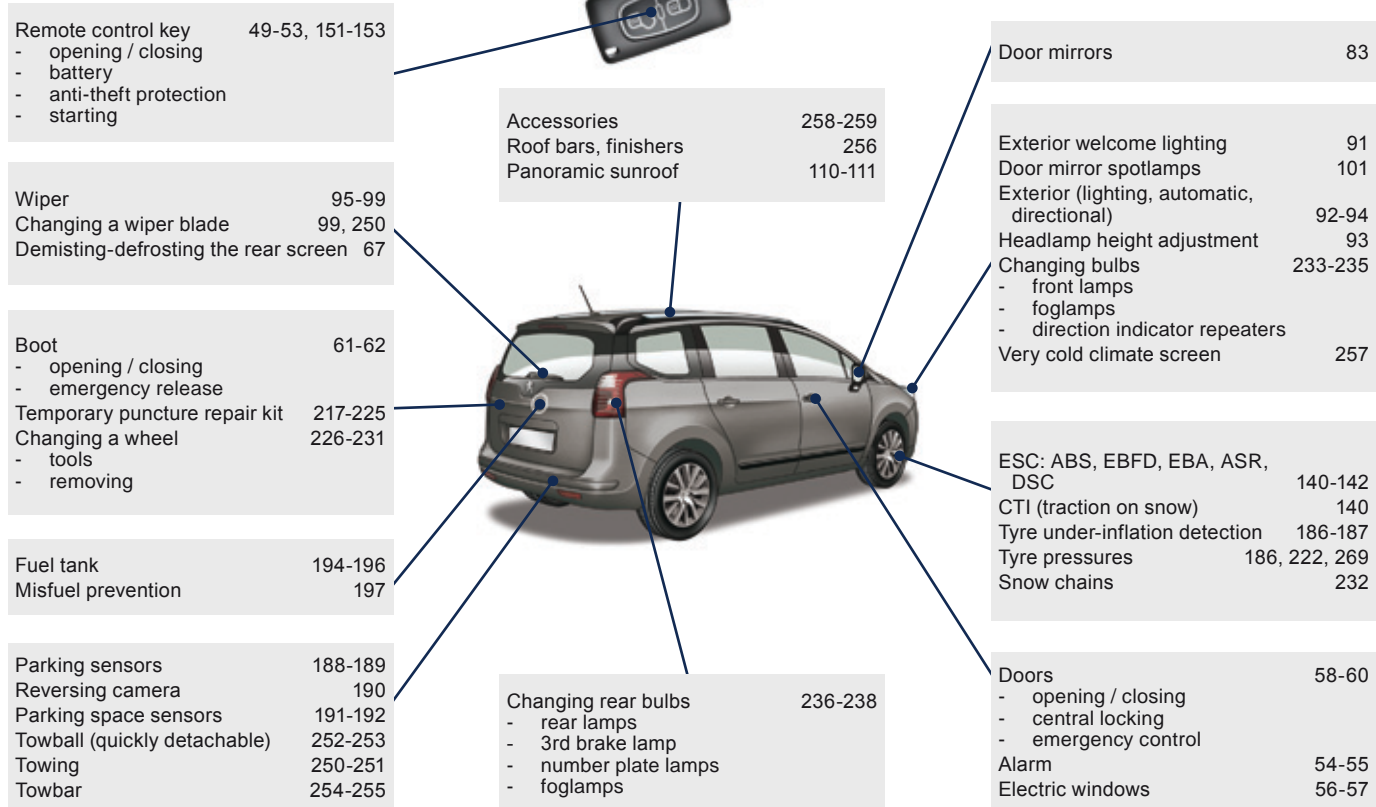

Interior

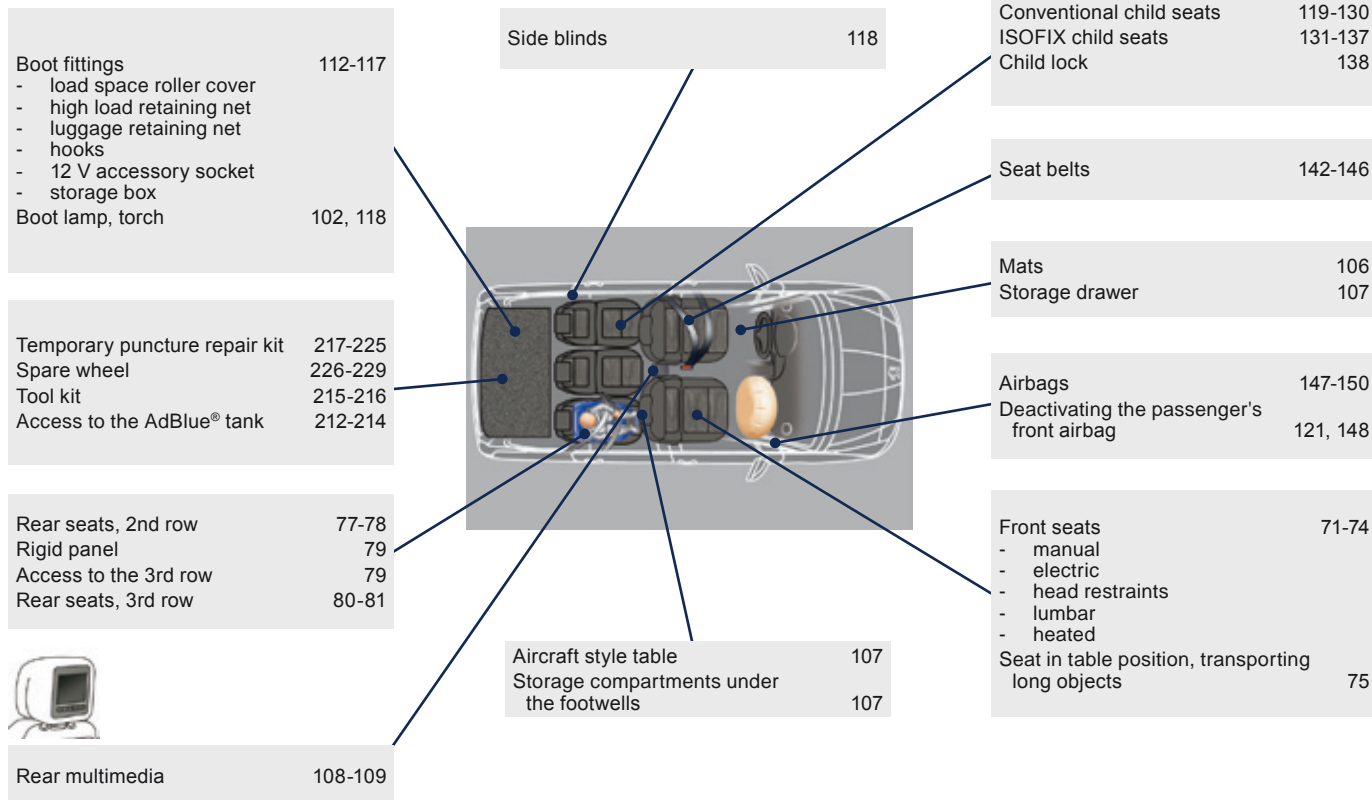

Instruments and controls

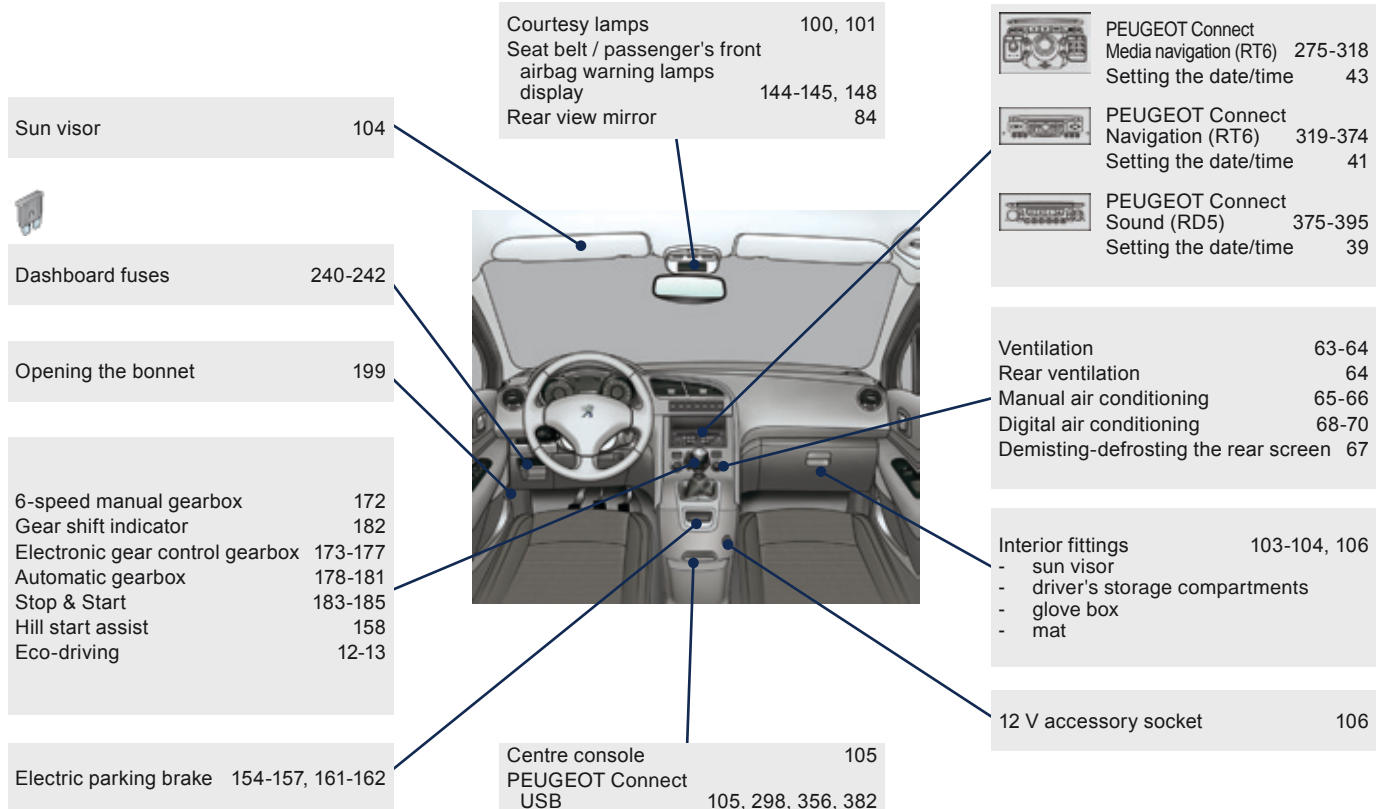

Instruments and controls

| | | | | | | | | | | | | | | | | | | | |
|---|---------|---|----------------------------|---------------------------|---|-----------------------|-------|------------|--|------------|--|----------------------|--|--------------------|----|----------------------------------|-------|------------------------------|---------|
| Head-up display | 161-162 | | Instrument panels, screens | 14-16 | <table border="0"> <tbody> <tr> <td>Multifunction screens</td> <td>33-43</td> </tr> <tr> <td>- Screen A</td> <td></td> </tr> <tr> <td>- Screen C</td> <td></td> </tr> <tr> <td>- 16/9 colour screen</td> <td></td> </tr> <tr> <td>Retractable screen</td> <td>44</td> </tr> <tr> <td>Screen A (setting the date/time)</td> <td>33-36</td> </tr> <tr> <td>Emergency or assistance call</td> <td>271-274</td> </tr> </tbody> </table> | Multifunction screens | 33-43 | - Screen A | | - Screen C | | - 16/9 colour screen | | Retractable screen | 44 | Screen A (setting the date/time) | 33-36 | Emergency or assistance call | 271-274 |
| Multifunction screens | 33-43 | | | | | | | | | | | | | | | | | | |
| - Screen A | | | | | | | | | | | | | | | | | | | |
| - Screen C | | | | | | | | | | | | | | | | | | | |
| - 16/9 colour screen | | | | | | | | | | | | | | | | | | | |
| Retractable screen | 44 | | | | | | | | | | | | | | | | | | |
| Screen A (setting the date/time) | 33-36 | | | | | | | | | | | | | | | | | | |
| Emergency or assistance call | 271-274 | | | | | | | | | | | | | | | | | | |
| Distance alert | 163-165 | | Warning lamps | 17-27 | | | | | | | | | | | | | | | |
| Lighting controls | 86-92 | | Indicators | 28-31 | | | | | | | | | | | | | | | |
| Direction indicators | 139 | Gear shift indicator | 182 | | | | | | | | | | | | | | | | |
| Speed limiter | 166-168 | Buttons | 30, 32 | | | | | | | | | | | | | | | | |
| Cruise control | 169-171 | - check / service indicator / trip distance recorder | | | | | | | | | | | | | | | | | |
| Switch panel | 8-10 | - lighting dimmer | | | | | | | | | | | | | | | | | |
| Stop & Start | 183-185 | | | | | | | | | | | | | | | | | | |
| Door mirrors | 83 | | | | | | | | | | | | | | | | | | |
| Electric windows, deactivating | 56-57 | | | | | | | | | | | | | | | | | | |
| PEUGEOT Connect Media Navigation (NG4 3D) instrument panel navigator | 15 | | | | | | | | | | | | | | | | | | |
| Adjusting headlamps | 93 | | | | | | | | | | | | | | | | | | |
| | | | | Centre switch panel | 8-10 | | | | | | | | | | | | | | |
| | | | | Hazard warning lamps | 139 | | | | | | | | | | | | | | |
| | | | | Head-up display | 161-162 | | | | | | | | | | | | | | |
| | | | | Distance alert | 163-165 | | | | | | | | | | | | | | |
| | | | | Wiper controls | 95-99 | | | | | | | | | | | | | | |
| | | | | Trip computer | 46-48 | | | | | | | | | | | | | | |
| | | | | Ignition switch | 151-153 | | | | | | | | | | | | | | |
| | | | | Panoramic sunroof | 110-111 | | | | | | | | | | | | | | |
| | | | | Steering wheel adjustment | 85 | | | | | | | | | | | | | | |
| | | | | Horn | 139 | | | | | | | | | | | | | | |

Switch panel

Version 1

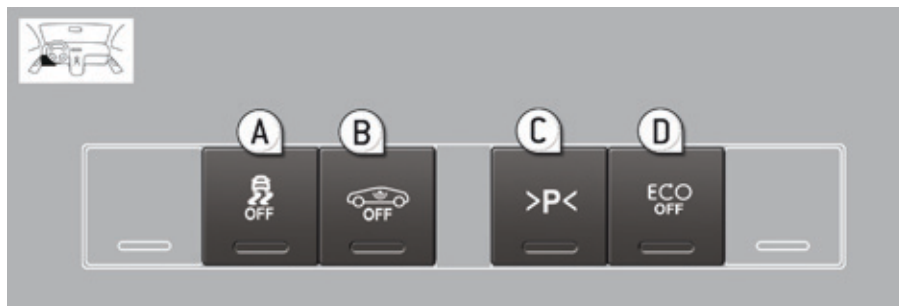

Side

The illumination of the indicator lamp shows the state of the corresponding function.

| | |
|-------------------------------|---------|
| A. ASR/DSC OFF. | 140-142 |
| B. Volumetric alarm. | 54-55 |
| C. Parking space measurement. | 191-192 |
| D. Stop & Start. | 183-185 |

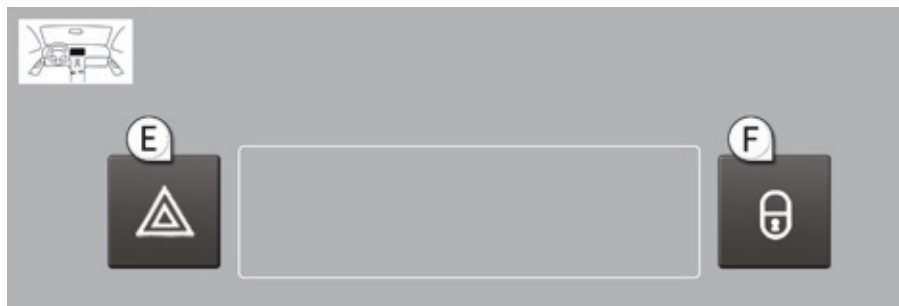

Centre

| | |
|--------------------------|-------|
| E. Hazard warning lamps. | 139 |
| F. Central locking. | 59-60 |

Version 2

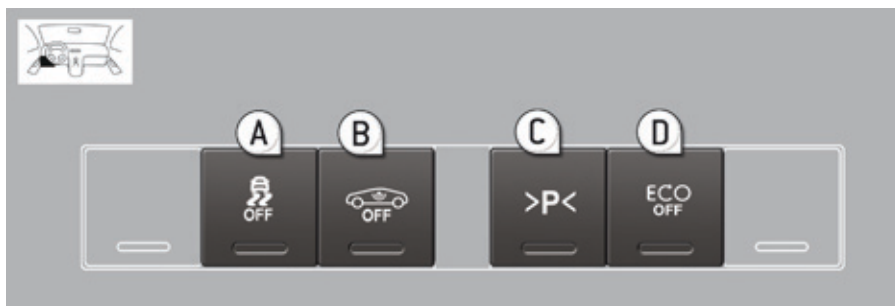

Side

The illumination of the indicator lamp shows the state of the corresponding function.

| | |
|-------------------------------|---------|
| A. ASR/DSC OFF. | 140-142 |
| B. Volumetric alarm. | 54-55 |
| C. Parking space measurement. | 191-192 |
| D. Stop & Start. | 183-185 |

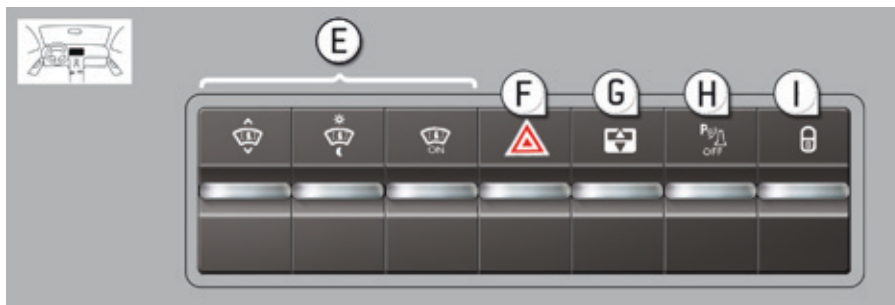

Centre

| | |
|---|---------|
| E. Head-up display. | 161-162 |
| F. Hazard warning lamps. | 139 |
| G. Blind. | 110-111 |
| H. Visual and audible parking assistance. | 188-189 |
| I. Central locking. | 59-60 |

Version 3

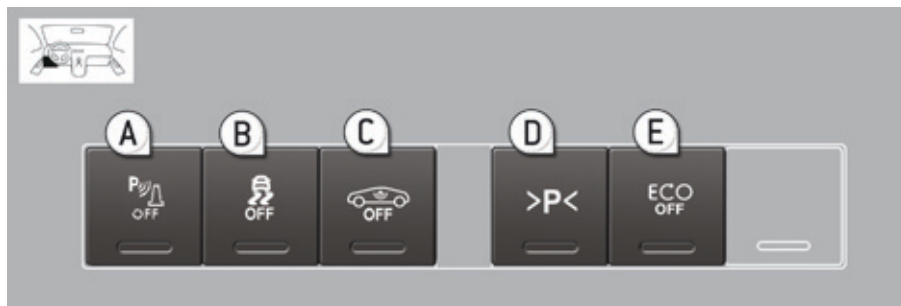

Side

The illumination of the indicator lamp shows the state of the corresponding function.

| | |
|--|---------|
| A. Visual and audible parking assistance. | 188-189 |
| B. ASR/DSC OFF. | 140-142 |
| C. Volumetric alarm. | 54-55 |
| D. parking space measurement. | 191-192 |
| E. Stop & Start. | 183-185 |

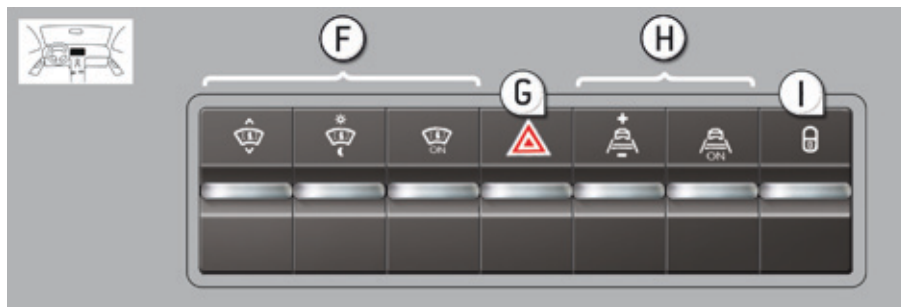

Centre

| | |
|---------------------------------|---------|
| F. Head-up display. | 161-162 |
| G. Hazard warning lamps. | 139 |
| H. Distance alert. | 163-165 |
| I. Central locking. | 59-60 |

Maintenance - Technical data

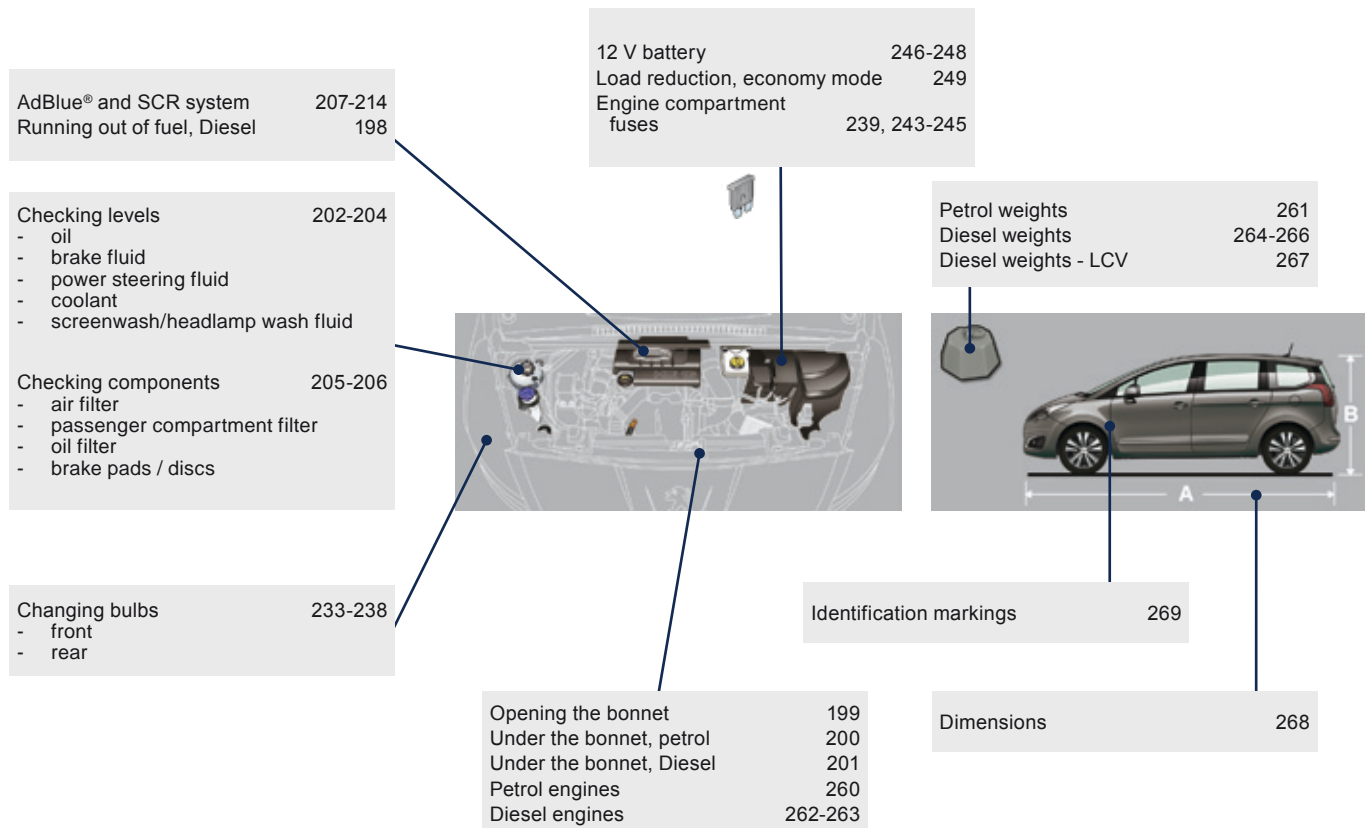

Eco-driving

Eco-driving is a range of everyday practices that allow the motorist to optimise their fuel consumption and CO₂ emissions.

Optimise the use of your gearbox

With a manual gearbox, move off gently and change up without waiting. During acceleration change up early.

With an automatic or electronic gearbox, give preference to automatic mode and avoid pressing the accelerator pedal heavily or suddenly.

The gear shift indicator invites you engage the most suitable gear: as soon as the indication is displayed in the instrument panel, follow it straight away.

For vehicles fitted with an electronic or automatic gearbox, this indicator appears only in manual mode.

Drive smoothly

Maintain a safe distance between vehicles, use engine braking rather than the brake pedal, and press the accelerator progressively. These practices contribute towards a reduction in fuel consumption and CO₂ emissions and also helps reduce the background traffic noise.

If your vehicle has cruise control, make use of the system at speeds above 25 mph (40 km/h) when the traffic is flowing well.

Control the use of your electrical equipment

Before moving off, if the passenger compartment is too warm, ventilate it by opening the windows and air vents before using the air conditioning. Above 30 mph (50 km/h), close the windows and leave the air vents open.

Remember to make use of equipment that can help keep the temperature in the passenger compartment down (sunroof and window blinds...).

Switch off the air conditioning, unless it has automatic regulation, as soon as the desired temperature is attained.

Switch off the demisting and defrosting controls, if not automatic.

Switch off the heated seat as soon as possible.

Switch off the headlamps and front foglamps when the level of light does not require their use.

Avoid running the engine before moving off, particularly in winter; your vehicle will warm up much faster while driving.

As a passenger, if you avoid connecting your multimedia devices (film, music, video game...), you will contribute towards limiting the consumption of electrical energy, and so of fuel.

Disconnect your portable devices before leaving the vehicle.

Limit the causes of excess consumption

Spread loads throughout the vehicle; place the heaviest items in the bottom of the boot, as close as possible to the rear seats.

Limit the loads carried in the vehicle and reduce wind resistance (roof bars, roof rack, bicycle carrier, trailer...). Use a roof box in preference. Remove roof bars and roof racks after use.

At the end of winter, remove snow tyres and refit your summer tyres.

Observe the recommendations on maintenance

Check the tyre pressures regularly, when cold, referring to the label in the door aperture, driver's side.

Carry out this check in particular:

- before a long journey,
- at each change of season,
- after a long period out of use.

Don't forget the spare wheel and the tyres on any trailer or caravan.

Have your vehicle serviced regularly (engine oil, oil filter, air filter, passenger compartment filter...) and observe the schedule of operations recommended in the personalised service plan for your vehicle.

With a BlueHDi Diesel engine, if the SCR system is faulty your vehicle becomes polluting; go to a PEUGEOT dealer or a qualified workshop without delay to have the emissions of nitrous oxides brought back to the legal level.

When refuelling, do not continue after the third cut-off of the nozzle to avoid any overflow.

At the wheel of your new vehicle, it is only after the first 1 800 miles (3 000 kilometres) that you will see the fuel consumption settle down to a consistent average.

Instrument panels

Panel grouping together the vehicle operation indication dials and warning lamps.



Dials

1. **Rev counter.**
Indicates the engine speed (x 1 000 rpm).
2. **Coolant temperature.**
Indicates the temperature of the engine coolant (° Celsius).
3. **Fuel level.**
Indicates the quantity of fuel remaining in the tank.
4. **Speedometer.**
Indicates the current speed of the moving vehicle (mph or km/h).
5. **Screen.**
6. **Control switch.**
Temporary display of the service indicator and driving range with the AdBlue® additive.
Display and reset the selected function (trip distance recorder or service indicator).
7. **Instrument panel lighting dimmer.**
Adjusts the brightness of the lighting of the instruments and controls, if the vehicle lighting is on.

i For more information, refer to the section corresponding to the button or function and its associated display.

Screen(s)

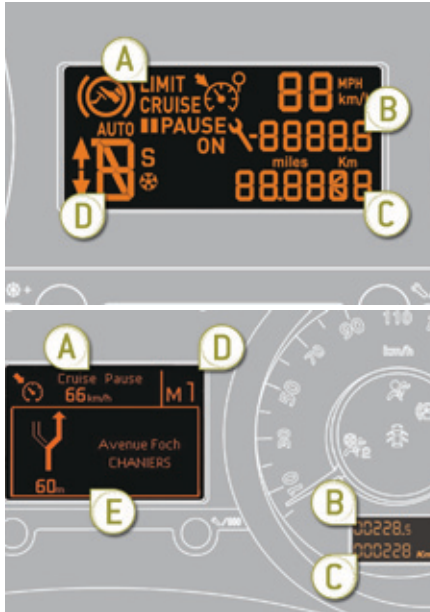

- A. Speed limiter**
or
Cruise control.
(mph or km/h)
- B. Trip distance recorder.**
(miles or km)

- C. Service indicator.**
(miles or km) or,
Engine oil level indicator (depending on version).
or
distance recorder.
(miles or km)
- D. Gear shift indicator.**
Electronic or automatic gearbox.
- E. Warning messages and function status messages, trip computer, GPS navigation information.**

Instrument panel navigator

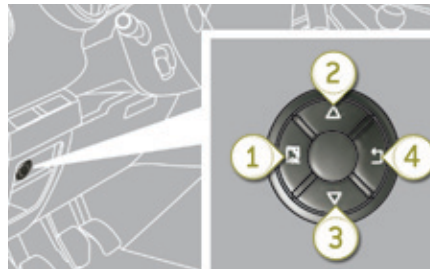

This group of buttons permits:

- **When stationary**, configuration of the vehicle's equipment and the screen settings (languages, units...),
- **While driving**, scrolling of the active functions (trip computer, navigation...).

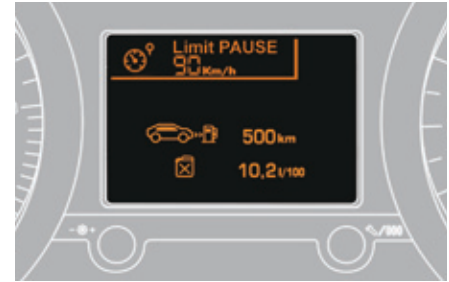

Controls

There are four buttons to control the screen in the instrument panel:

1. Access the main menu, confirm the selection.
2. Move up through the menu.
3. Move down through the menu.
4. Return to the previous display, exit from the menu.

i The main menu and its associated functions can only be accessed when stationary, via buttons **1** to **4**. A message appears in the screen, above a certain speed threshold, indicating that the main menu cannot be displayed. The trip computer displays can only be accessed while driving, via buttons **2** and **3** (refer to the "Trip computer" section).

Main menu

- ☞ Press button **1** for access to the main menu and select one of the following functions:
 - "Vehicle parameters",
 - "Choice of language",
 - "Choice of units".
- ☞ Press button **2** or **3** to move in the screen.
- ☞ Press button **1** again to confirm the selection.

Vehicle parameters

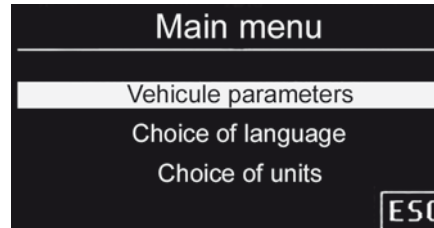

This menu allows you to activate or deactivate certain driving and comfort equipment*:

- wiper linked with reverse gear (refer to the "Visibility" section),
- selective unlocking (refer to the "Access" section),
- guide-me-home lighting (refer to the "Visibility" section),
- directional headlamps (refer to the "Visibility" section),
- automatic or manual parking brake* (refer to the "Driving" section).

Choice of language

This menu allows you to select the display language.

Choice of units

This menu allows you to select the units: temperature (°Celsius or °Fahrenheit) and fuel consumption (l/100 km, mpg or km/l).

* Depending on the country of sale.

Indicator and warning lamps

Visual indicators informing the driver that a system is in operation (operation or deactivation indicator lamps) or of the occurrence of a fault (warning lamp).

When the ignition is switched on

Certain warning lamps come on for a few seconds when the vehicle's ignition is switched on.

When the engine is started, these same warning lamps should go off.

If they remain on, before moving off, refer to the information on the warning lamp concerned.



Associated warnings







The illumination of certain warning lamps may be accompanied by an audible signal and a message in the multifunction screen.





i The warning lamps may come on continuously (fixed) or flash. Certain warning lamps may come on in one of two different modes. Only by relating the type of illumination to the operating status of the vehicle can it be ascertained whether the situation is normal or whether a fault has occurred.

Operation indicator lamps

If one of the following indicator lamps comes on, this confirms that the corresponding system has come into operation.

| Warning lamp | | is on | Cause | Action / Observations |
|---|---------------------------------------|-----------------------|--|-----------------------|
|  | Left-hand direction indicator | flashing with buzzer. | The lighting stalk is pushed down. | |
|  | Right-hand direction indicator | flashing with buzzer. | The lighting stalk is pushed up. | |
|  | Sidelamps | fixed. | The lighting stalk is in the "Sidelamps" position. | |

| Warning lamp | | is on | Cause | Action / Observations |
|---|----------------------------------|--------|--|--|
|  | Dipped beam headlamps | fixed. | The lighting stalk is in the "Dipped beam headlamps" position. | |
|  | Main beam headlamps | fixed. | The lighting stalk is pulled towards you. | Pull the stalk to return to dipped beam headlamps. |
|  | Front foglamps | fixed. | The front foglamps are switched on. | Turn the ring on the stalk rearwards twice to switch off the front foglamps. |
|  | Rear foglamps | fixed. | The rear foglamps are switched on. | Turn the ring on the stalk rearwards to switch off the rear foglamps. |
|  | Diesel engine pre-heating | fixed. | The ignition switch is at the 2nd position (ignition on). | Wait until the warning lamp has switched off before starting. The duration for which the warning lamp is on is determined by the climatic conditions. |
|  | Electric parking brake | fixed. | The electric parking brake is applied. | Release the electric parking brake to switch off the warning lamp: with your foot on the brake pedal, pull the electric parking brake control lever. Observe the safety recommendations. For more information on the electric parking brake, refer to the corresponding section. |

| Warning lamp | | is on | Cause | Action / Observations |
|---|--|---|---|--|
|  | Deactivation of the automatic functions of the electric parking brake | fixed. | The "automatic application" (on switching off the engine) and "automatic release" functions are deactivated or faulty. | Activate the function (according to country) via the vehicle configuration menu or contact a PEUGEOT dealer or a qualified workshop if automatic application / release is not possible. For more information on the electric parking brake, refer to the corresponding section. |
|  | Foot on the brake pedal | fixed. | The brake pedal is not pressed. | You must press the brake pedal firmly to: <ul style="list-style-type: none"> - start the engine with an electronic gearbox (lever in position N), - manually release the parking brake. |
| | | flashing. | With an electronic gearbox, if you hold the vehicle on an incline using the accelerator for too long, the clutch overheats. | Use the brake pedal and/or the electric parking brake. |
|  | Parking space sensors | fixed. | The parking space sensors function is active. | Press the corresponding button to deactivate it. |
| | | flashing. | The system is measuring the space. | Once the measurement has been done, the warning lamp comes on fixed again. |
|  | Stop & Start | fixed. | When the vehicle stops (red lights, traffic jams, ...) the Stop & Start system has put the engine into STOP mode. | The warning lamp goes off and the engine restarts automatically in START mode, as soon as you want to move off. |
| | | flashes for a few seconds, then goes off. | STOP mode is temporarily unavailable. or START mode is invoked automatically. | For more information on special cases with STOP mode and START mode, refer to the "Stop & Start" section. |

Deactivation indicator lamps

If one of the following indicator lamps comes on, this confirms that the corresponding system has been switched off intentionally. This is may be accompanied by an audible signal and a message on the multifunction screen.

| Warning lamp | | is on | Cause | Action / Observations |
|---|----------------------------------|--------|--|---|
|  | Passenger's airbag system | fixed. | The control, located in the glove box, is set to the OFF position. The passenger's front airbag is deactivated. You can install a "rearward facing" child seat, unless there is a fault with the operation of the airbags (Airbag warning lamp on). | Set the control to the ON position to activate the passenger's front airbag. In this case, do not fit a child seat in the rearward facing position. |







Warning lamps





When the engine is running or the vehicle is being driven, the illumination of one of the following warning lamps indicates a fault which requires action on the part of the driver.

Any fault resulting in the illumination of a warning lamp must be investigated further by reading the associated message in the multifunction screen. If you encounter any problems, do not hesitate to contact a PEUGEOT dealer or a qualified workshop.

| Warning lamp | | is on | Cause | Action / Observations |
|--------------|-------------|---|--|---|
| STOP | STOP | fixed, alone or associated with another warning lamp, accompanied by an audible signal and a message in the screen. | Illumination of this warning lamp is associated with a serious fault with the braking system, power steering, engine lubrication system or cooling system. | Stop as soon as it is safe to do so as there is a risk that the engine will cut out while driving. Park, switch off the ignition and contact a PEUGEOT dealer or a qualified workshop. |





| Warning lamp | is on | Cause | Action / Observations |
|---|--|---|--|
|  Service | on temporarily. | A minor fault has occurred for which there is no specific warning lamp. | Identify the fault by reading the message shown in the screen, such as, for example: <ul style="list-style-type: none"> - opening of the doors, boot or bonnet, - engine oil low level, - screenwash low level, - flat remote control battery, - saturation of the particle emission filter (Diesel) As soon as the traffic conditions permit, regenerate the filter by driving at a speed of at least 40 mph (60 km/h) until the service warning lamp goes off. <ul style="list-style-type: none"> - a fault with the tyre under-inflation detection system, - ... For any other faults, contact a PEUGEOT dealer or a qualified workshop. |
| | fixed. | A major fault has occurred for which there is no specific warning lamp. | Identify the fault by reading the message shown on the screen and contact a PEUGEOT dealer or a qualified workshop. |
| | fixed, associated with the flashing and then fixed display of the service indicator spanner. | The servicing interval has been exceeded. | Only on BlueHDi Diesel versions. Your vehicle must be serviced as soon as possible. |





| Warning lamp | | is on | Cause | Action / Observations |
|--|---------------------------------------|---|--|---|
|  | Electric parking brake | flashing. | The electric parking brake is not applied automatically. The application/release is faulty. | You must stop as soon as it is safe to do so. Park on flat level ground, engage a gear (or place the lever in position P for an automatic gearbox), switch off the ignition and contact a PEUGEOT dealer or a qualified workshop. |
|  | Electric parking brake fault | fixed. | The electric parking brake has a fault. | Contact a PEUGEOT dealer or a qualified workshop without delay. For more information on the electric parking brake, refer to the corresponding section. |
|  | Braking | fixed, associated with the STOP warning lamp. | The braking system fluid level has dropped significantly. | You must stop as soon as it is safe to do so. Top up with brake fluid recommended by PEUGEOT. If the problem persists, have the system checked by a PEUGEOT dealer or a qualified workshop. |
| +  | | fixed, associated with the electric parking brake malfunction warning lamp, if the parking brake is released. | The braking system has a fault. | You must stop as soon as it is safe to do so. Park, switch off the ignition and contact a PEUGEOT dealer or a qualified workshop. |
| +  | | fixed, associated with the STOP and ABS warning lamps. | The electronic brake force distribution (EBFD) system has a fault. | You must stop as soon as it is safe to do so. Have it checked by a PEUGEOT dealer or a qualified workshop. |
|  | Anti-lock Braking System (ABS) | fixed. | The anti-lock braking system has a fault. | The vehicle retains conventional braking. Drive carefully at reduced speed and contact a PEUGEOT dealer or a qualified workshop without delay. |

| Warning lamp | | is on | Cause | Action / Observations |
|---|--|--|--|--|
|  | Dynamic stability control (DSC/ASR) | flashing. | The DSC/ASR regulation is operating. | The system optimises traction and improves the directional stability of the vehicle in the event of loss of grip or trajectory. |
| | | fixed. | The DSC/ASR system has a fault. | Have it checked by a PEUGEOT dealer or a qualified workshop. |
|  | Engine autodiagnosis system | flashing. | The engine management system has a fault. | Risk of destruction of the catalytic converter. Have it checked by a PEUGEOT dealer or a qualified workshop. |
| | | fixed. | The emission control system has a fault. | The warning lamp should go off when the engine is started. If it does not go off, contact a PEUGEOT dealer or qualified workshop without delay. |
|  | Low fuel level | fixed with the needle in the red zone. | When it first comes on there remains approximately 6 litres of fuel in the tank. At this point, you begin to use the fuel reserve. | Refuel as soon as possible to avoid running out of fuel. This warning lamp will come on every time the ignition is switched on, until a sufficient addition of fuel is made. Fuel tank capacity: approximately 60 litres . Never continue to drive until you run out of fuel, as this could damage the emission control and injection systems. |
|  | Maximum coolant temperature | fixed with the needle in the red zone. | The temperature of the cooling system is too high. | Stop as soon as it is safe to do so. Wait until the engine has cooled down before topping up the level, if necessary. If the problem persists, contact a PEUGEOT dealer or a qualified workshop. |

| Warning lamp | | is on | Cause | Action / Observations |
|--------------------------|--|---|--|---|
| UREA + SERVICE | AdBlue® additive (BlueHDi Diesel) | fixed, on switching on the ignition, accompanied by an audible signal and a message indicating the remaining driving range. | The remaining driving range is between 350 miles (600 km) and 1500 miles (2400 km). | Have the AdBlue® additive tank topped up as soon as possible: go to a dealer PEUGEOT or a qualified workshop, or carry out this operation yourself by referring to the corresponding section. |
| | | flashing associated with the SERVICE warning lamp, accompanied by an audible signal and a message indicating the remaining driving range. | The remaining driving range is between 0 and 375 miles (600 km). | You must top-up the AdBlue® additive tank to avoid a breakdown : go to a dealer PEUGEOT or a qualified workshop, or carry out this operation yourself by referring to the corresponding section. |
| | | flashing, associated with the SERVICE warning lamp, accompanied by an audible signal and a message indicating that starting is prevented. | The AdBlue® tank is empty: the starting inhibition system required by legislation prevents starting of the engine. | To be able to start the engine, you must top-up the AdBlue® additive tank: go to a dealer PEUGEOT or a qualified workshop, or carry out this operation yourself by referring to the corresponding section. It is essential to add at least 3.8 litres of AdBlue® to the tank. |

| Warning lamp | is on | Cause | Action / Observations |
|---|--|---|--|
|  <p>SCR emissions control system (BlueHDi Diesel)</p> | <p>fixed, on switching on the ignition, associated with the SERVICE and engine diagnostic warning lamps, accompanied by an audible signal and a message indicating an emissions control fault.</p> | <p>A fault with the SCR emissions control system has been detected.</p> | <p>This alert disappears once the exhaust emissions return to normal levels.</p> |
| | <p>flashing, on switching on the ignition, associated with the SERVICE and engine diagnostic warning lamps, accompanied by an audible signal and a message indicating the remaining driving range.</p> | <p>The remaining driving range is between 0 and 650 miles (1 100 km).</p> | <p>Contact a PEUGEOT dealer or a qualified workshop without delay, to avoid a breakdown.</p> |
| | <p>flashing, on switching on the ignition, associated with the SERVICE and engine diagnostic warning lamps, accompanied by an audible signal and a message indicating that starting is prevented.</p> | <p>You have exceeded the authorised driving limit : the starting inhibition system prevents starting of the engine.</p> | <p>To be able to start the engine, you must call on a PEUGEOT dealer or a qualified workshop.</p> |

| Warning lamp | | is on | Cause | Action / Observations |
|---|--|---|---|--|
|  | Engine oil pressure | fixed. | There is a fault with the engine lubrication system. | You must stop as soon it is safe to do so. Park, switch off the ignition and contact a PEUGEOT dealer or a qualified workshop. |
|  | Battery charge | fixed. | The battery charging circuit has a fault (dirty or loose terminals, slack or cut alternator belt, ...). | The warning lamp should go off when the engine is started. If it does not go off, contact a PEUGEOT dealer or a qualified workshop. |
|  | Door(s) open | fixed if the speed is below 6 mph (10 km/h). | A door, the boot, the lower tailgate or the bonnet (with alarm only) is still open. | Close the door or boot. |
| | | fixed and accompanied by an audible signal if the speed is above 6 mph (10 km/h). | | |
|  | Front seat belt not fastened / unfastened | fixed then flashing accompanied by an increasing audible signal. | The driver and/or the front passenger has not fastened or has unfastened their seat belt. | Pull the strap then insert the tongue in the buckle. |
| | Rear seat belt not fastened / unfastened | fixed then flashing accompanied by an audible signal. | One or more rear passengers have unfastened their seat belt. | |

| Warning lamp | | is on | Cause | Action / Observations |
|---|------------------------------|---|--|--|
|  | Airbags | on temporarily. | This lamp comes on for a few seconds when you turn on the ignition, then goes off. | This lamp should go off when the engine is started. If it does not go off, contact a PEUGEOT dealer or a qualified workshop. |
| | | fixed. | One of the airbag or seat belt pretensioner systems has a fault. | Have it checked by a PEUGEOT dealer or a qualified workshop. |
|  | Water in Diesel | fixed. | The Diesel fuel filter contains water. | Risk of damage to the injection system on Diesel engines. Contact a PEUGEOT dealer or a qualified workshop without delay. |
|  | Directional headlamps | flashing. | The directional headlamps system has a fault. | Have it checked by a PEUGEOT dealer or a qualified workshop. |
|  +  | Under-inflation | fixed. | The pressure in one or more wheels is too low. | Check the pressure of the tyres as soon as possible. This check should preferably be carried out when the tyres are cold. |
| | | flashing then fixed, accompanied by the Service warning lamp. | The tyre pressure monitoring system has a fault or no sensor is detected on one of the wheels. | Under-inflation detection is not assured. Have the system checked by a PEUGEOT dealer or a qualified workshop. |

Coolant temperature indicator

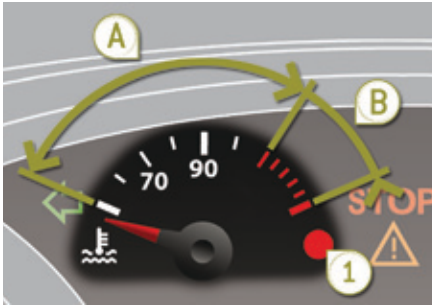

With the engine running, when the needle is:

- in zone **A**, the temperature is correct,
- in zone **B**, the temperature is too high; the max temperature warning lamp **1** and the central **STOP** warning lamp come on, accompanied by an audible signal and a message in the screen.

You must stop as soon as it is safe to do so.

Wait a few minutes before switching off the engine.

Contact a PEUGEOT dealer or a qualified workshop.

After driving for a few minutes, the temperature and pressure in the cooling system increase.

To top up the level:

- ☞ wait for the engine to cool,
- ☞ unscrew the cap by two turns to allow the pressure to drop,
- ☞ when the pressure has dropped, remove the cap,
- ☞ top up the level to the "MAX" mark.

Service indicator



System which informs the driver when the next service is due, in accordance with the manufacturer's servicing schedule. The point at which the service is due is calculated from the last indicator zero reset, according to the mileage covered since the last service.

For BlueHDi Diesel versions, depending on the country of sale, the level of deterioration of the engine oil may also be taken into account.

More than 1 800 miles (3 000 km) remain before the next service is due

When the ignition is switched on, no service information appears in the screen.

Between 600 miles (1 000 km) and 1 800 miles (3 000 km) remain before the next service is due

For 5 seconds after the ignition is switched on, the spanner symbolising the service operations comes on. The distance recorder display line indicates the distance remaining before the next service is due.

Example: 1 700 miles (2 800 km) remain before the next service is due.

For 5 seconds after the ignition is switched on, the screen indicates:



5 seconds after the ignition is switched on, **the spanner goes off**; the distance recorder resumes its normal operation. The screen then indicates the total and trip distances.

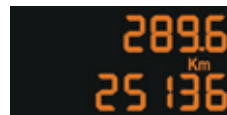

Less than 600 miles (1 000 km) remain before the next service is due

Example: 560 miles (900 km) remain before the next service is due.

For 5 seconds after the ignition is switched on, the screen indicates:



5 seconds after the ignition is switched on, the distance recorder resumes its normal operation. **The spanner remains on** to indicate that a service must be carried out soon.

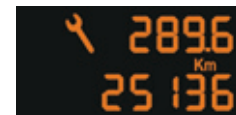

Service overdue

For 5 seconds after the ignition is switched on, **the spanner flashes** to indicate that the service must be carried out as soon as possible.

Example: the service is overdue by 186 miles (300 km).

For 5 seconds after the ignition is switched on, the screen indicates:



5 seconds after the ignition is switched on, the distance recorder resumes its normal operation. **The spanner remains on.**

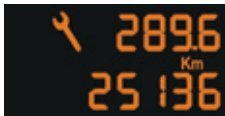

i With BlueHDi Diesel versions, the **Service** warning lamp also comes on when the ignition is switched on.

i For BlueHDi versions, the spanner may also come on early, according to the level of deterioration of the engine oil, which depends on the driving conditions in which the vehicle is used.

Service indicator zero reset



After each service, the service indicator must be reset to zero.

The procedure for resetting to zero is as follows:

- ☞ switch off the ignition,
- ☞ press and hold the trip distance recorder zero reset button,
- ☞ switch on the ignition; the distance recorder display begins a countdown,
- ☞ when the display indicates "**=0**", release the button; the spanner disappears.

i Following this operation, if you wish to disconnect the battery, lock the vehicle and wait at least five minutes for the zero reset to be taken into account.

Retrieving the service information

You can access the service information at any time.

- ☞ Press the trip distance recorder zero reset button.

The service information is displayed for a few seconds, then disappears.

Engine oil level indicator*

On versions fitted with an electric oil level indicator, the state of the engine oil level is displayed in the instrument panel for a few seconds when the ignition is switched on, after the service information.



i The level shown will only be correct if the vehicle is on level ground and the engine has been off for more than 30 minutes.

Oil level correct



Oil level low



This is signalled by the flashing of "**OIL**", or the display of a message "Oil level incorrect" in the instrument panel, accompanied by illumination of the service warning lamp and an audible signal.

If the low oil level is confirmed by a check using the dipstick, the level must be topped up to prevent damage to the engine. Refer to the "Checks of levels" section.

Oil level indicator fault



This is signalled by the flashing of "**OIL--**" or the display of a message "Oil level measurement invalid" in the instrument panel. Contact a PEUGEOT dealer or a qualified workshop.

In the event of a fault with the electric indicator, the engine oil level is no longer monitored. When the system has a fault, you should check the engine oil level using the manual dipstick (located under the bonnet).

i Refer to the "Checks of levels" section.

* Depending on version.

Distance recorders

The total and trip distances are displayed for thirty seconds when the ignition is switched off, when the driver's door is opened and when the vehicle is locked or unlocked.

i When traveling abroad, you may have to change the units of distance: the display of road speed must be in the official units (miles or km) for the country. The change of units is done via the screen configuration menu, with the vehicle stationary.

Total distance recorder

It measures the total distance travelled by the vehicle since its first registration.



Trip distance recorder

It measures a distance travelled since it was reset to zero by the driver.



e With the ignition on, press the button until zeros appear.

Lighting dimmer

System for manual adjustment of the brightness of the instrument panel in relation to the exterior brightness.



Activation

When the vehicle lighting is on:

e press the button to change the brightness of the instrument panel,
e when the lighting reaches the minimum setting, release the button, then press again to increase it,

or

e when the lighting reaches the maximum setting, release the button, then press again to reduce it,
e when the lighting reaches the level of brightness required, release the button.

i When the vehicle lighting is on, you cannot switch the instrument panel lighting off but you can adjust it to minimum.

Deactivation

When the lighting is off, or in day mode on vehicles fitted with daytime running lamps, pressing the button does not have any effect.

Monochrome screen A (without audio equipment)

Displays in the screen



This displays the following information:

- time,
- date,
- ambient temperature* (this flashes if there is a risk of ice),
- alert messages,
- trip computer (refer to the end of the section).

Warning messages (e.g.: "Emission control system faulty") or information messages (e.g.: "Boot open") may appear temporarily. Some can be cleared by pressing the **"ESC"** button.

Controls



There are three display control buttons:

- **"ESC"** to abandon the operation in progress,
- **"MENU"** to scroll through the menus or sub-menus,
- **"OK"** to select the menu or sub-menu required.

Main menu



- ☞ Press the **"MENU"** button to scroll through the various menus of the **main menu**:
 - vehicle configuration,
 - options,
 - display settings,
 - languages,
 - units.
- ☞ Press the **"OK"** button to select the menu required.

* With air conditioning only.

Vehicle configuration



Once the "Vehicle configuration" menu has been selected, you can activate or deactivate the following equipment (according to country):

- wiper linked with reverse gear (refer to the "Visibility" section),
- selective unlocking (refer to the "Access" section),
- "guide-me-home" lighting (refer to the "Visibility" section),
- directional headlamps (refer to the "Visibility" section),
- automatic parking brake** (refer to the "Driving" section),
- parking space sensors (see the "Driving" section),
- ...

Options

Once the "Options" menu has been selected, you can start diagnostics of the status of the equipment (active, not active, faulty).

Date and time

Once the "Display settings" menu has been selected, you can gain access to the following settings:

- year,
- month,
- day,
- hour,
- minutes,
- 12 or 24 hour mode.

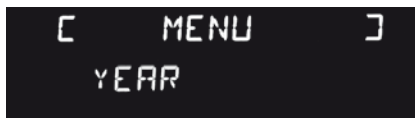

☞ Once you have selected a setting, press the "OK" button to change its value.



☞ Wait for approximately ten seconds without any action to allow the changed data to be recorded or press the "ESC" button to cancel.

The screen then returns to the normal display.

Languages

Once the "Languages" menu has been selected, you can change the language used by the display (Français, Italiano, Nederlands, Portugues, Portugues-Brasil, Türkçe, Deutsch, English, Espanol).

Units

Once the "Units" menu has been selected, you can change the units for:

- temperature (°C or °F),
- fuel consumption (l/100 km, mpg or km/l).

! For safety reasons, configuration of the multifunction screen by the driver must only be done when stationary.

** Depending on country of sale.

Monochrome screen A (with audio equipment)

Displays in the screen



This displays the following information:

- time,
- date,
- ambient temperature* (this flashes if there is a risk of ice),
- alert messages,
- audio sources (radio, CD, ...),
- trip computer (refer to the corresponding section).

Warning messages (e.g.: "Emission control system faulty") or information messages (e.g.: "Boot open") may appear temporarily. Some can be cleared by pressing the "**↩** arrow" button.

* With air conditioning only.

Controls



From the audio equipment control panel, you can:

- ☞ press the "**MENU**" button to gain access to the **main menu**,
- ☞ press the "**▲**" or "**▼**" buttons to scroll through the items on the screen,
- ☞ press the "**MODE**" button to change the permanent application (trip computer, audio source, ...),
- ☞ press the "**◀**" or "**▶**" buttons to change a setting value,
- ☞ press the "**OK**" button to confirm, or



- ☞ press this button to abandon the operation in progress.

Main menu



- ☞ Press the "**MENU**" button for access to the **main menu**, then press the "**▲**" or "**▼**" buttons to scroll through the various menus:
 - radio-CD,
 - vehicle configuration,
 - options,
 - display settings,
 - languages,
 - units.
- ☞ Press the "**OK**" button to select the menu required.

Radio-CD

With the audio equipment switched on, once the "Radio-CD" menu has been selected you can activate or deactivate the functions linked with use of the radio (RDS, REG), the CD or the CD changer (introscan, shuffle, CD repeat).



For more information on the "Radio-CD" application, refer to the "Audio equipment and telematics" section.

Vehicle configuration



Once the "Vehicle Configuration" menu has been selected, you can activate or deactivate the following equipment (according to country):

- wiper linked with reverse gear (refer to the "Visibility" section),
- selective unlocking (refer to the "Access" section),
- guide-me-home lighting (refer to the "Visibility" section),
- directional headlamps (refer to the "Visibility" section),
- automatic parking brake** (refer to the "Driving" section),
- ...

Options

Once the "Options" menu has been selected, you can start diagnostics of the status of the equipment (active, not active, faulty).

Date and time

Once the "DATE AND TIME" menu has been selected, you can gain access to the following settings:

- year,
- month,
- day,
- hour,
- minutes,
- 12 or 24 hour mode.

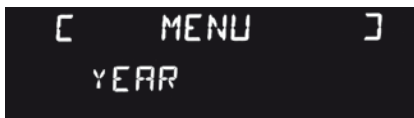

- ☞ Once you have selected a setting, press the "◀" or "▶" buttons to change its value.



- ☞ Press the "▲" or "▼" buttons to switch respectively to the previous or next setting.
- ☞ Press the "OK" button to record the change and return to the normal display or press the "↵ arrow" button to cancel.

Languages

Once the "Languages" menu has been selected, you can change the language used by the display.

Units

Once the "Units" menu has been selected, you can change the units of the following parameters:

- temperature (°C or °F),
- fuel consumption (l/100 km, mpg or km/l).

! For safety reasons, configuration of the multifunction screen by the driver must only be done when stationary.

** Depending on the country of sale.

Monochrome screen C (with PEUGEOT Connect Sound (RD5))

Displays in the screen

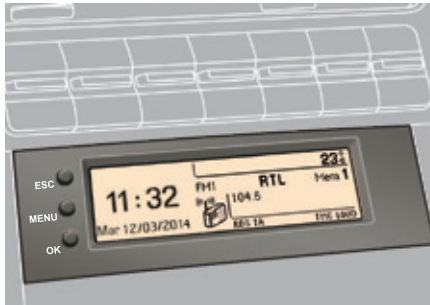

Displays according to context:

- time,
- date,
- ambient temperature with air conditioning (the value displayed flashes if there is a risk of ice),
- audio functions,
- trip computer (see the corresponding section),
- alert messages,
- screen and vehicle equipment parameter setting menus.

Controls

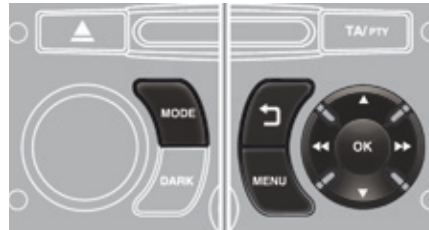

From the audio equipment control panel, you can:

- ☞ press the "**MENU**" button for access to the **main menu**,
- ☞ press the "▲" or "▼" buttons to scroll through the items on the screen,
- ☞ press the "**MODE**" button to change the permanent application (trip computer, audio source...),
- ☞ press the "◀" or "▶" buttons to change a setting value,
- ☞ press the "**OK**" button to confirm, or



- ☞ press this button to abandon the operation in progress.

Main menu



- ☞ Press the "**MENU**" button for access to the **main menu**:
 - audio functions,
 - trip computer (see the corresponding section),
 - personalisation-configuration,
 - telephone (Bluetooth system).
- ☞ Press the "▲" or "▼" button to select the menu required, then confirm by pressing the "**OK**" button.



"Audio functions" menu

With the audio equipment switched on, once this menu has been selected you can activate or deactivate the functions linked with use of the radio (RDS, REG, RadioText) or CD (introscan, shuffle, CD repeat).

i For more information on the "Audio functions" application, refer to the PEUGEOT Connect Sound (RD5) section.



"Trip computer" menu

Once this menu has been selected, you can consult information concerning the status of the vehicle (alert log, status of the functions...).

- ☞ Press the **"MENU"** button to gain access to the general menu.
- ☞ Press the arrows, then the **"OK"** button to select the **"Trip computer"** menu.



- ☞ On the **"Trip computer"** menu, select one of the applications:

Enter the distance to the destination



This allows you to enter an approximate value for the distance to the final destination.

Alert log

This summarises the active warning messages, displaying them in succession in the multifunction screen

Status of functions

This summarises the status of the functions present on the vehicle.



"Personalisation-Configuration" menu



Once this menu has been selected, you can gain access to the following functions:

- define the vehicle parameters,
- display configuration,
- choice of language.

Define the vehicle parameters

Once this menu has been selected, you can activate or deactivate the following equipment (according to country):

- wiper linked with reverse gear (see "Visibility" section),
- selective unlocking (see the "Access" section),
- guide-me-home lighting (see the "Visibility" section),
- directional headlamps (see the "Visibility" section),
- automatic parking brake* (see the "Driving" section),
- ...

* Depending on the country of sale.

Example: setting of the duration of the guide-me-home lighting

- ☞ Press the "▲" or "▼" buttons, then the "OK" button to select the menu required.

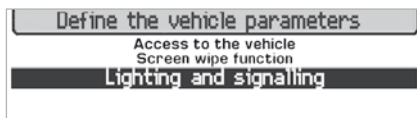

- ☞ Press the "▲" or "▼" buttons, then the "OK" button to select the "Guide-me-home headlamps" line.

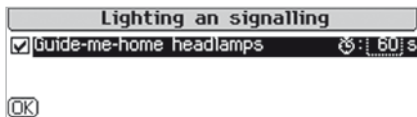

- ☞ Press the "◀" or "▶" buttons to set the value required (15, 30 or 60 seconds), then press the "OK" button to confirm.

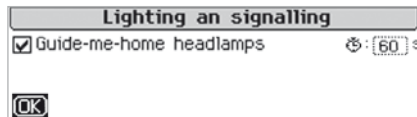

- ☞ Press the "▲" or "▼" buttons, then the "OK" button to select the "OK" box and confirm or press the "↵" arrow" button to cancel.

Display configuration

Once this menu has been selected, you have access to the following settings:

- brightness-video setting,
- date and time setting,
- selection of the units.

Adjusting the date and time

- ☞ Press the "◀" or "▶" button to select the "Display configuration" menu, then the "OK" button.
- ☞ Press the "▲" or "▼" button, to select the "Adjust date and time" line, then on the "OK" button.
- ☞ Press the "◀" or "▶" button to select the setting to modify. Confirm by pressing the "OK" button then adjust the setting and confirm again to save the modification.

- ☞ Adjust the settings one by one, confirming with the "OK" button.
- ☞ Press the "▲" or "▼" button, then the "OK" button to select the "OK" box and confirm, or the "Back" button to cancel.

Choice of language

Once this menu has been selected, you can change the screen display language.



"Telephone" menu

With the audio equipment switched on, once this menu has been selected you can configure your Bluetooth hands-free kit (pairing), consult the various telephone directories (calls log, services...) and manage your communications (pick up, hang up, call waiting, secret mode...).

i For more information on the telephone application, refer to the PEUGEOT Connect Sound (RD5) section.

! For safety reasons, configuration of the multifunction screen by the driver must only be done when stationary.

16/9 retractable colour screen (PEUGEOT Connect Navigation (RT6))

Displays in the screen



Depending on the context, it displays the following information:

- time,
- date,
- altitude,
- ambient temperature (the value displayed flashes if there is a risk of ice),
- parking sensor information,
- parking space measurement,
- audio functions,
- directory and telephone information,
- satellite navigation system information,
- trip computer,
- alert messages,
- settings menus for the screen, the satellite navigation system and vehicle systems.
- the image from the reversing camera.

Controls

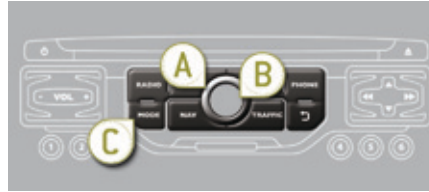

From the navigation system control panel, to select one of the applications:

- ☞ press the dedicated **"RADIO"**, **"MUSIC"**, **"NAV"**, **"TRAFFIC"**, **"PHONE"** or **"SETUP"** button for access to the corresponding menu,
- ☞ turn the dial **A** to select a function, an item in a list,
- ☞ press button **B** to confirm the selection, or
- ☞ press the **"Back"** button to abandon the current operation and return to the previous display.

With repeated presses on the **C "MODE"** button, the screen displays:

- "RADIO / MEDIA"*,
- "TELEPHONE"*,
- "FULL SCREEN MAP"*,
- "MAP IN A WINDOW"*,
- "TRIP COMPUTER".

"SETUP" menu

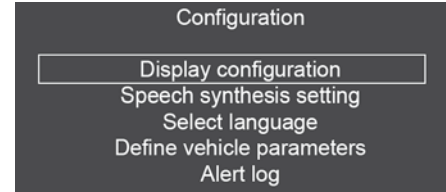

- ☞ Press the **"SETUP"** button to open the configuration menu:
 - "Display configuration",
 - "Speech synthesis setting".
 - "Select language",
 - "Define vehicle parameters",
 - "Alert log".

i For the operation of the retractable screen (opening, closing, adjusting the position...), refer to the "Access to the retractable screen" section.

! For safety reasons, configuration of the multifunction screen by the driver must only be done when stationary.

* For more information on these applications, refer to the "Audio equipment and telematics" section.

Display configuration

This menu is used to select the colour scheme for the screen, adjust the brightness, set the date and time and to choose the units for distance (km or miles), fuel consumption (l/100 km, mpg or km/l) and temperature (°Celsius or °Fahrenheit).

Adjusting the date and time

- Press on **SETUP**.
- Select "Display configuration" and confirm.
- Select "Set date and time" and confirm.

Select "Minute adjustment via GPS" so that the minutes are adjusted automatically by satellite reception.

- Select the setting to modify. Confirm by pressing on **OK**, then modify the setting and confirm again to save the modification.
- Adjust the settings one by one.
- Select **OK** in the screen then confirm to save the setting.

Adjusting the voice synthesiser

This menu is used to adjust the volume setting for navigation instructions and to choose the type of voice (male or female).

Choice of language

This menu is used to choose the language used by the screen from a defined list.

Vehicle parameters

This menu is used to activate or deactivate certain driving and comfort systems, classified by category:

- "Driver aid":
 - "Electric brake*" (Automatic electric parking brake; see "Driving" section),
- "Wiper operation":
 - **"Rear wiper operates in reverse: ON / OFF"** (rear wiper coupled to reverse gear; see the "Visibility" section),

- "Vehicle access" (see "Access" section):
 - **"Plip action: all doors, driver only"** (Selective unlocking of the driver's door),
- **"Lighting configuration"** (see "Visibility" section):
 - **"Duration of guide me home lighting: OFF / 15 s / 30 s / 60 s"** (Automatic guide me home lighting),
 - **"Directional headlights: ON / OFF"** (Main / additional directional lighting).

Alert log

This lists the active alerts by displaying in turn the different messages associated with them.

* Depending on country.

16/9 retractable colour screen (PEUGEOT Connect Media Navigation (NG4 3D))

Displays in the screen



According to context, it displays the following information:

- time,
- date,
- altitude,
- ambient temperature (the value displayed flashes if there is a risk of ice),
- audio functions,
- satellite navigation system information.
- visual parking assistance,
- the result of the measurement of free space,
- contacts and telephone information,
- configuration menus for the screen and the navigation system,

Controls

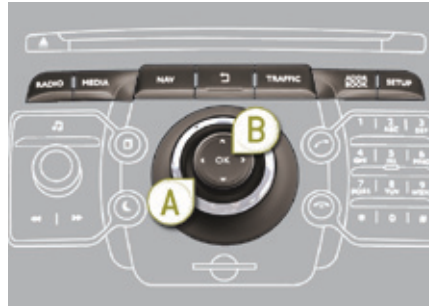

From the navigation system control panel:

- ☞ press the dedicated "**RADIO**", "**MUSIC**", "**NAV**", "**TRAFFIC**", "**SETUP**" or "**PHONE**" button for access to the corresponding menu,
- ☞ turn the navigator knob **A** to move the selection,
- ☞ press the "**OK**" navigator central button **B** to confirm the selection,

or



- ☞ press the this button to abandon the current operation and return to the previous display.

i For more information on these applications, refer to the "Audio equipment and telematics" section.

i For operation of the retractable screen (opening, closing, adjustment of the position, etc.), refer to the paragraph "Access to the retractable screen".

"SETUP" menu

- ☞ Press the **"SETUP"** button for access to the **"SETUP"** menu. It allows you to adjust settings for the following functions:
 - "Languages and voice functions"
 - "Date and time",
 - "Display screen",
 - "Units",
 - "System parameters".

Languages and voice functions

This menu allows you to:

- select the language used by the display,
- select the settings for voice recognition (on/off, instructions on use, personal voice training...),
- adjust the volume of the voice synthesiser.

Date and time

- ☞ Press **"SETUP"**.
- ☞ Select "Display configuration" and confirm.
- ☞ Select "Adjust date and time" and confirm.

Select "Synchronise minutes with GPS" for the adjustment of minutes to be done automatically by satellite reception.

- ☞ Select the setting to modify. Confirm by pressing "OK", then adjust the setting and confirm again.
- ☞ Adjust the settings one by one.
- ☞ Select "OK" in the screen then confirm to save the settings.

Display

This menu allows you to set the brightness of the screen, the screen colour scheme and the colour of the map (day/night or auto mode).

Units

This menu allows you to select the units: temperature (°C or °F) and fuel consumption (km/l, l/100 or mpg).

System parameters

This menu allows you to restore the factory configuration, display the software version and activate scrolling text.

! For safety reasons, configuration of the multifunction screen by the driver must only be done when stationary.

Access to the retractable screen

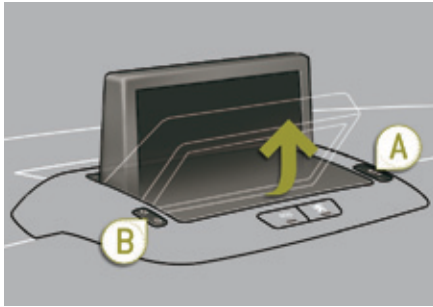

The screen opens automatically when the ignition is switched on. It closes automatically three seconds after switching off the ignition if the audio and telematics system is switched off.

You can open or close the screen at any time, with the ignition on, using control **A**.

- Press button **A**: the screen folds.
- Press button **A** again: the screen opens again.

- i** If you have closed the screen, it will open again automatically:
- on switching on the audio and navigation system (unless it had been closed manually while the system was in operation),
 - when an outgoing telephone call is made,
 - when a voice command is given,
 - when a warning message linked with the STOP warning lamp is displayed (PEUGEOT Connect Navigation (RT6)).

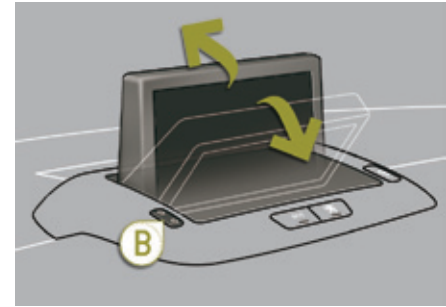

Adjusting the angle of the screen

You can adjust the angle of the screen to one of four defined positions, by repeated presses on the front or back of the control **B**. The position of the screen is memorised on closing.

Trip computer

System that gives you information on the current journey (range, fuel consumption...).

Monochrome screen A



Information displays

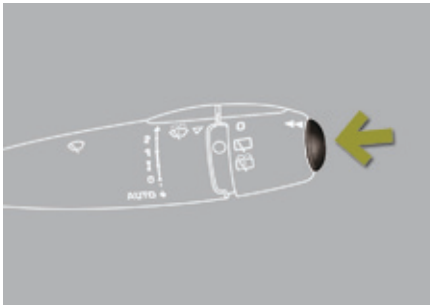

- ☞ Press the button, located at the end of the **wiper stalk**, to display the various items of trip computer data in succession.

The trip computer provides the following information:

- range,



- current fuel consumption,



- distance travelled,



- average fuel consumption,



- average speed.



- ☞ The next press returns you to the normal display.

Zero reset

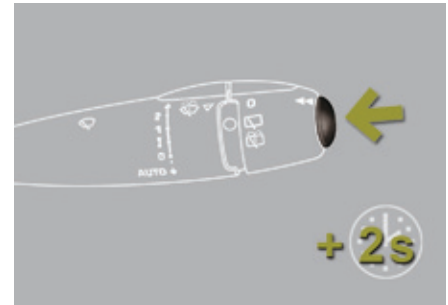

- ☞ Press the control for more than two seconds to reset to zero the distance travelled, the average fuel consumption and the average speed.

Trip computer

System which provides current information concerning the trip (range, consumption...).

Monochrome screen C



16/9 colour screen



Instrument panel screen



Information displays

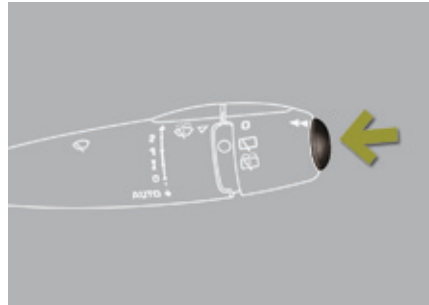

In the screen C or the colour screen

- Press the button, located at the end of the **wiper stalk**, to display the various trip computer tabs in succession.

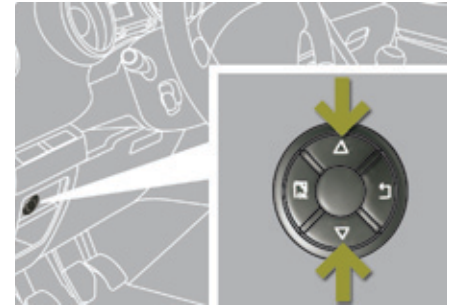

Depending on your vehicle's equipment, the trip computer information appears on the multifunction screen or on the instrument panel screen.

In the instrument panel screen

- Press the up and down arrows on the navigator to display the various trip computer tabs in succession.



- The current information tab with:
 - the range,
 - the current fuel consumption,
 - the distance remaining to be travelled.



- The trip "1" tab with:
 - the distance travelled,
 - the average fuel consumption,
 - the average speed, for the first trip.



- The trip "2" tab with:
 - the distance travelled,
 - the average fuel consumption,
 - the average speed, for the second trip.

- ☞ Pressing the button again takes you to a black screen.
A further press returns you to the normal display.

Trip zero reset

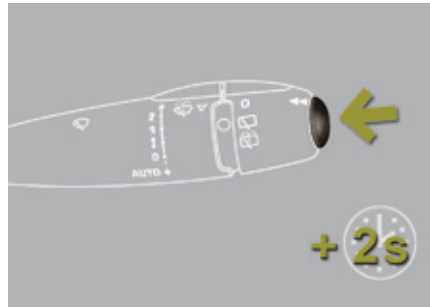

With the screen C or the colour screen

- ☞ When the trip required is displayed, press the control for more than two seconds.

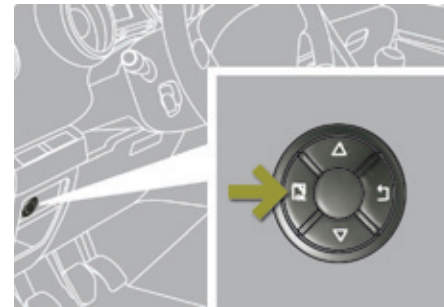

With the instrument panel screen

- ☞ When the required trip is displayed, press the "OK" button on the navigator for more than two seconds.
- Trips "1" and "2" are independent but their use is identical.
For example, trip "1" can be used for daily figures, and trip "2" for monthly figures.

Trip computer, a few definitions



Range

(miles or km)

The distance which can still be travelled with the fuel remaining in the tank (related to the average fuel consumption over the last few miles (kilometres) travelled).

i This value may vary following a change in the style of driving or the relief, resulting in a significant change in the current fuel consumption.

When the range falls below 20 miles (30 km), dashes are displayed. After filling with at least 5 litres of fuel, the range is recalculated and is displayed when it exceeds 60 miles (100 km).

! If dashes are displayed continuously while driving in place of the digits, contact a PEUGEOT dealer or a qualified workshop.



Current fuel consumption

(mpg or l/100 km or km/l)

Calculated over the last few seconds.

i This function is only displayed from 20 mph (30 km/h).



Average fuel consumption

(mpg or l/100 km or km/l)

Calculated since the last trip computer reset.



Average speed

(mph or km/h)

Calculated since the last trip computer reset.



Distance travelled

(miles or km)

Calculated since the last trip computer reset.



Distance remaining to destination

(miles or km)

This is the distance remaining to be travelled to the final destination. It is either calculated instantly by the navigation system, if guidance is activated, or entered by the user.

If the distance is not entered, dashes are displayed in place of the digits.



Stop & Start time counter

(minutes / seconds or hours / minutes)

If your vehicle is fitted with Stop & Start, a time counter calculates the time spent in STOP mode during a journey.

It resets to zero every time the ignition is switched on with the key.

Remote control key

System which permits central unlocking or locking of the vehicle using the lock or from a distance. It is also used to locate and start the vehicle, as well as providing protection against theft.

Unlocking the vehicle



Unfolding the key

- ☞ First press this button to unfold the key.

Complete unlocking using the remote control



- ☞ Press the open padlock to unlock the vehicle.

Complete unlocking using the key

- ☞ Turn the key forwards in the driver's door lock to unlock the vehicle.

Selective unlocking using the remote control



- ☞ Press the open padlock once to unlock the driver's door only.
- ☞ Press the open padlock again to unlock the other doors and the boot.

Selective unlocking using the key

- ☞ Turn the key to the left in the driver's door lock once to unlock the driver's door only.
- ☞ Turn the key to the left in the driver's door lock again to unlock the other doors and the boot.

The selective unlocking is only available on versions fitted with deadlocking.



The complete or selective unlocking parameter is set via the vehicle configuration menu.

Complete unlocking is activated by default.

- i** The direction indicators flash for a few seconds. According to version, the door mirrors unfold, the welcome lighting comes on and the alarm is deactivated.

Locking the vehicle

Normal locking using the remote control



- ☞ Press the closed padlock to lock the vehicle completely.

- ☞ Press the closed padlock for more than two seconds to close the windows automatically in addition to locking (according to version).

Normal locking using the key

- ☞ Turn the key to the right in the driver's door lock to lock the vehicle completely.

- i** The direction indicators come on for a few seconds. Depending on version, the door mirrors fold at the same time, the alarm is activated.

- i** If one of the doors or the boot is not fully closed, locking does not take place. However, the alarm (if fitted) will be fully activated after about 45 seconds. If the vehicle is unlocked inadvertently and with no action then on the doors or boot, it will relock automatically after about thirty seconds. If the alarm had been activated previously, it will not be reactivated automatically.

- i** The folding and unfolding of the door mirrors using the remote control can be deactivated by a PEUGEOT dealer or a qualified workshop.

Deadlocking using the remote control



- ☞ Press the closed padlock to lock the vehicle completely or press the closed padlock for more than two seconds to close the windows automatically in addition to locking (according to version).
- ☞ Press the closed padlock again within five seconds to deadlock the vehicle.

Deadlocking using the key

- ☞ Turn the key to the right in the driver's door lock to lock the vehicle completely and hold it in this position for more than two seconds to close the windows automatically in addition to locking (according to version).
- ☞ Turn the key to the right again within five seconds to deadlock the vehicle.

Deadlocking is confirmed by fixed lighting of the direction indicators for approximately two seconds.

! According to version, the door mirrors fold at the same time. Deadlocking renders the exterior and interior door controls inoperative. It also deactivates the manual central control button. Therefore, never leave anyone inside the vehicle when it is deadlocked.

Folding the key

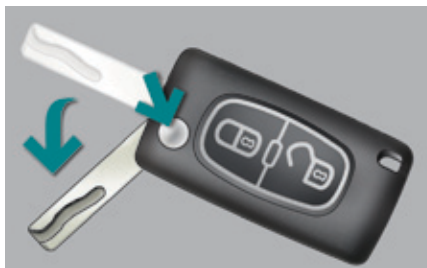

- ☞ First press this button to fold the key.

i If you do not press the button when folding the key, there is a risk of damage to the mechanism.

Locating your vehicle



- ☞ Press the closed padlock to locate your locked vehicle in a car park.

This is indicated by lighting of the direction indicators for a few seconds.

Remote control problem

Following disconnection of the vehicle battery, replacement of the remote control battery or in the event of a remote control malfunction, you can no longer unlock, lock or locate your vehicle.

- ☞ First of all, use the key in the lock to unlock or lock your vehicle.
- ☞ Then, reinitialise the remote control.

Reinitialisation

- ☞ Switch off the ignition.
- ☞ Turn the key to position **2 (Ignition on)**.
- ☞ Press the closed padlock immediately for a few seconds.
- ☞ Switch off the ignition and remove the key from the ignition switch.

The remote control is fully operational again.

! If the problem persists, contact a PEUGEOT dealer as soon as possible.

Changing the battery

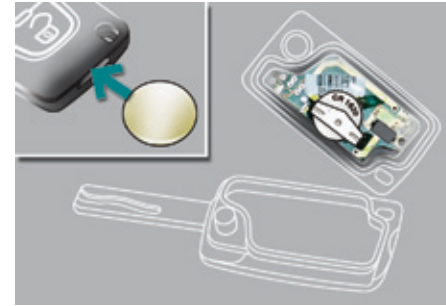

Battery ref.: CR1620 / 3 volts.



If the battery is flat, you are informed by illumination of this warning lamp, an audible signal and a message.

- ☞ Unclip the casing using a coin at the notch.
- ☞ Slide the flat battery out of its location.
- ☞ Slide the new battery into its location observing the original direction.
- ☞ Clip the casing.
- ☞ Reinitialise the remote control.

! Lost keys

Go to a PEUGEOT dealer with the vehicle's registration document, your personal identification documents and if possible the key code label.

The PEUGEOT dealer will be able to look up the key code and the transponder code required to order a new key.

Remote control

The high frequency remote control is a sensitive system; do not operate it while it is in your pocket as there is a possibility that it may unlock the vehicle, without you being aware of it. Do not repeatedly press the buttons of your remote control out of range and out of sight of your vehicle. You run the risk of stopping it from working and the remote control would have to be reinitialised.

No remote control can operate when the key is in the ignition switch, even when the ignition is switched off, except for reinitialisation.

Locking the vehicle

Driving with the doors locked may make access to the passenger compartment by the emergency services more difficult in an emergency.

As a safety precaution, never leave children alone in the vehicle, except for a very short period.

In all cases, it is essential to remove the key from the ignition switch when leaving the vehicle.

Anti-theft protection

Do not make any modifications to the electronic engine immobiliser system; this could cause malfunctions.

When purchasing a second-hand vehicle

Have the pairing of all of the keys in your possession checked by a PEUGEOT dealer, to ensure that only your keys can be used to open and start the vehicle.



Do not throw the remote control batteries away, they contain metals which are harmful to the environment. Take them to an approved collection point.

Alarm

System which protects and provides a deterrent against the theft of your vehicle. It provides two types of protection, exterior and interior, as well as an anti-tamper function.

Exterior perimeter protection

The system detects opening of the vehicle. The alarm is triggered if anyone tries to enter the vehicle by forcing a door, the boot or the bonnet.

Interior volumetric protection

The system detects any variation in the volume in the passenger compartment. The alarm is triggered if anyone breaks a window or moves inside the vehicle. If you wish to leave a pet in the vehicle or a window partially open, deactivate the interior volumetric protection.

Anti-tamper function

The system detects the putting out of service of its components. The alarm is triggered if anyone tries to put the wires of the siren, the central control or the battery out of service.

! Do not make any modifications to the alarm system, this could cause malfunctions.

Locking the vehicle with full alarm

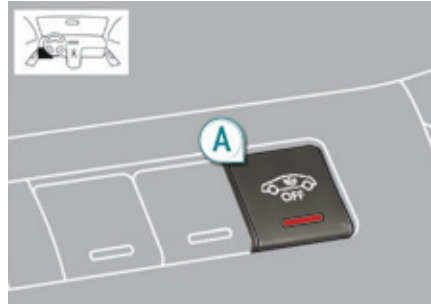

Activation

- ☞ Switch off the ignition and get out of the vehicle.
- ☞ Lock or deadlock the vehicle using the locking button on the remote control.

The alarm is activated; the indicator lamp in button **A** flashes once per second.

i If a door, the boot or the bonnet is not fully closed, the vehicle is then not locked, but perimeter monitoring will be active after a period of 45 seconds, at the same time as the volumetric monitoring.

Deactivation

- ☞ Unlock the vehicle using the unlocking button on the remote control.

The alarm is deactivated; the indicator lamp in button **A** switches off.

i In the event of automatic relocking of the vehicle (occurs after an unintentional unlocking followed by a period of 30 seconds without opening a door or the boot), the monitoring system is not reactivated automatically. To reactivate the system, it is necessary to unlock the vehicle and then lock it again using the key or the remote control.

Locking the vehicle with exterior protection alarm only

Deactivation of the interior volumetric protection

- ☞ Switch off the ignition.
- ☞ Within ten seconds, press button **A** until the indicator lamp is on continuously.
- ☞ Get out of the vehicle.
- ☞ Lock or deadlock the vehicle using the locking button on the remote control.

The exterior protection alarm alone remains activated; the indicator lamp in button **A** flashes once per second.

i To be effective, this deactivation must be carried out each time the ignition is switched off.

Reactivation of the interior volumetric protection

- ☞ Unlock the vehicle using the unlocking button on the remote control.
- ☞ Relock the vehicle using the remote control.

The alarm is activated again with both types of protection; the indicator lamp in button **A** switches off.

Triggering

This is indicated by sounding of the siren and flashing of the direction indicators for approximately thirty seconds. After it has been triggered, the alarm is again operational.

! If the alarm is triggered ten times in succession, the eleventh time will result in it becoming inactive. If the indicator lamp in button **A** flashes rapidly, this indicates that the alarm was triggered during your absence. When the ignition is switched on, this flashing stops immediately. To avoid triggering the alarm when washing your vehicle, lock it using the key in the driver's door lock. Do not activate the alarm before disconnecting the battery, otherwise the siren will sound.

Failure of the remote control

- ☞ Unlock the vehicle using the key in the driver's door lock.
- ☞ Open the door; the alarm is triggered.
- ☞ Switch on the ignition; the alarm stops.

Locking the vehicle without activating the alarm

- ☞ Lock or deadlock the vehicle using the key in the driver's door lock.

The direction indicators do not come on.

Malfunction

When the ignition is switched on, illumination the indicator lamp in button **A** for ten seconds indicates a siren fault.

Have it checked by a PEUGEOT dealer or a qualified workshop.

Automatic operation*

Depending on the legislation in force in your country, one of these cases may occur:

- 45 seconds after the vehicle is locked using the remote control, the alarm is activated, regardless of the status of the doors and boot.
- 2 minutes after the last door or the boot is closed, the alarm is activated.
 - ☞ To avoid triggering the alarm on entering the vehicle, first press the unlocking button on the remote control.

* According to country.

Electric windows

System intended to open or close a window manually or automatically. Fitted with a safety anti-pinch system and a system for deactivation in the event of misuse of the rear controls.

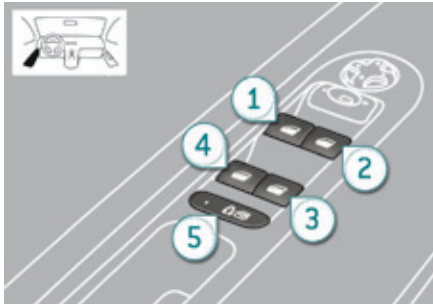

1. **Driver**
2. **Passenger**
3. **Rear right**
4. **Rear left**
5. **Deactivation of the rear electric windows and doors.**

One-touch electric windows

Manual mode

- ☞ Press or pull the control gently. The window stops when the control is released.

Automatic mode

- ☞ Press or pull the control firmly. The window opens or closes fully when the control is released.
- ☞ Pressing the control again stops the movement of the window.

i The electric window controls remain operational for approximately 45 seconds after the ignition is switched off or until the vehicle is locked after a front door is opened. If one of the passenger windows cannot be operated from the driver's door control panel, carry out the operation from the control pad of the passenger door concerned, and vice versa.

! After approximately ten consecutive complete opening/closing movements of the window, a protection function is activated to prevent damage to the electric window motor. After this, you have approximately one minute in which to close the window. Once the window is closed, the controls will become operational again after approximately 40 minutes.

Safety anti-pinch

When the window rises and meets an obstacle, it stops and partially lowers again.

i If the window cannot be closed (for example, in the presence of ice), immediately after the movement is reversed:

- ☞ Press and hold the control until the window opens fully.
- ☞ Then pull the control immediately and hold it until the window closes.
- ☞ Continue to hold the control for approximately one second after the window has closed.

The safety anti-pinch function is not operational during these operations.

Reinitialisation

If a window does not rise automatically or following disconnection of the battery, the anti-pinch function must be reinitialised.

For each window:

- ☞ Pull the control until the window stops.
- ☞ Release the control and pull it again, repeat these operations until the window closes fully.
- ☞ Continue to hold the control for approximately one second after the window has closed.
- ☞ Press the control to lower the window automatically to the low position.
- ☞ Once the window has reached the low position, press the control again for approximately one second.

The safety anti-pinch function is not operational during these operations.

Deactivation of the rear electric windows and doors



- ☞ For the safety of your children, with the ignition on, press control **5** to deactivate the rear electric window controls regardless of their position.

It is still possible to open the doors from the outside and operate the rear electric windows from the driver's control panel.

i Indicator lamp on, the rear controls are deactivated.
Indicator lamp off, the rear controls are activated.

! This control also deactivates the interior controls for the rear doors (see "Child lock").

! Any other status of the indicator lamp indicates a malfunction of the electric child lock. Have it checked by a PEUGEOT dealer or a qualified workshop.

Always remove the key from the ignition when leaving the vehicle, even for a short time.

If an obstacle is encountered during operation of the electric windows, you must reverse the movement of the window. To do this, press the control concerned.

When the driver operates the controls for the passengers' electric windows, they must ensure that no one is preventing correct closing of the windows.

The driver must ensure that the passengers use the electric windows correctly.

Be aware of children when operating the windows.

Doors

Opening

From outside

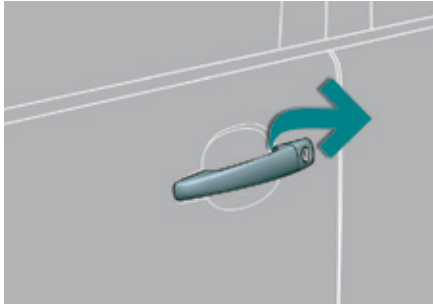

- ☞ After unlocking the vehicle completely using the remote control or the key, pull the door handle.

From inside



- ☞ Pull the door control (front or rear) to open the door; this unlocks this vehicle completely.

! The interior door controls do not operate when the vehicle is deadlocked.

Closing

When a door or the boot is not closed correctly:



- **When the engine is running**, this warning lamp comes on, accompanied by a message in the multifunction screen for a few seconds,
- **When the vehicle is moving** (speed higher than 6 mph (10 km/h)), this warning lamp comes on, accompanied by an audible signal and a message for a few seconds.

Centralised locking control

System which provides full manual locking or unlocking of the doors from the inside.

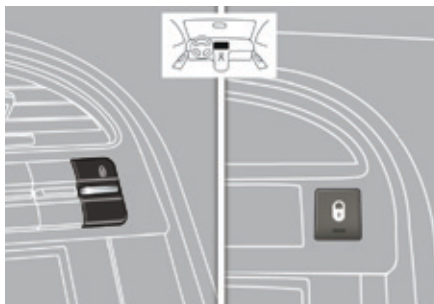

Locking

☞ Press this button to lock the vehicle.
The red indicator lamp in the button comes on.

i If one of the doors is open, the central locking from the inside does not take place.

Unlocking

☞ Press this button again to unlock the vehicle.
The red indicator lamp in the button goes off.

When locking / deadlocking from the outside

When the vehicle is locked or deadlocked from the outside, the red indicator lamp flashes and the button is inactive.

- ☞ After normal locking, pull the interior door lever to unlock the vehicle.
- ☞ After deadlocking, it is necessary to use the remote control or the key to unlock the vehicle.

Automatic central locking

System which provides full automatic locking or unlocking of the doors and boot while driving. You can activate or deactivate this function.

Activation



☞ Press this button for more than two seconds.

! A confirmation message is displayed, accompanied by an audible signal.

Deactivation

- ☞ Press this button again for more than two seconds.

A confirmation message is displayed, accompanied by an audible signal.

Automatic locking

Above 6 mph (10 km/h), the doors and boot lock automatically.

If one of the doors is open, the automatic central locking does not take place.

If the boot is open, the automatic central locking of the doors is active.

Unlocking

- ☞ Above 6 mph (10 km/h), press this button to unlock the doors and boot temporarily.



In the event of an impact, the doors unlock automatically.

Emergency control

System allowing the doors to be locked and unlocked manually in the event of a malfunction of the central locking system or battery failure.

Locking the driver's door

- ☞ Insert the key in the door lock, then turn it to the rear.

You can also apply the procedure described for the passenger doors.

Unlocking the driver's door

- ☞ Insert the key in the door lock, then turn it to the front.

Locking the front and rear passenger doors



- ☞ Open the doors.
- ☞ On the rear doors, check that the child lock is not on (see the corresponding section).
- ☞ Remove the black cap, located on the edge of the door, using the key.
- ☞ Insert the key in the socket without forcing it, then without turning it, move the latch sideways towards the inside of the door.
- ☞ Remove the key and refit the cap.
- ☞ Close the doors and check that the vehicle has locked correctly from the outside.

Unlocking the front and rear passenger doors

- ☞ Pull the interior door opening control.

BOOT

Opening



- After unlocking the vehicle using the remote control or the key, pull the handle and raise the tailgate.

Closing



- Lower the tailgate using the interior grab handle.

If the tailgate is not closed correctly:



- **when the engine is running**, this warning lamp comes on, accompanied by a message in the multifunction screen for a few seconds,
- **when the vehicle is moving** (speed above 6 mph (10 km/h)), this warning lamp comes on, accompanied by an audible signal and a message in the multifunction screen for a few seconds.

i When selective unlocking is activated, the boot can also be opened by a second press on the open padlock on the remote control.

Tailgate release

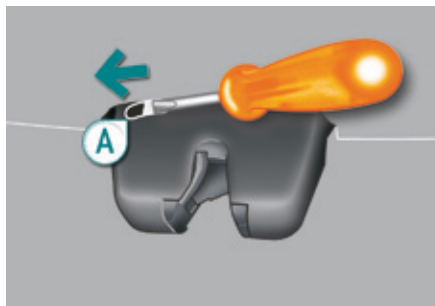

System allowing the mechanical unlocking of the boot in the event of a battery or central locking system malfunction.

Unlocking

- ☞ Fold back the rear seats to gain access to the lock from inside the boot.
- ☞ Insert a small screwdriver into hole **A** of the lock to unlock the tailgate.
- ☞ Move the latch to the left.

Locking after closing

If the fault persists after closing again, the boot will remain locked.

Heating and Ventilation

System which creates and maintains good conditions of comfort and visibility in the vehicle's passenger compartment.

Air intake

The air circulating in the passenger compartment is filtered and originates either from the outside via the grille located at the base of the windscreen or from the inside in air recirculation mode.

Controls

The incoming air follows various routes depending on the controls selected by the driver, the front passenger and rear passengers, according to the level of equipment.

The temperature control enables you to obtain the level of comfort required by mixing the air of the various circuits.

The air distribution control enables you to select the air vents used in the passenger compartment by the combined use of the associated buttons.

The air flow control enables you to increase or reduce the speed of the ventilation fan. These controls are grouped together on control panel **A** on the centre console.

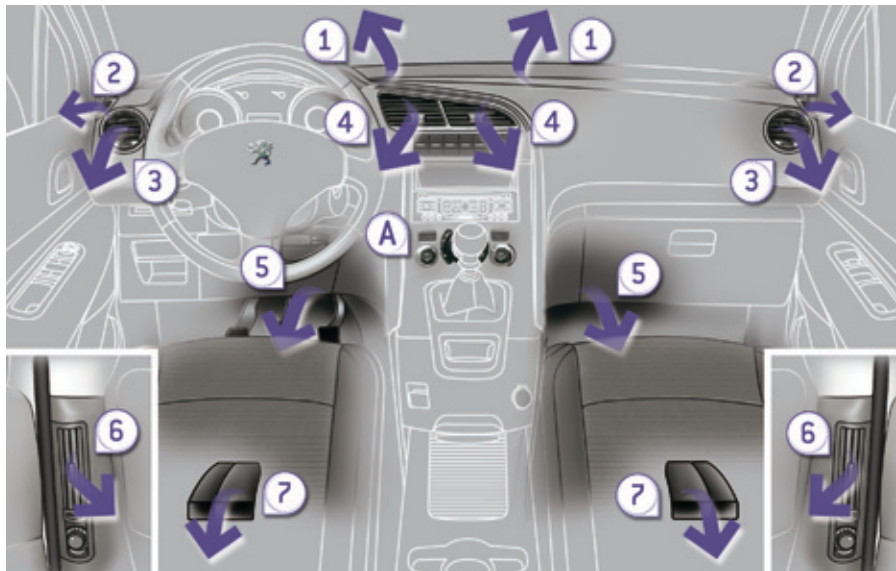

Air distribution

1. Windscreen demisting/defrosting vents.
2. Front side window demisting/defrosting vents.
3. Side adjustable air vents.
4. Central adjustable air vents.
5. Air outlets to the front footwells.
6. Adjustable air vents for the rear passengers.
7. Air outlets to the rear footwells.

i Recommendations for ventilation and air conditioning

In order for these systems to be fully effective, follow the operation and maintenance guidelines below:

- ☞ If the interior temperature remains very high after the vehicle has been parked in the sun for a considerable time, first ventilate the passenger compartment for a few minutes. Place the air flow control at a sufficient level to provide an adequate renewal of air in the passenger compartment.
- ☞ To obtain an even air distribution, take care not to obstruct the exterior air intake grilles located at the base of the windscreen, the nozzles, the vents and the air outlets, as well as the air extractor located in the boot.
- ☞ Use in preference the intake of exterior air as prolonged use of the air recirculation may cause misting of the windows and side windows.
- ☞ Do not cover the sunshine sensor, located on the dashboard; this is used for regulation of the automatic air conditioning system.
- ☞ Operate the air conditioning system for 5 to 10 minutes, once or twice a month to keep it in good working order.
- ☞ Ensure that the passenger compartment filter is in good condition and have the filter elements replaced regularly (refer to the "Checks" section).
We recommend the use of a combined passenger compartment filter. Thanks to its second special active filter, it contributes to the purification of the air breathed by the occupants and the cleanliness of the passenger compartment (reduction of allergic symptoms, bad odours and greasy deposits).
- ☞ The air conditioning uses power from the engine while operating. This results in an increase in the vehicle's fuel consumption.

When towing at or near maximum capacity or on steep slopes in high ambient temperatures, switching off the air conditioning saves engine power and so improves towing capacity.

Condensation created by the air conditioning results in a discharge of water under the vehicle when stationary, which is perfectly normal.

- ☞ To ensure correct operation of the air conditioning system, you are also advised to have it checked regularly.
- ☞ If the system does not produce cold air, do not use it and contact a PEUGEOT dealer or a qualified workshop.

 The air conditioning system does not contain chlorine and does not present any danger to the ozone layer.

Rear ventilation adjustment



After pressing the "REAR" button, turn the adjustment dial of the rear side vents to decrease or increase the flow of air.

Take care not to obstruct the side vents and the air outlets on the floor.

To shut off the flow of air, close the vents and set the dial to 0.

Manual air conditioning



The air conditioning can only operate with the engine running.

1. Temperature adjustment



- ☞ Turn the dial from blue (cold) to red (hot) to adjust the temperature to your requirements.

2. Air flow adjustment



- ☞ Turn the dial from position 1 to position 5 to obtain a comfortable air flow.

- i** ☞ If you place the air flow control in position 0 (deactivation of the system), the temperature is no longer maintained at a comfortable level. However, a slight flow of air, due to the movement of the vehicle, can still be felt.

3. Air distribution adjustment



Windscreen and side windows.



Windscreen, side windows and front-rear footwells.



Footwells, front-rear (closing the vents increases the flow to the footwells).



Central, side and rear vents.



The air distribution can be adapted by placing the dial in an intermediate position.

4. Air intake / Air recirculation

The intake of exterior air limits misting of the windscreen and side windows.

The recirculation of interior air insulates the passenger compartment from exterior odours and smoke.

Return to exterior air intake as soon as possible to prevent deterioration of the air quality and demisting performance.



- ☞ Press the button to recirculate the interior air. The indicator lamp comes on to confirm this.

- ☞ Press the button again to permit the intake of exterior air. The indicator lamp goes off to confirm this.

Demisting/defrosting



The marking on the control panel indicates the position of the controls to quickly demist or defrost the windscreen and side windows:

- ☞ place the air intake control **4** in the "Exterior air intake" position (indicator lamp off),
- ☞ place the air distribution dial **3** in the "Windscreen position",
- ☞ place the air flow dial **2** in position 5 (maximum),
- ☞ place the temperature dial **1** in the red position (hot).

i With Stop & Start, when demisting has been activated, the STOP mode is not available.

5. Air conditioning On / Off



The air conditioning is designed to operate effectively in all seasons, with the windows closed.

It enables you to:

- lower the temperature, in summer,
- increase the effectiveness of the demisting in winter, above 3 °C.

Switching on

- ☞ Press the "A/C" button, the button's indicator lamp comes on.
- The air conditioning does not operate when the air flow adjustment control **2** is in position "0". To obtain cooled air more quickly, you can use recirculation of interior air for a few moments. Then return to fresh air intake.

Switching off

- ☞ Press the "A/C" button again, the button's indicator lamp goes off.
- Switching off may affect comfort levels (humidity, condensation).

Rear screen demist - defrost



The control button is located on the air conditioning system control panel.

Switching on

The rear screen demist - defrost can only operate when the engine is running.

- ☞ Press this button to demist/defrost the rear screen and, depending on version, the door mirrors. The indicator lamp associated with the button comes on.

Switching off

The demist/defrost switches off automatically to prevent an excessive consumption of current.

- ☞ It is possible to stop the demist/defrost operation before it is switched off automatically by pressing the button again. The indicator lamp associated with the button goes off.



Switch off the demist/defrost of the rear screen and door mirrors as soon as it is no longer needed as lower current consumption results in reduced fuel consumption.

Dual-zone digital air conditioning

The air conditioning only operates when the engine is running.

Automatic operation



1. Automatic comfort programme



- ☞ Press the **"AUTO"** button. The indicator lamp on the button comes on.

We recommend the use of this mode: it permits automatic and optimised adjustment of all of the functions, passenger compartment temperature, air flow, air distribution and air recirculation, in accordance with the comfort value that you have chosen.

This system is designed to operate effectively in all seasons, with the windows closed.

i When the engine is cold, to prevent too great a distribution of cold air, the air flow will reach its optimum level gradually. In cold weather, it favours the distribution of warm air to the windscreen, side windows and footwells only.

2-3. Driver-passenger side adjustment



The driver and front passenger can each adjust the temperature to their requirements.

The value indicated on the display corresponds to a level of comfort and not to a temperature in degrees Celsius or Fahrenheit.

- ☞ Turn control **2** or **3** to the left or to the right respectively to decrease or increase this value.

A setting around the value 21 provides optimum comfort. However, depending on your requirements, a setting between 18 and 24 is normal.

You are advised to avoid a left / right setting difference of more than 3.

i On entering the vehicle, if the interior temperature is much colder or warmer than the comfort value, there is no need to change the value displayed in order to obtain the comfort required more quickly. The system corrects the difference in temperature automatically and as quickly as possible.

4. Automatic visibility programme



The automatic comfort programme may not be sufficient to quickly demist or defrost the windscreen and side windows (humidity, several passengers, ice, etc.).

- ☞ In this case, select the automatic visibility programme.

The system automatically controls the air conditioning, the air flow and the air intake and provides optimum distribution of the ventilation to the windscreen and side windows.

- ☞ To switch it off, press the **"visibility"** button again or press the **"AUTO"** button, the indicator lamp in the button goes off or the indicator lamp on the **"AUTO"** button comes on.

Manual operation

If you wish, you can make a different choice from that offered by the system by changing a setting. The other functions will still be controlled automatically.

- ☞ Pressing the **"AUTO"** button returns the system to completely automatic operation.

i For maximum cooling or heating of the passenger compartment, it is possible to exceed the minimum value 14 or the maximum value 28.

- ☞ Turn control **2** or **3** to the left until **"LO"** (low) is displayed or to the right until **"HI"** (high) is displayed.

5. Air conditioning On / Off



- ☞ Press this button to switch off the air conditioning.

Switching the system off could result in discomfort (humidity, condensation).

- ☞ Press this button again to return to automatic operation of the air conditioning. The indicator lamp in the **"A/C"** button comes on.

To obtain cool air sooner, you can use air recirculation for a few moments. Then return to exterior air intake.

In winter, we recommend that you close the rear vents.

6. Air distribution adjustment



- ☞ Press one or more buttons to direct the air flow towards:

- the windscreen and side windows (demisting or defrosting),
- the windscreen, the side windows and the vents,
- the windscreen, the side windows, the vents and the footwells,
- the vents and the footwells,
- the vents,
- the footwells,
- the windscreen, the side windows and the footwells.

7. Air flow adjustment



- ☞ Turn this control to the left to decrease the air flow or to the right to increase the air flow.

The air flow indicator lamps, between the two fans, come on progressively according to the value requested.

i With Stop & Start, when demisting has been activated, the STOP mode is not available.

8. Air recirculation



- ☞ Press this button to recirculate the interior air. The indicator lamp comes on.



- Air closed/intake (automatic mode). Press this button, the warning lamp comes on.



- Forced closing of the air intake (manual mode). Press this button to recirculate the interior air, the warning lamp come on.

Air recirculation enables the passenger compartment to be isolated from exterior odours and smoke.

- ☞ As soon as possible, press the "auto" button to allow the intake of exterior air and avoid the misting of windows.

9. Rear ventilation (Rear)



- ☞ Press this button to allow the air to circulate towards the rear. The temperature will be equal to the left-hand comfort value for the rear left passengers and equal to the right-hand comfort value for the rear right passengers. The indicator lamp in the button comes on.

Switching the system off/on

- ☞ Turn the air flow control to the left until all of the indicator lamps go off.

This action switches off all of the functions of the system.

Temperature related comfort is no longer guaranteed but a slight flow of air, due to the movement of the vehicle, can still be felt.

- ☞ Turn the air flow dial to the right or press the "AUTO" button to reactivate the system with the values set before it was switched off.

! Avoid driving for prolonged periods with the system off.

Front seats with manual adjustments

Seat consisting of a seat cushion, a seat back and a head restraint which can all be adjusted to adapt your position for ease of driving and comfort.

Forwards-backwards

- ☞ Raise the control and slide the seat forwards or backwards.



Height

- ☞ Pull the control upwards to raise or push it downwards to lower, as many times as required, to obtain the position required.

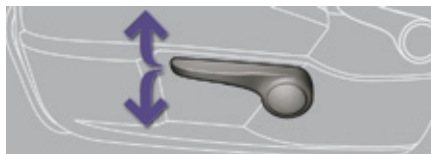

Backrest angle

- ☞ Push the control rearwards.



- !** Before moving the seat backwards, ensure that there is nothing that might prevent the full travel of the seat, so as to avoid the risk of jamming the seat caused by the presence of objects on the floor behind the seat or rear passengers. If the seat jams, stop the movement immediately.

Driver's electric seat

Seat consisting of a seat cushion, a seat back and a head restraint which can all be adjusted to adapt your position for ease of driving and comfort.

Forwards-backwards

- ☞ Push the control forwards or rearwards to slide the seat.



Cushion height and angle

- ☞ Tilt the rear part of the control upwards or downwards to obtain the required height.
- ☞ Tilt the front part of the control upwards or downwards to obtain the required angle.

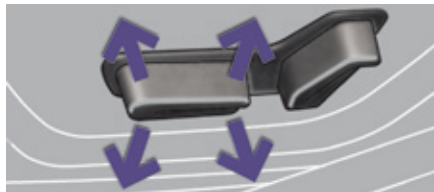

Backrest angle

- ☞ Tilt the control forwards or rearwards to adjust the angle of the seat back.

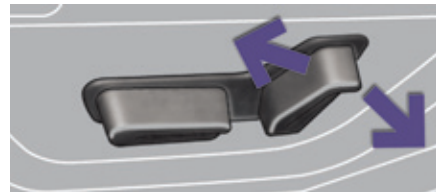

Head restraint height and angle adjustment

i The electric functions of the driver's seat are active for approximately one minute after opening the front door. They are deactivated approximately one minute after the ignition is switched off and in economy mode. To reactivate them, switch on the ignition.

! Before moving the seat backwards, ensure that there is nothing that might prevent the full travel of the seat, so as to avoid the risk of jamming the seat caused by the presence of objects on the floor behind the seat or rear passengers. If the seat jams, stop the movement immediately.

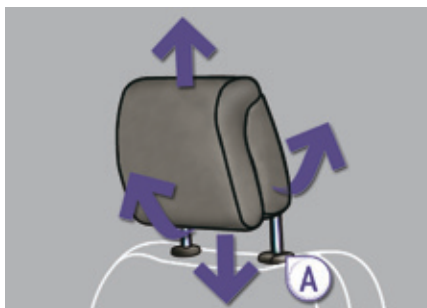

- ☞ To raise the head restraint, pull it forwards and upwards at the same time.
- ☞ To remove the head restraint, press the lug **A** and pull the head restraint upwards.
- ☞ To put the head restraint back in place, engage the head restraint stems in the openings keeping them in line with the seat back.
- ☞ To lower the head restraint, press the lug **A** and the head restraint at the same time.
- ☞ To adjust the angle of the head restraint, tilt its lower part forwards or rearwards.

! The head restraint is fitted with a frame with notches which prevents it from lowering; this is a safety device in case of impact.

The adjustment is correct when the upper edge of the head restraint is level with the top of the head.

Before moving off, check the adjustment of the head restraint; adjust it if the seat has been occupied by someone of different size.

Never drive with the head restraints removed; they must be in place and adjusted correctly.

Manual lumbar adjustment

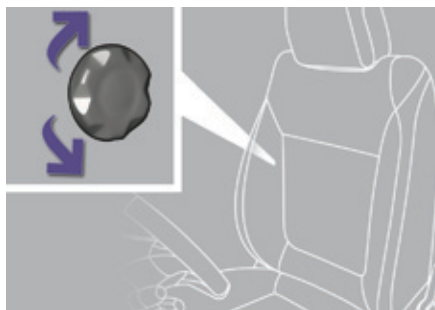

- ☞ Turn the knob manually to obtain the desired level of lumbar support.

Heated seats control



With the engine running, the front seats can be heated separately.

- ☞ Use the adjustment dial, placed on the side of each front seat, to switch on and select the level of heating required:

- 0:** Off.
- 1:** Low.
- 2:** Medium.
- 3:** High.

Table position, front passenger seat

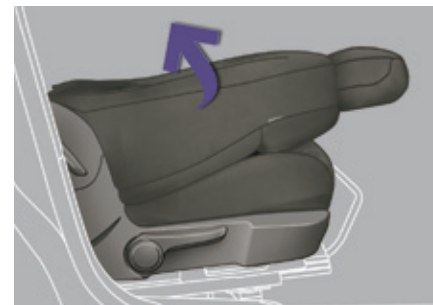
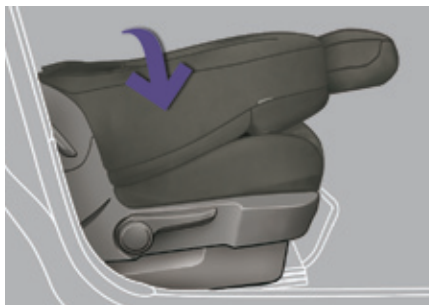
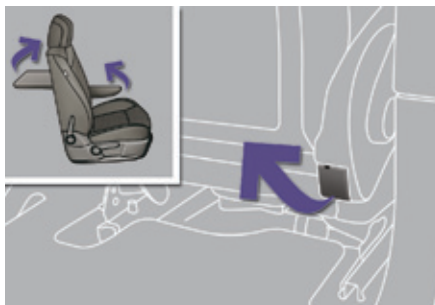

Folding the seat backrest

- ☞ Raise the armrest and fold up the "aircraft" style table, fixed on the back of the seat.
- ☞ Check that no object, either on or underneath the seat, could hinder its movement.
- ☞ To make the operation easier, place the head restraint in the low position (if the seat is in the fully forward position).
- ☞ If your vehicle is fitted with the video pack, place the protective cover on the head restraint.
- ☞ Lift the control, located behind the seat, then guide the seat back forwards.

This position, associated with that of the rear seats, allows you to transport long objects inside the vehicle.
The maximum weight on the seat is 30 kg.

Returning the seat to the normal position

- ☞ Guide the seat backrest rearwards until it locks in place.

! When the seat backrest is in this position, only the 2nd row passenger seat located behind the driver can be used.



3

Rear head restraints

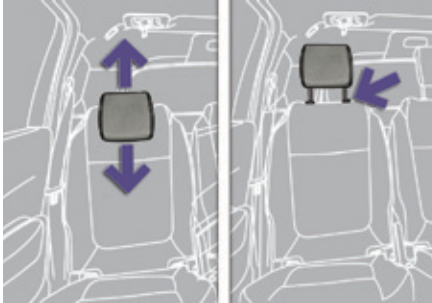

The rear head restraints can be removed and have two positions:

- high, position for use,
- low, storage position.

To raise a head restraint, pull it upwards.

To lower it, press the lug then the head restraint.

To remove it, place it in the high position, push the lug and pull it upwards.

To refit it, engage the head restraint rods in the holes taking care to remain in line with the seat back.

! Never drive with the head restraints removed, they must be in place and correctly adjusted.

2nd row seats

Forwards-backwards adjustment

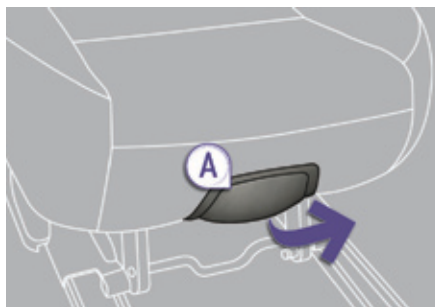

Lift the control **A**, located at the front of the seat, then adjust the seat to the position desired.

"Comfort" position

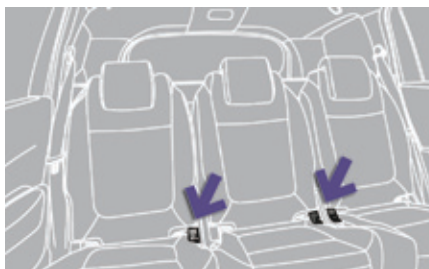

The three 2nd row seats are independent of each other and all the same width. They all have a "comfort" position.

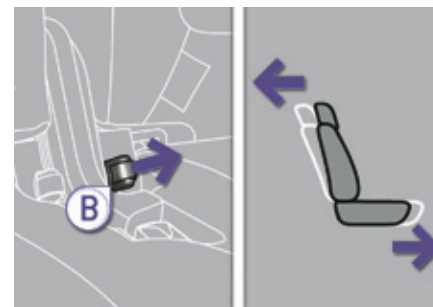

Placing a seat in the "comfort" position

☞ Pull on the control **B** and guide the seat rearwards.

The backrest reclines and the seat base moves forward slightly.

Returning the seat to the initial position

☞ Pull on the control **B** and allow the seat to come forwards.

! Always supervise any movements of seats by children.

3

Flat floor

Each seat can be folded onto the floor to enable you to modify your vehicle's interior space.

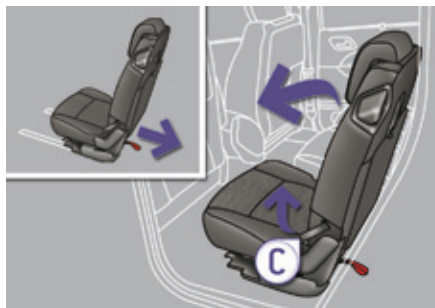

Folding the seat from the 2nd row

- ☞ Place the seats as far towards the rear as possible.
- ☞ Pull firmly upwards on strap **C**, to unlock the seat; keep pulling until the seat is fully folded.
- ☞ Push the backrest slightly forwards so that the backrest pivots, folding onto the seat base. The assembly then lowers onto the floor.

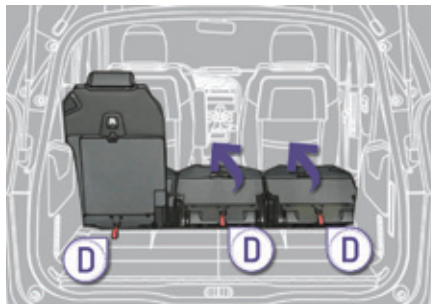

Folding the seat from the boot

When loading, for example, you can fold the seat or seats directly from the boot, once you have folded the 3rd row seats (7 seat version).

- ☞ Place the seats as far towards the rear as possible.
- ☞ Pull on the strap **D** to release the chosen seat and push the backrest gently forwards.

i To avoid damaging the mechanism, the strap **D** unclips under excessive force. Simply reclip it to restore the system to working order.

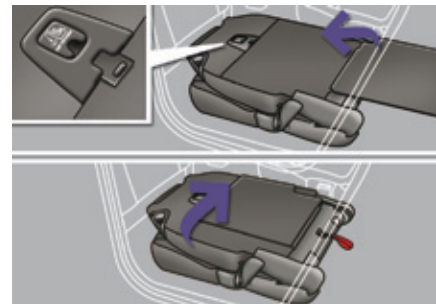

Repositioning seat

- ☞ If necessary, return the 2nd row seat rigid panels to their initial position and lock them.
- ☞ Raise the backrest and push it rearwards until it locks.

! Before moving the 3rd row seats (7 seat version), return the 2nd row seat rigid panels to their initial position and lock them.

Emergency exit: if the first system (strap **C**) fails, strap **D** enables the 3rd row passengers to exit quickly.

Supervise any movement of seats by children.

Rigid panel

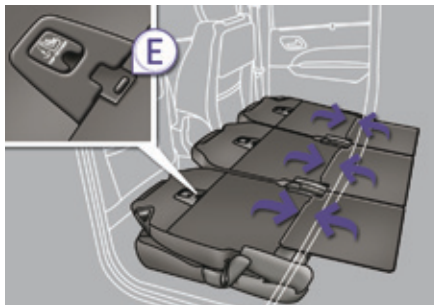

Each 2nd row seat backrest has a rigid panel attached.

This panel enables you:

- to have a continuous load surface in the boot, whatever the positions of the seats,
- to avoid having objects sliding under the 2nd row seats. 30 kg maximum on each panel.

Releasing / Locking the rigid panel

- ☞ Before deploying the rigid panels, check that the 2nd row seats are positioned as far towards the rear as possible.
- ☞ Slide the latch **E** on the panel upwards, to release it.
- ☞ Return the panel to its initial position, then slide the latch **E** downwards, to lock it in place.

Entering / Exiting the 3rd row (7 seat version)

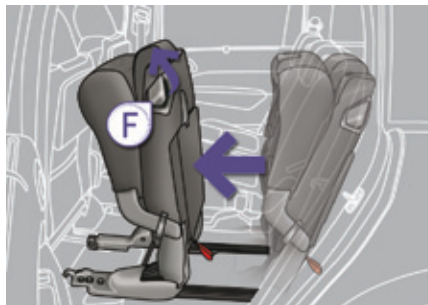

- ☞ Raise the aircraft style table on the 2nd row seat if it is down.
- ☞ Hold the control **F** in the raised position, the seat unlocks and the seat base comes up against the backrest.
- ☞ Push the seat backrest forwards, holding the control **F** forwards.

Repositioning the seat, from the outside, with the door open

If there are passengers seated in the 3rd row (7 seat version):

- ☞ Manually return the assembly as far as possible rearwards; the seat does not return as far as the maximum rearwards position so as to retain leg space for the 3rd row passengers.
- ☞ Fold the seat base.

3rd row seats (7 seat version)

Concertina boards

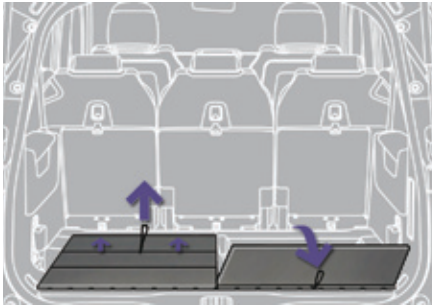

Two rigid concertina boards, which cannot be separated from the vehicle, cover the two 3rd row seats, when these are in the folded position.

Folding the concertina boards

☞ Pull on the control, the 3 sections of the board will fold like a concertina.

When the 3rd row seats are upright, these concertina boards can be left either:

- flat behind the seats,
- in the vertical position,

thereby leaving a storage area available. The two rigid boards can each support a maximum of 100 kg.

Installing a seat

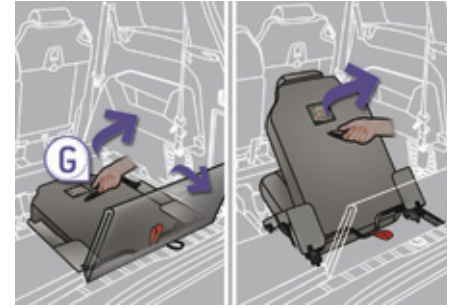

- ☞ Remove the load space screen.
- ☞ If necessary, return the 2nd row rigid panels to their initial position and lock them.
- ☞ Correctly position the concertina board vertically behind the seat.
- ☞ Pull on the control **G**, located behind the seat backrest. The backrest tilts rearwards pulling the seat base with it. The seat locks in the open position.

Storing a seat



- ☞ Lower the head restraints.
- ☞ Correctly position the concertina board vertically behind the seat.
- ☞ Pull on the control **H**, located at the bottom of the seat backrest. The seat is released.
- ☞ Next push the backrest gently forwards. The backrest pivots folding onto the seat base. The seat base then folds into the stowage area provided for that purpose.
- ☞ Reposition the concertina boards over the folded seats.

! Before moving the 3rd row seats, return the rigid panels of the 2nd row seats to the upright position and lock them in place.

Do not try to fold a 3rd row seat that has not first had the backrest fully locked in place.

Do not leave objects either on or underneath the seat bases of the 3rd row seats when you are folding them.

Do not leave your hand on the control **H** as you fold the seats, as you risk trapping your fingers.

Seat modularity and the various seat configurations

Designed to be modular, your vehicle offers numerous seat installation and loading configurations.

Operations to change the existing configuration must only be carried out when stationary (see paragraphs "Rear seats").

Examples of configurations

7 seats



Transport (4 seats)



5 seats



Transporting long objects



Loading a large volume



Mirrors

Door mirrors



Each fitted with an adjustable mirror glass permitting the lateral rearward vision necessary for overtaking or parking. They can also be folded for parking in confined spaces.

Demisting - Defrosting

If your vehicle is fitted with heated mirrors, the demisting-defrosting operates by switching on the heated rear screen (refer to the "Rear screen demist-defrost" page).

! The rear screen demist - defrost can only operate when the engine is running.



Adjustment

- ☞ Move control **A** to the right or to the left to select the corresponding mirror.
- ☞ Move control **B** in all four directions to adjust.
- ☞ Return control **A** to the central position.

! As a safety measure, the mirrors should be adjusted to reduce the blind spots.

The objects observed are, in reality, closer than they appear. Take this into account in order to correctly judge the distance of vehicles approaching from behind.

Folding

- Automatic: lock the vehicle using the remote control or the key.
- Manual: with the ignition on, pull control **A** rearwards.

i If the mirrors are folded using control **A**, they will not unfold when the vehicle is unlocked. Pull again on control **A**.

Unfolding

- Automatic: unlock the vehicle using the remote control or the key.
- Manual: with the ignition on, pull control **A** rearwards.

i The folding and unfolding of the door mirrors using the remote control can be deactivated by a PEUGEOT dealer or a qualified workshop. Fold the mirrors when putting your vehicle through an automatic car wash.

i If necessary, it is possible to fold the mirrors manually.

Rear view mirror

Adjustable mirror providing a central rearward view.

Equipped with an anti-dazzle system, which darkens the mirror glass and reduces the nuisance to the driver caused by the sun, headlamps from other vehicles...

Manual day/night model

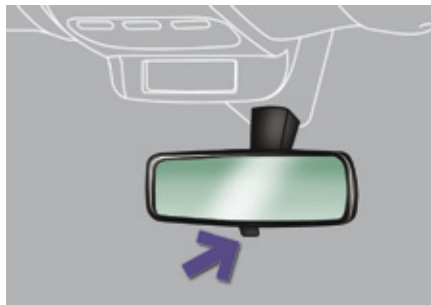

Adjustment

- ☞ Adjust the mirror so that the glass is directed correctly in the "day" position.

Day / night position

- ☞ Pull the lever to change to the "night" anti-dazzle position.
- ☞ Push the lever to change to the normal "day" position.

Automatic day/night model



By means of a sensor, which measures the light from the rear of the vehicle, this system automatically and progressively changes between the day and night uses.

i In order to ensure optimum visibility during your manoeuvres, the mirror lightens automatically when reverse gear is engaged.

Steering wheel adjustment



- ☞ **When stationary**, pull the control lever to release the adjustment mechanism.
- ☞ Adjust the height and reach to suit your driving position.
- ☞ Push the control lever to lock the adjustment mechanism.

! As a safety precaution, these operations should only be carried out with the vehicle stationary.

Lighting controls

System for selection and control of the various front and rear lamps providing the vehicle's lighting.

Main lighting

The various front and rear lamps of the vehicle are designed to adapt the lighting progressively in relation to the climatic conditions and so improve the driver's visibility:

- sidelamps, to be seen,
- dipped beam headlamps to see without dazzling other drivers,
- main beam headlamps to see clearly when the road is clear,
- directional headlamps for improved visibility when cornering.

Additional lighting

Other lamps are installed to fulfil the requirements of particular driving conditions:

- a rear foglamp to be seen from a distance,
- front foglamps for even better visibility,
- daytime running lamps to be seen during the day.

Programming

Various automatic lighting control modes are also available according to the following options:

- guide-me-home lighting,
- automatic lighting,
- directional headlamps.

i Travelling abroad

If using your vehicle in a country that drives on the other side of the road, the headlamps must be adjusted to avoid dazzling on-coming drivers. Contact an official dealer or a qualified workshop.

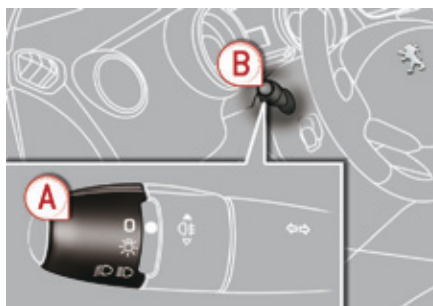

Model without AUTO lighting

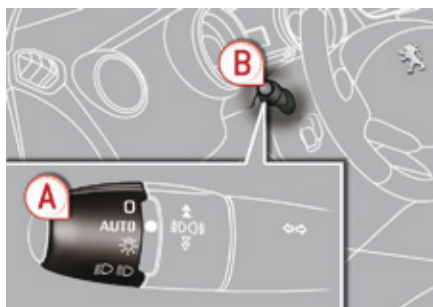

Model with AUTO lighting

Manual controls

The lighting is controlled directly by the driver by means of the ring **A** and the stalk **B**.

- A. Main lighting mode selection ring: turn it to position the symbol required facing the mark.



Lighting off / daytime running lamps.



Automatic illumination of headlamps.



Sidelamps.



Dipped headlamps or main beam headlamps.

- B. Stalk for switching headlamps: pull the stalk towards you to switch the lighting between dipped and main beam headlamps.

In the lamps off and sidelamps modes, the driver can switch on the main beam headlamps temporarily ("headlamp flash") by maintaining a pull on the stalk.

Displays

Illumination of the corresponding indicator lamp in the instrument panel confirms that the lighting selected is on.



Model with rear foglamp only

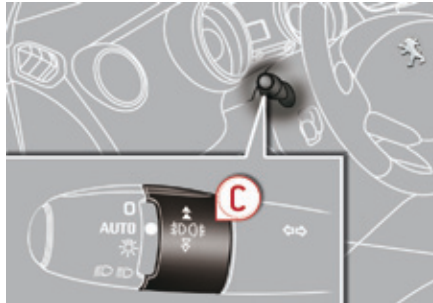

Model with front and rear foglamps

C. Foglamp selection ring.



Rear foglamp

This operates with dipped and main beam headlamps.

- ☞ To switch on the foglamp, turn the ring **C** forwards.
- ☞ To switch off the foglamp, turn the ring **C** rearwards.

When the lighting is switched on automatically (with AUTO model), the dipped beam headlamps and sidelamps remain on until the rear foglamp is switched off.



Front and rear foglamps

The rear foglamp operates with the dipped and main beam headlamps.

The front foglamps also operate with the sidelamps.

- ☞ To switch on the front foglamps, turn the ring **C** forwards.
- ☞ To switch on the rear foglamp, turn the ring **C** forwards again.
- ☞ To switch off the rear foglamp, turn the ring **C** rearwards.
- ☞ To switch off the front foglamps, turn the ring **C** rearwards again.

When the lighting is switched on automatically (with AUTO model), the dipped beam headlamps and sidelamps remain on until the rear foglamp is switched off.

When the lighting is switched off automatically (with AUTO model) or when the dipped beam headlamps are switched off manually, the foglamps and the sidelamps will remain on.

! In good or rainy weather, by both day and night, the front foglamps and the rear foglamps are prohibited. In these situations, the power of their beams may dazzle other drivers. They should only be used in fog or falling snow. In these weather conditions, you should switch on the foglamps and dipped beam headlamps manually, as the sunshine sensor may detect sufficient light.

Do not forget to switch off the front and rear foglamps when they are no longer necessary.

Switching off the lighting when switching off the ignition

When the ignition is switched off, all of the lamps switch off immediately, except for the dipped beam headlamps if automatic guide-me-home lighting is activated.

Switching on the lighting when switching on the ignition

To reactivate the lighting control stalk, turn the ring **A** to position "0" - lighting off, then to the position of your choice.

If the lighting is switched on manually after switching off the ignition, there is an audible signal when a front door is opened to warn the driver that they have forgotten to switch off the vehicle's lighting, with the ignition off.

They switch off automatically after a period which depends on the state of charge of the battery (entry to energy economy mode).

Daytime running lamps (LEDs)

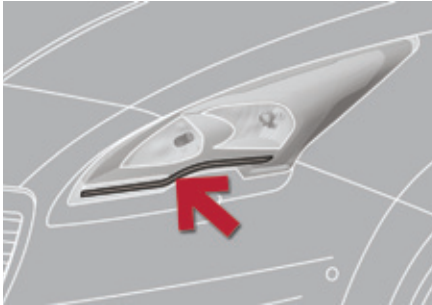

They come on automatically when the engine is started, when the lighting control stalk is in position "0" or "AUTO".

i In some weather conditions (e.g. low temperature or humidity), the presence of misting on the internal surface of the glass of the headlamps and rear lamps is normal; it disappears after the lamps have been on for a few minutes.

Manual guide-me-home lighting

The temporary illumination of the dipped beam headlamps after the vehicle's ignition has been switched off makes the driver's exit easier when the light is poor.



Switching on

- ☞ With the ignition off, "flash" the headlamps using the lighting stalk.
- ☞ A further "headlamp flash" switches the function off.

Switching off

The manual guide-me-home lighting switches off automatically after a set time.

Exterior welcome lighting

The remote switching on of the lighting makes your approach to the vehicle easier in poor light. It is activated according to the level of light detected by the sunshine sensor.

Switching on



Press the open padlock on the remote control.

The dipped beam headlamps and the sidelamps come on; your vehicle is also unlocked.

Switching off

The exterior welcome lighting switches off automatically after a set time, when the ignition is switched on or on locking the vehicle.

Programming



The lighting duration is selected via the vehicle configuration menu.

i The duration of the welcome lighting is associated with and identical to that of the automatic guide-me-home lighting.

Automatic illumination of headlamps

When a low level of ambient light is detected by a sunshine sensor, the number plate lamps, sidelamps and dipped beam headlamps are switched on automatically, without any action on the part of the driver. They can also come on if rain is detected, at the same time as automatic operation of the windscreen wipers. As soon as the brightness returns to a sufficient level or after the windscreen wipers are switched off, the lamps are switched off automatically.



Activation

- ☞ Turn the ring to the "AUTO" position. The activation of the function is accompanied by the display of a message in the screen.

Deactivation

- ☞ Turn the ring to another position. Deactivation of the function is accompanied by the display of a message in the screen.



Operating fault

In the event of a malfunction of the sunshine sensor, the lighting comes on, this warning lamp is displayed in the instrument panel and/or a message appears in the screen, accompanied by an audible signal. Contact a PEUGEOT dealer or a qualified workshop.

- ! In fog or snow, the sunshine sensor may detect sufficient light. In this case, the lighting will not come on automatically. Do not cover the sunshine sensor, coupled with the rain sensor and located in the centre of the windscreen behind the rear view mirror; the associated functions would no longer be controlled.

Automatic "guide-me-home" lighting

When the automatic illumination of headlamps function is activated (lighting control stalk in the "AUTO" position), under low ambient light the dipped beams headlamps come on automatically when the ignition is switched off.

Programming

Activation or deactivation, as well as the duration of the guide-me-home lighting, is set in the vehicle configuration menu.

Manual adjustment of halogen headlamps



To avoid causing a nuisance to other road users, the height of the halogen headlamps should be adjusted according to the load in the vehicle.

- 0.** 1 or 2 people in the front seats.
- 3 people.
- 1.** 5 people.
- Intermediate setting.
- 2.** 5 people + maximum authorised load.
- Intermediate setting.
- 3.** Driver + maximum authorised load.

i The initial setting is position "0".

i Travelling abroad

If using your vehicle in a country that drives on the other side of the road, the headlamps must be adjusted to avoid dazzling on-coming drivers. Contact a PEUGEOT dealer or a qualified workshop.

Automatic adjustment of the xenon headlamps

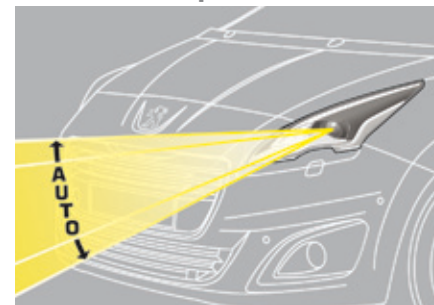

In order to avoid causing a nuisance to other road users, this system corrects the height of the xenon headlamps beam automatically and when stationary, in relation to the load in the vehicle.



If a malfunction occurs, this warning lamp is displayed on the instrument panel, accompanied by an audible signal and a message on the multifunction screen. The system then places your headlamps in the lowest position.



If a malfunction occurs, do not touch the xenon bulbs. Contact a PEUGEOT dealer or a qualified workshop.

4

Directional lighting

When the dipped or main beam headlamps are on, this function enables the light beams to provide improved lighting of the side of the road when cornering.

The use of this function, from approximately 12 mph (20 km/h) and associated with the xenon headlamps only, considerably improves the quality of your lighting when cornering.



with directional lighting



without directional lighting

Programming

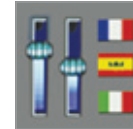

The function is activated or deactivated via the vehicle configuration menu.

Operating fault



If a fault occurs, this warning lamp flashes in the instrument panel, accompanied by a message in the screen.

Contact a PEUGEOT dealer or a qualified workshop.

i When stationary or moving at very low speed or when reverse gear is engaged, the function is inactive. The status of the function remains in the memory when the ignition is switched off.

Wiper controls

System for selection and control of the various front and rear wiping modes for the elimination of rain and cleaning.

The vehicle's front and rear wipers are designed to improve the driver's visibility progressively according to the climatic conditions.

Programming

Various automatic wiper control modes are also available according to the following options:

- automatic rain sensitive windscreen wipers,
- rear wiping on engaging reverse gear.

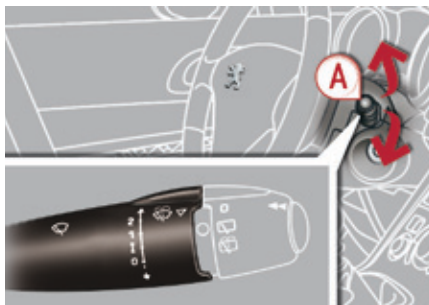

Model with intermittent wiping

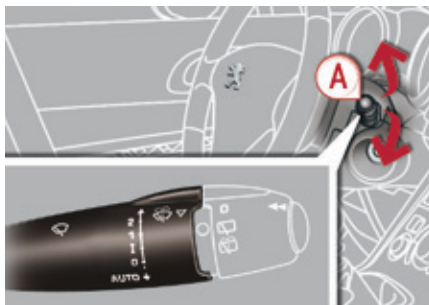

Model with AUTO wiping

Manual controls

The wiper commands are issued directly by the driver by means of the stalk **A** and the ring **B**.

Windscreen wipers

A. Wiping speed selection stalk.

- 2** Fast (heavy rain).
- 1** Normal (moderate rain).
- I** Intermittent (proportional to the speed of the vehicle).
- 0** Off.
- ↓** Single wipe (press down and release).

or

AUTO ↓ Automatic, then single wipe (see the corresponding section).

Rear wiper

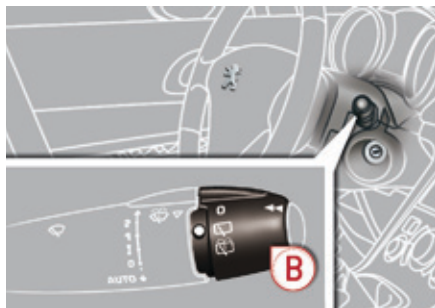

B. Rear wiper selection ring:



Park.



Intermittent wipe.



Wash-wipe (set duration).

Reverse gear

When reverse gear is engaged, the rear wiper will come into operation if the windscreen wipers are operating.

! If a significant accumulation of snow or ice is present, or when using a bicycle carrier on the boot, deactivate the automatic rear wiper via the multifunction screen configuration menu.

Programming



The function is activated or deactivated via the vehicle configuration menu. This function is activated by default.



Windscreen wash

Pull the wiper stalk towards you. The windscreen wash then the wipers operate for a set time.

The headlamp wash is also activated **if the dipped beam headlamps are on.**

Headlamp wash

Press the end of the lighting stalk to activate the headlamp wash, when the dipped beam headlamps are on.

i To reduce the consumption of screenwash fluid, the headlamp washers only operate with the first operation of the screenwash.

Screenwash/headlamp wash low level



In the case of vehicles fitted with headlamp washers, when the minimum level of the reservoir is reached, this warning lamp is displayed in the instrument panel, accompanied by an audible signal and a message. The warning lamp is displayed when the ignition is switched on, or every time the stalk is operated, until the reservoir is refilled. Next time you stop, refill the screenwash / headlamp wash reservoir.

4

Automatic rain sensitive windscreen wipers

The windscreen wipers operate automatically, without any action on the part of the driver, if rain is detected (sensor behind the rear view mirror), adapting their speed to the intensity of the rainfall.

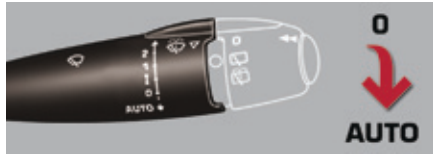

Activation

This is controlled manually by the driver by pushing the stalk downwards to the "AUTO" position. It is accompanied by a message in the screen.

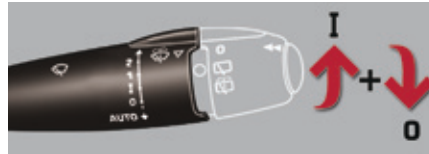

Switching off

This is controlled manually by the driver by moving the stalk upwards then returning it to position "0". It is accompanied by a message in the screen.

i The automatic rain sensitive wipers must be reactivated if the ignition has been off for more than one minute, by pushing the stalk downwards.

Operating fault

If an automatic wiping malfunction occurs, the wipers will operate in intermittent mode. Have it checked by a PEUGEOT dealer or a qualified workshop. Do not cover the rain sensor, linked with the

! sunshine sensor and located in the centre of the windscreen behind the rear view mirror. Switch off the automatic rain sensitive wipers when using an automatic car wash. In winter, to avoid damaging the wiper blades, it is advisable to wait until the windscreen is completely clear of ice before activating the automatic rain sensitive wipers.

Special position of the windscreen wipers



This position permits release of the windscreen wiper blades.

It is used for cleaning or replacement of the blades. It can also be useful, in winter, to detach the blades from the windscreen.

- ☞ Any action on the wiper stalk in the minute after switching off the ignition places the blades vertically on the screen.
- ☞ To park the blades again, switch on the ignition and operate the wiper stalk.

- i** To maintain the effectiveness of the flat wiper blades, it is advisable to:
- handle them with care,
 - clean them regularly using soapy water,
 - avoid using them to retain cardboard on the windscreen,
 - replace them at the first signs of wear.

Courtesy lamps

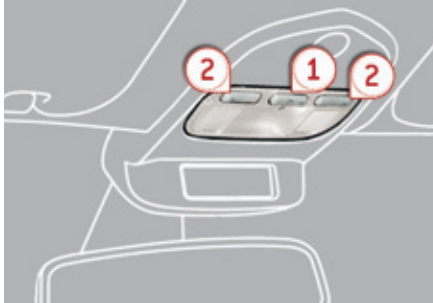

1. Front courtesy lamp
2. Map reading lamps



3. Rear courtesy lamp

Front and rear courtesy lamps



In this position, the courtesy lamp comes on gradually:

- when the vehicle is unlocked,
- when the key is removed from the ignition,
- when a door is opened,
- when the remote control locking button is activated, in order to locate your vehicle.

It switches off gradually:

- when the vehicle is locked,
- when the ignition is switched on,
- 30 seconds after the last door is closed.



Permanently off.



Permanent lighting.



With the "permanent lighting" mode, the lighting time varies according to the circumstances:

- with the ignition off, approximately ten minutes,
- in energy economy mode, approximately thirty seconds,
- with the engine running, unlimited.

Map reading lamps

- ☞ With the ignition on, press the corresponding switch.



Take care not to place anything in contact with the courtesy lamps.

Door mirror spotlamps

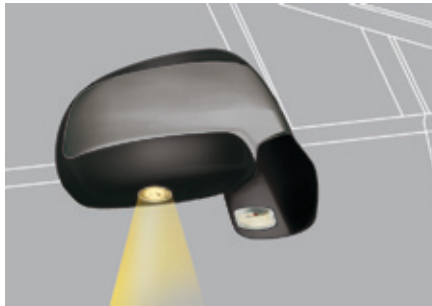

To make your approach to the vehicle easier, these illuminate:

- the zones facing the driver's and passenger's doors,
- the zones forward of the door mirrors and rearward of the front doors.

Switching on

The spotlamps come on:

- when you unlock the vehicle,
- when you remove the key from the ignition,
- when you open a door,
- when you use the remote control.

Switching off

They are timed to go off automatically.

Interior welcome lighting

The remote switching on of the passenger compartment lighting makes your approach to the vehicle easier in poor light. It operates with the automatic illumination of headlamps.

Switching on

- ☞ Press the open padlock on the remote control.

The courtesy lamps come on; your vehicle is also unlocked.

Switching off

The interior welcome lighting switches off automatically after a set time or when one of the doors is opened.

Programming



The function is activated or deactivated via the vehicle configuration menu.

i The duration of the welcome lighting is associated with and identical to that of the automatic guide-me-home lighting.

Interior mood lighting

The dimmed passenger compartment lighting improves visibility in the vehicle when the light is poor.



Switching on

At night, the mood lamp in the front courtesy lamp comes on automatically when the sidelamps are switched on.

Switching off

The interior mood lighting switches off automatically when the sidelamps are switched off.

Footwell lighting

The soft lighting provided by the footwell lamps improves visibility in the vehicle when the light is poor.

Activation



Its operation is identical to that of the courtesy lamps. The lamps come on when one of the doors is opened.

Boot lamp

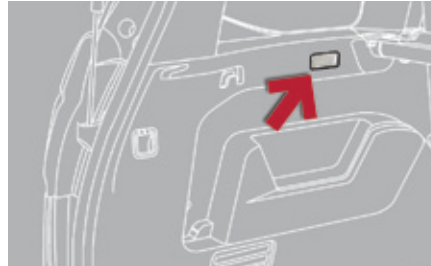

This comes on automatically when the boot is opened and switches off automatically when the boot is closed.

- i** Different lighting times are available:
 - when the ignition is off, approximately ten minutes,
 - in energy economy mode, approximately thirty seconds,
 - when the engine is running, no limit.

Torch



Portable lamp, fitted in the boot wall, which can be used to light the boot or as a torch.

- i** For the torch function, refer to the "Fittings" section.

Operation

Once engaged firmly in its location, it comes on automatically when the boot is opened and switches off automatically when the boot is closed. It operates with NiMH type rechargeable batteries. It has a battery life of approximately 45 minutes and recharges while you are driving.

- i** Observe the polarities when fitting the rechargeable batteries. Never replace the rechargeable batteries with normal single-use batteries.

Interior fittings

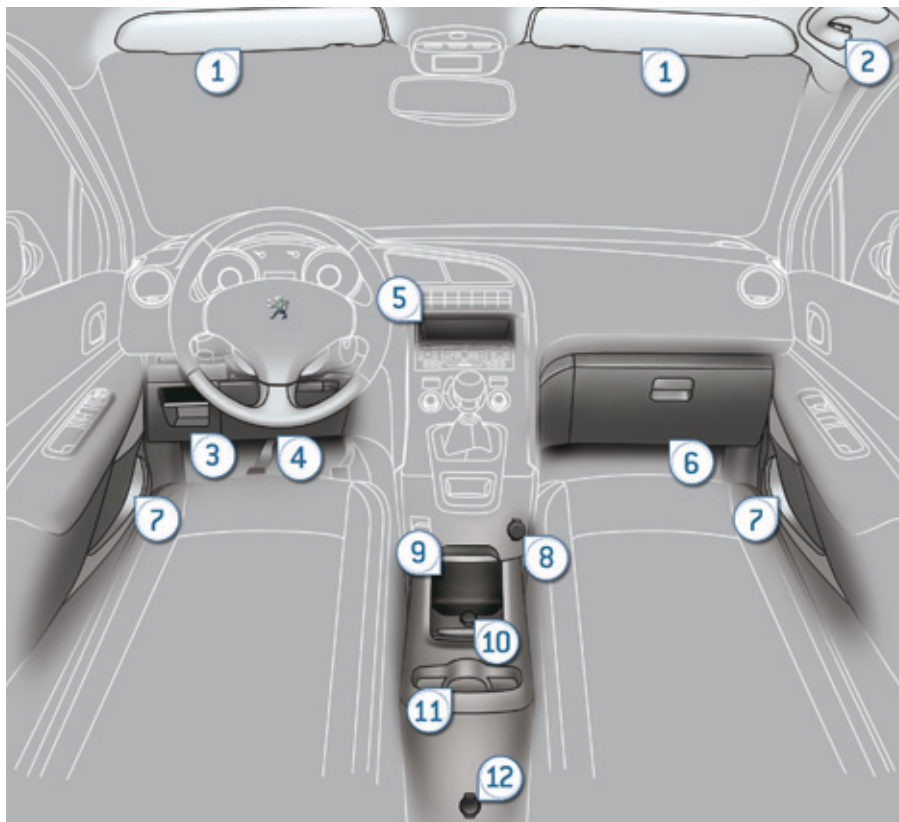

1. Sun visor
2. Grab handle with coat hook
3. Storage compartment
4. Storage compartment under the steering wheel
5. Storage compartment
6. Illuminated glove box
7. Door pockets
8. Front 12 V accessory socket (120 W)
9. Storage compartment
10. PEUGEOT Connect USB
11. Cup holder
12. Rear 12 V accessory socket (120 W)

Sun visor

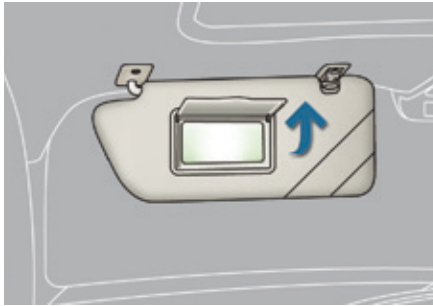

Component which protects against sunlight from the front or the side, also equipped with an illuminated courtesy mirror.

☞ With the ignition on, raise the concealing flap; the mirror is lit automatically.

This sun visor is also equipped with a ticket holder.

Driver's storage compartments

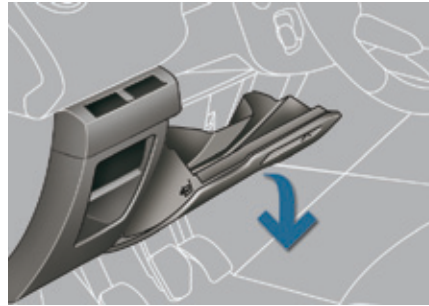

Storage box

This has storage areas for the handbook pack, ...

☞ To open, pull the handle then tilt the box.

Card holder

This can be used for a toll payment ticket or parking card, for example.

Coin storage

Storage

Illuminated glove box

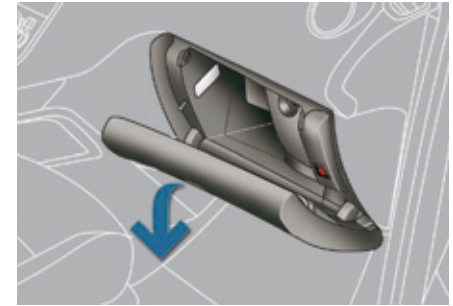

This has storage areas, audio sockets for a portable player and a location for the SIM card (only with PEUGEOT Connect Media Navigation (NG4 3D)), ...

☞ To open the glove box, raise the handle. The lamp comes on when the lid is opened.

i To connect a portable player or a SIM card, refer to the "Audio equipment and telematics" section.

Centre console

Storage device for the driver and front passenger.

Storage

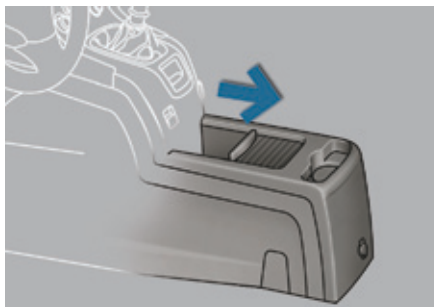

☞ Slide the cover for access to the 10.5 litre storage compartment.

This can contain 2 half-litre bottles.

A ventilation outlet distributes cooled air.

PEUGEOT Connect USB



This connection unit consists of a JACK auxiliary socket and/or a USB port.

It permits the connection of a portable device, such as a digital audio player of the iPod® type or a USB memory stick.

It reads the audio file formats (mp3, ogg, wma, wav...) which are transmitted to your audio system and played via the vehicle's speakers. You can manage these files using the steering mounted controls or the audio system control panel and display them in the multifunction screen.

Connected to the USB port, the portable device charges automatically.

While charging, a message is displayed if the current consumption by the portable device exceeds the amperage delivered by the vehicle.

i For more information on the use of this equipment, refer to the "Audio equipment and telematics" section.

12 V accessory sockets

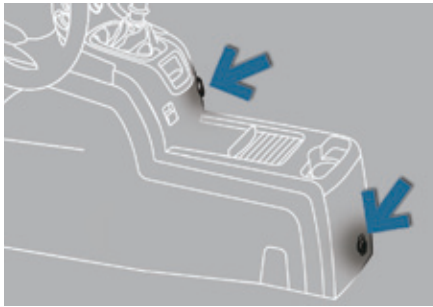

- ☞ To connect a 12 V accessory (max power: 120 Watts), remove the cover and connect a suitable adaptor.

Exceeding the maximum power could result in damage to your accessory.

Mats

Removable carpet protection.

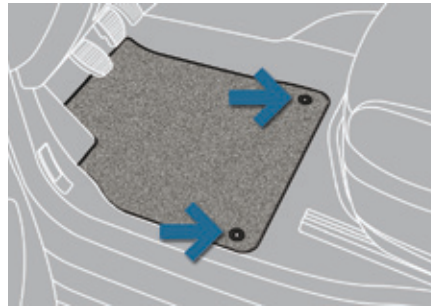

Fitting

When fitting the mat for the first time, on the driver's side use only the fixings provided in the wallet attached.

The other mats are simply placed on the carpet.

Removal

To remove the mat on the driver's side:

- ☞ move the seat as far back as possible,
- ☞ unclip the fixings,
- ☞ remove the mat.

Refitting

To refit the mat on the driver's side:

- ☞ position the mat correctly,
- ☞ refit the fixings by pressing,
- ☞ check that the mat is secured correctly.

! To avoid any risk of jamming of the pedals:

- only use mats which are suited to the fixings already present in the vehicle; these fixings must be used,
- never fit one mat on top of another.

The use of mats not approved by PEUGEOT may interfere with access to the pedals and hinder the operation of the cruise control / speed limiter.

The mats approved by PEUGEOT have two fixings located below the seat.

"Aircraft" type tables

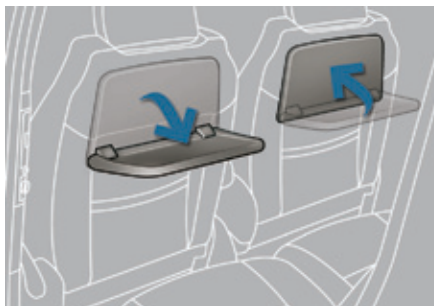

Installed on the back of each front seat, these allow you to set down objects.

- ☞ To use the table, lower it fully until it locks in the low position.
- ☞ To store the table, raise it, passing the point of resistance, to the high position.

! On the passenger side, do not forget to fold the "aircraft" type table before placing the seat in the table position. Do not place hard or heavy objects on the table. They could become dangerous projectiles in the event of emergency braking or impact.

Storage compartments under the rear footwells

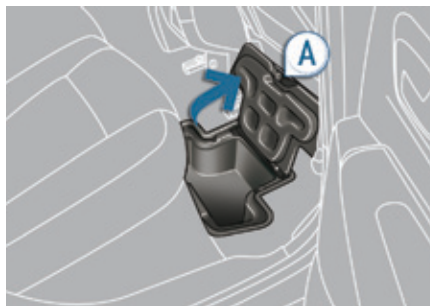

Depending on the configuration, the vehicle has storage compartments under the footwells, located forward of the outer rear seats. Access is via clipped flaps with a handle **A**.

Storage drawer

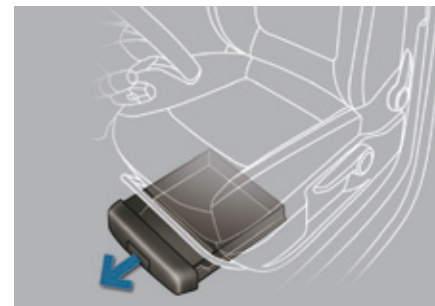

It is located under the driver's seat (manual adjustment).

Opening

- ☞ Raise the front of the drawer and pull it. Do not place heavy objects in the drawers.

5

Rear multimedia



This multimedia system allows rear passengers to connect one or two external portable systems (audio or video player, games consoles, DVD player...). The sound is played through two Bluetooth® wireless headphone sets, while the video content is displayed in two 7-inch screens built into the backs of the front seat head restraints.

i This system operates only with the engine running.

Description

The pack includes:

- the connection and control panel fitted on the rear face of the centre console,
- two 7-inch screens built into the front head restraints (with protective covers),
- two wireless Bluetooth technology headphone sets with rechargeable batteries,
- a 12 V charger with two outlets allowing the simultaneous charging of two headphones.

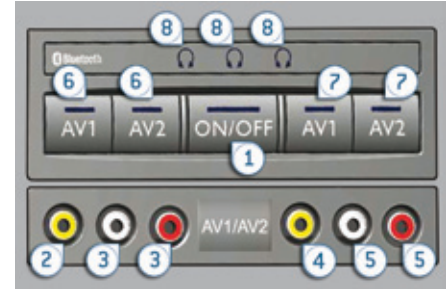

1. Power switch
2. AV1 video input (yellow RCA socket)
3. Stereo audio input A (red and white RCA sockets)
4. AV2 video input (yellow RCA socket)
5. Stereo audio input B (red and white RCA sockets)
6. Selection of display in the left hand screen (AV1 or AV2)
7. Selection of display in the right hand screen (AV1 or AV2)
8. Connection indicator lamps for the Bluetooth audio headphones (blue)

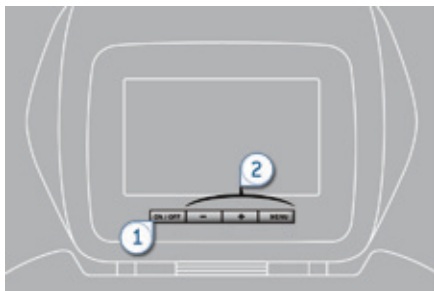

1. Screen power switch
2. Display adjustment buttons



Each headphone set has a switch, a connection indicator lamp (blue) and a channel selector (A or B).

Operation



- ☞ With the engine running, connect your portable system to the RCA connectors (e.g. with AV1 on the left).
- ☞ Press the switch on the control panel, the indicator lamp comes on and the AV1 indicator lamps come on.
- ☞ Make a long press on the switch, its indicator lamp flashes in blue.
- ☞ Make a long press on the control panel switch, the pairing with the headphone set is complete when the blue indicator lamps on the headphones and on the system are on continuously.
- ☞ Repeat the operation for the other headphone set.
- ☞ Press the screen switch if you have a video source.
- ☞ Start playing your portable system.

- ☞ It is possible at any time to modify the source for the video display (using button **6** or **7** on the control panel: the indicator lamp for the source selected comes on) as well as the audio channel (using the selector on the headphones).

! The Multimedia system allows the connection of a third Bluetooth headphone set, not supplied.

5

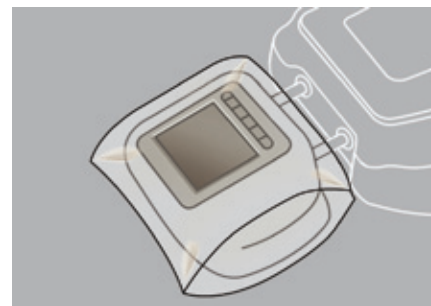

i If your seat is in the table position, position a cover to avoid damaging the screen. These covers also conceal each screen.

Panoramic sunroof

It has a blind that can be used to improve temperature and noise related comfort in the passenger compartment.

Motorised blind

Depending on version, the blind is opened and closed using:

- button **A** on the centre console,
- or button **B** on the dashboard.

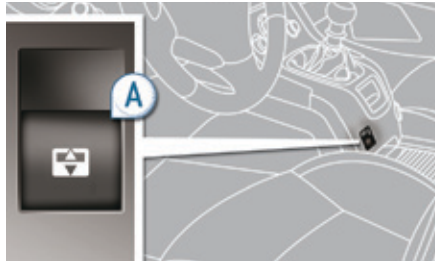

With button **A**:

- pull the control to open the blind,
- push the control to close the blind.

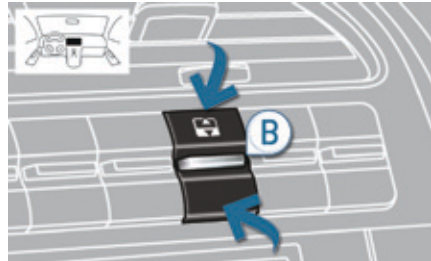

With button **B**:

- press at the top to open the blind,
- press at the bottom to close the blind.

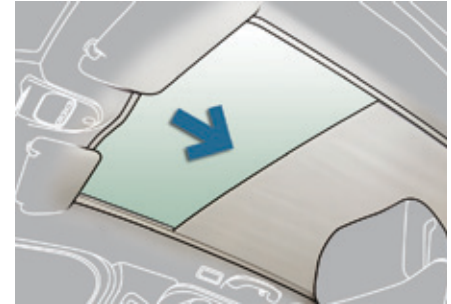

Manual mode

Maintaining pressure on the control opens or closes the blind: movement stops if you release the control. Pressure on the control in the opposite direction reverses the movement.

i The control is operational with the ignition on and for 45 seconds after switching off the ignition.

Automatic mode

Pressing and releasing the control opens or closes the blind completely. Pressing again stops the movement.

Safety anti-pinch

In automatic mode and at the end of its travel, if the blind meets an obstacle while closing it stops and moves back slightly.

Reinitialisation: after reconnecting the battery or in the event of a fault while the blind is moving, it may be necessary to reinitialise the system:

- ☞ Operate the control until the blind is fully closed or open.
- ☞ Continue to press for at least 3 seconds. A slight movement of the blind will then be noticeable, confirming the reinitialisation.

- ! If the blind opens on its own while closing, and immediately after it stops.
 - ☞ Operate the control until the blind is fully open.
 - ☞ Operate the control until the blind is fully closed.

The safety anti-pinch function is not operational during these operations.

- ! If the blind meets an obstacle during operation, you must reverse the movement of the blind. When the driver operates the blind control, they must ensure that nothing and no one is preventing the correct closing of the blind. The driver must ensure that passengers use the blind correctly. Be aware of children when operating the blind.

Boot fittings (5 seat version)

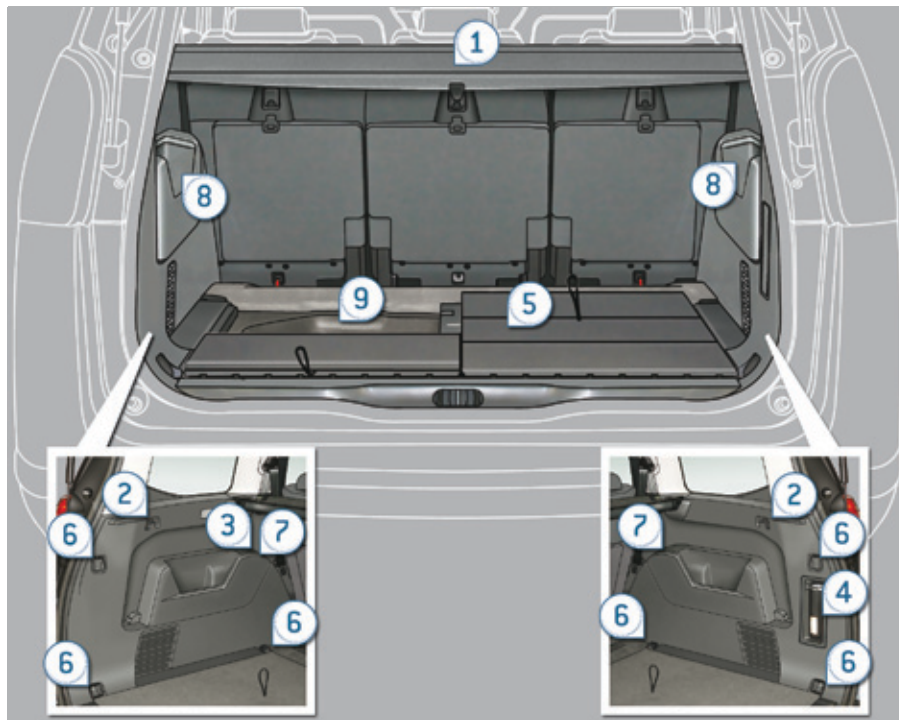

1. Load space cover
2. Hooks
3. 12 V accessory socket (120 W)
4. Torch
5. Concertina boards
6. Stowing rings on the floor
7. Cup holder
8. Storage compartments or audio amplifier
9. Storage compartment under the floor

Boot fittings (7 seat version)

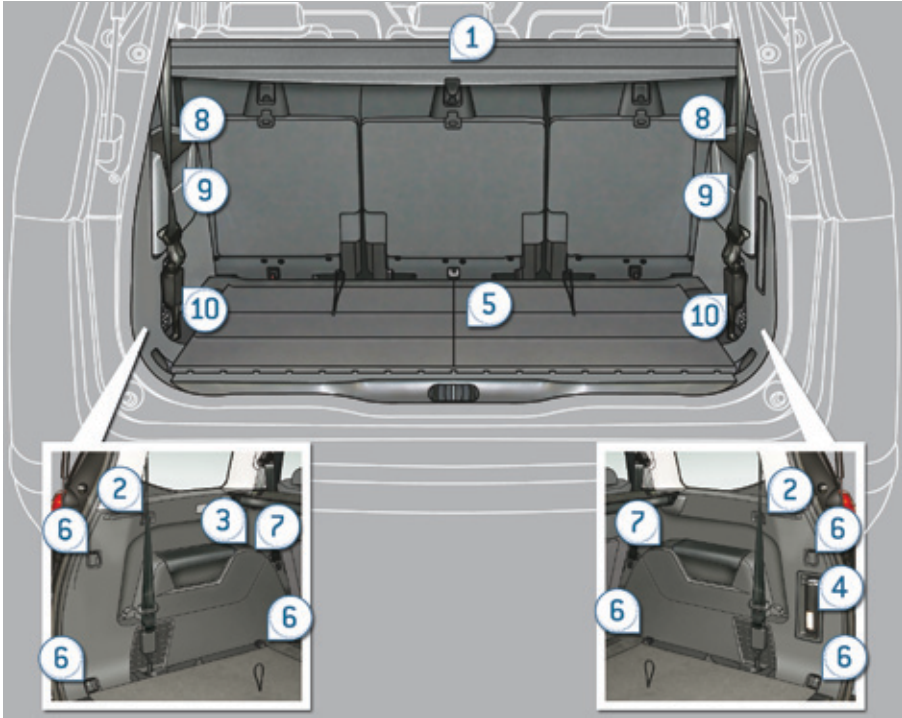

- 1. Load space cover
- 2. Hooks
- 3. 12 V accessory socket (120 W)
- 4. Torch
- 5. Concertina boards
- 6. Stowing rings on the floor
- 7. Cup holder
- 8. Armrests
- 9. Storage compartments or audio amplifier
- 10. 3rd row seat belt buckles

5

Roller load space cover

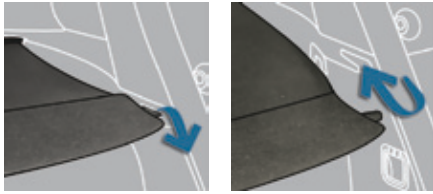

To remove the load space cover:

- ☞ remove the load space cover guides from the rails on the boot pillars,
- ☞ reel in the load space cover in its roller,



- ☞ pivot the ends of the roller upwards to release it,
- ☞ remove the roller from its support.

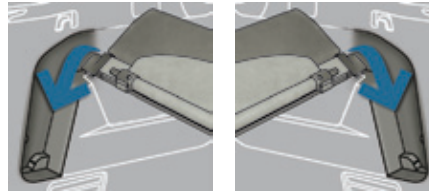

To store the load space cover, roller uppermost and flap facing towards the inside of the vehicle:

- ☞ place the right-hand end in its housing,
- ☞ slide the left-hand end into the guide then into its housing,

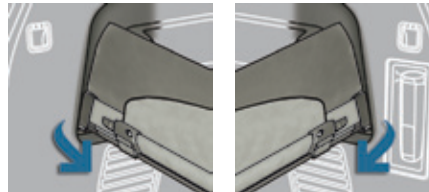

- ☞ secure the assembly by pivoting the ends downwards.



To install the load space cover:

- ☞ position one of the ends of the roller in its support,
- ☞ insert the second end in its support,
- ☞ pivot the ends of the roller downwards to secure it,
- ☞ reel out the load space cover to the boot pillars,
- ☞ insert the load space screen guides in the rails on the boot pillars.

! If you use the 3rd row seats (7 seat version), it is essential to store the roller in its housing.

i The roller has two rings for fixing the luggage retaining net depending on its location.

High load retaining net*

Hooked onto the special upper and lower fixings, this permits use of the entire loading volume up to the roof:

- behind the front seats (row 1) when the rear seats are folded.
- behind the rear seats (row 2).

i When positioning the net, check that the strap loops are visible from the boot; this will make slackening or tightening easier.

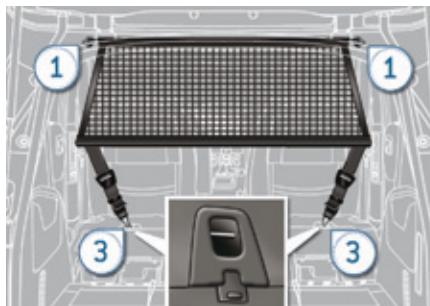
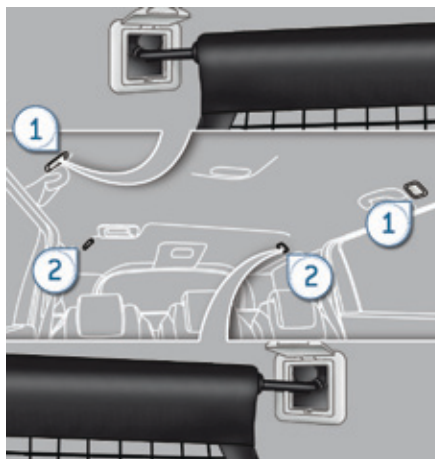

To use it in row 1:

- ☞ fold the rear seats,
- ☞ open the covers of the upper fixings 1,
- ☞ unroll the high load retaining net,
- ☞ position one of the ends of the net's metal bar in the corresponding upper fixing 1, then do the same with the other end,
- ☞ slacken the straps fully,
- ☞ fix the snap hook of each of the straps on the corresponding Top Tether ring 3 (located on the back of the folded rear side seats),
- ☞ tighten the straps,
- ☞ check that the net is hooked and tightened correctly.

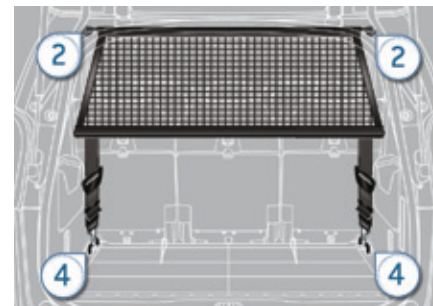

To use it in row 2:

- ☞ roll up or remove the load space screen,
- ☞ open the covers of the upper fixings 2,
- ☞ unroll the high load retaining net,
- ☞ position one of the ends of the net's metal bar in the corresponding upper fixing 2, then do the same with the other end,
- ☞ fix the snap hook of each of the straps in the corresponding stowing ring 4,
- ☞ tighten the straps,
- ☞ check that the net is hooked and tightened correctly.

* If your vehicle is equipped with this.

Luggage retaining net

Hooked onto the stowing rings on the floor and/or on the load space cover roller, the luggage retaining net available as an accessory enables you to secure your luggage.

There are 4 possible positions:

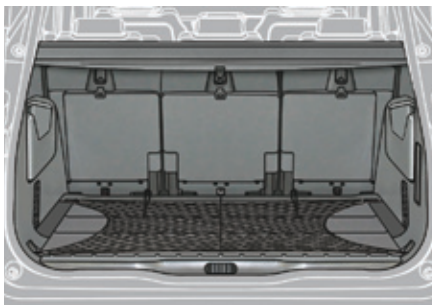

- flat at the bottom of the boot,



- vertical at the back of the rear seats,

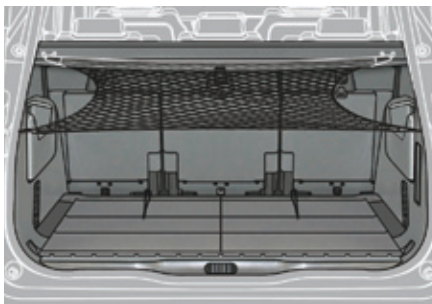

- horizontal, level with the load space cover,



- flat at the bottom of the boot and vertical at the back of the rear seats.

Hooks

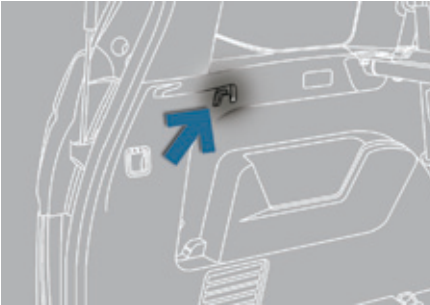

The hooks can be used to hold shopping bags.

12 V accessory socket



- ☞ To connect a 12 V accessory (max power: 120 W), remove the cap and connect an appropriate adaptor.
- ☞ Turn the key to the ignition on position.

Storage box (5 seat version)

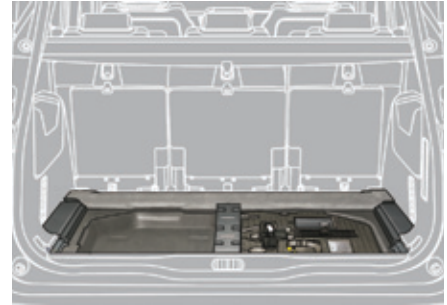

- ☞ Raise the concertina board to gain access to the storage box.
- Depending on the configuration, this has areas for storing:
- a box of spare bulbs,
 - a first aid kit,
 - a tyre repair kit,
 - two warning triangles,
 - ...

Torch

This is a removable lamp, fitted in the boot wall, which can be used to illuminate the boot or as a torch.

i For the boot lighting function, refer to the "Visibility" section.



Operation

This torch operates with NiMH type rechargeable batteries.

It has a battery life of approximately 45 minutes and charges while you are driving.

! Observe the polarities when fitting the batteries.
Never replace the rechargeable batteries with normal single-use batteries.

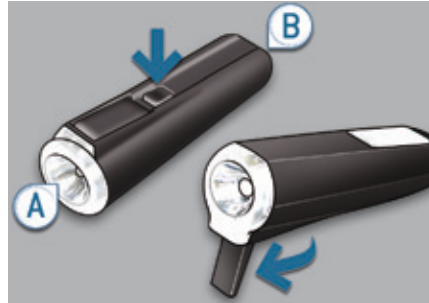

Use

- ☞ Extract the torch from its location pulling the side of the torch **A**.
- ☞ Press the switch, located on the back, to switch the torch on or off.
- ☞ Unfold the support, located on the back, to set down and raise the torch; for example, when changing a wheel.

Storing

- ☞ Put the torch back in place in its location starting with the narrow part **B**.
If you have forgotten to switch off the torch, this switches it off automatically.

i If the torch is not engaged correctly, it may not charge and may not come on when the boot is opened.

Rear side blinds

Fitted at the rear windows, these protect your young children from the sun.

☞ Pull the blind by the central tab.

2nd row



3rd row (7 seat version)

☞ Position the blind attachment on the hook.

Manual child lock

Mechanical system to prevent opening of the rear door using its interior control. The control is located on the edge of each rear door.

Locking

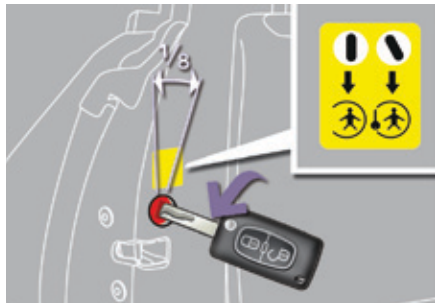

- ☞ Turn the red control one eighth of a turn using the ignition key as shown in the label on the door. **Check that the lock is on.**

Unlocking

- ☞ Turn the red control one eighth of a turn using the ignition key.

Electric child lock

Remote control system to prevent opening of the rear doors using their interior controls and use of the rear electric windows.

Switching on



- ☞ With the ignition on, press this button. The indicator lamp in the button comes on, accompanied by a message to confirm that the child lock is on. This indicator lamp remains on until the child lock is switched off. It is still possible to open the doors from the outside and operate the rear electric windows from the driver's control panel.

Switching off

- ☞ With the ignition on, press this button again. The indicator lamp in the button goes off, accompanied by a message to confirm that the child lock is off. This indicator lamp remains off while the child lock is switched off.

! Any other status of the indicator lamp indicates a fault with the electric child lock. Have it checked by a PEUGEOT dealer or a qualified workshop.

! This system is independent and in no circumstances does it take the place of the central locking control. Check the status of the child lock each time you switch on the ignition. Always remove the key from the ignition when leaving the vehicle, even for a short time. In the event of a serious impact, the electric child lock is switched off automatically to permit the exit of the rear passengers.

Direction indicators



- ☞ Lower the lighting control stalk fully when moving to the left.
- ☞ Raise the lighting control stalk fully when moving to the right.

i If you forget to cancel the direction indicators for more than twenty seconds, the volume of the audible signal will increase if the speed is above 40 mph (60 km/h).

Three flashes

Move the stalk briefly upwards or downwards, without going beyond the point of resistance; the corresponding direction indicators will flash 3 times.

This function can be used at any speed, but it is particularly useful for changing lane on fast roads.

Hazard warning lamps

A visual warning by means of the direction indicators to alert other road users to a vehicle breakdown, towing or accident.

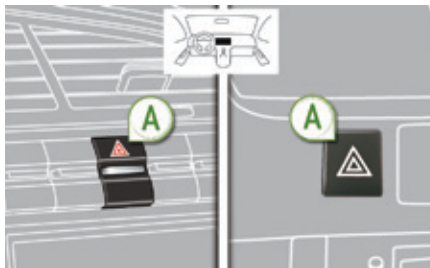

- ☞ Tilt or press button **A**, the direction indicators flash. They can operate with the ignition off.

Automatic operation of hazard warning lamps

When braking in an emergency, depending on the deceleration, the hazard warning lamps come on automatically.

They switch off automatically the first time you accelerate.

- ☞ You can also switch them off by pressing the button.

Horn

Audible warning to alert other road users to an imminent danger.



- ☞ Press one of the spokes of the steering wheel.

Electronic stability control (ESC)

Electronic Stability Control (ESC) incorporating the following systems:

- the anti-lock braking system (ABS) and the electronic brake force distribution (EBFD),
- the emergency braking assistance,
- the anti-slip regulation (ASR) or traction control,
- the dynamic stability control (DSC).

Definitions

Anti-lock braking system (ABS) and electronic brake force distribution (EBFD)

This system improves the stability and manoeuvrability of your vehicle when braking and provides improved control in corners, in particular on poor or slippery road surfaces. The ABS prevents wheel lock in the event of emergency braking.

The electronic brake force distribution system manages the braking pressure wheel by wheel.

Emergency braking assistance

In an emergency, this system enables you to reach the optimum braking pressure more quickly and therefore reduce the stopping distance.

It is triggered according to the speed at which the brake pedal is pressed. This is felt by a reduction in the resistance of the pedal and an increase in the effectiveness of the braking.

Anti-slip regulation (ASR)

The ASR system (also known as Traction Control) optimises traction in order to limit wheel slip by acting on the brakes of the driving wheels and on the engine. It also improves the directional stability of the vehicle on acceleration.

Dynamic stability control (DSC)

If there is a difference between the path followed by the vehicle and that required by the driver, the DSC monitors each wheel and automatically acts on the brake of one or more wheels and on the engine to return the vehicle to the required path, within the limits of the laws of physics.

Snow driving assistance (Intelligent Traction Control)

Your vehicle has a system to help driving on snow: **Intelligent Traction Control**.

This automatic system continuously checks for situations of difficult surface adhesion that could make it difficult to move off or make progress on deep fresh snow or compacted snow.

In these situations, **Intelligent Traction Control** limits the amount of wheel slip to provide the best traction and trajectory control.

In extremely severe conditions (deep snow, mud...), it can be useful to temporarily deactivate the **dynamic stability control and wheel anti-slip** systems to allow a degree of wheel spin and so recover grip.

It is recommended that the system be reactivated as soon as possible.

Snow tyres are strongly recommended on surfaces offering low levels of adhesion.

Operation

Anti-lock braking system (ABS) and electronic brake force distribution (EBFD)



When this warning lamp comes on, accompanied by an audible signal and a message, it indicates that there is a fault with the ABS, which could cause loss of control of the vehicle when braking.



When this warning lamp comes on, coupled with the **STOP** warning lamp, accompanied by an audible signal and a message, it indicates that there is a fault with the electronic brake force distribution (EBFD), which could cause loss of control of the vehicle when braking.

You must stop as soon as it is safe to do so. In both cases, contact a PEUGEOT dealer or a qualified workshop.



When changing wheels (tyres and rims), make sure that these are approved for your vehicle.



Normal operation of the ABS may make itself felt by slight vibrations of the brake pedal.

In emergency braking, press very firmly without releasing the pressure.

Dynamic stability control (DSC) and anti-slip regulation (ASR)

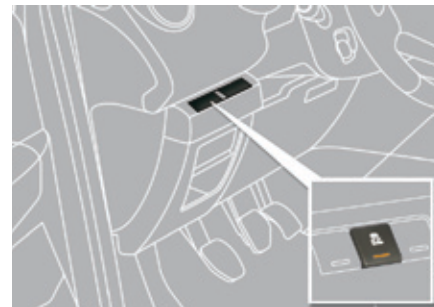

7

Activation

These systems are activated automatically each time the vehicle is started. As soon as they detect a problem of grip or trajectory, these systems act on the operation of the engine and brakes.



This is indicated by flashing of this warning lamp in the instrument panel.

Deactivation

In exceptional conditions (starting a vehicle which is bogged down, stuck in snow, on soft ground...), it may be advisable to deactivate the DSC and ASR, so that the wheels can turn freely and regain grip.

Reactivate the systems as soon as the level of grip permits.



☞ Press this button.

The indicator lamp in the button comes on. The DSC and ASR systems no longer act on the operation of the engine and on the brakes in the event of a involuntary change of trajectory.

Reactivation

The systems are reactivated automatically each time the ignition is switched back on or from 30 mph (50 km/h).

Below 30 mph (50 km/h), you can reactivate them manually:

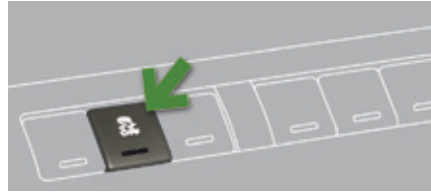

☞ Press this button again.

Operating fault



Illumination of this warning lamp and the lamp in the deactivation button, accompanied by an audible signal and a message, indicate a fault with the system.

Contact a PEUGEOT dealer or a qualified workshop to have the system checked.

i DSC/ASR

The DSC and ASR systems offer increased safety in normal driving, but they should not encourage the driver to take extra risks or drive at high speed. It is in conditions of reduced grip (rain, snow, ice) that the risk of loss of grip increases. It is therefore important for your safety to keep the DSC and ASR systems activated in all conditions, and particularly in difficult conditions.

The correct operation of these systems depends on observation of the manufacturer's recommendations regarding as much the wheels (tyres and rims), braking and electronic components as the assembly and repair procedures used by PEUGEOT dealers. To benefit in full from the effectiveness of the DSC and ASR systems in wintry conditions, the vehicle must be fitted with four snow tyres, allowing the vehicle to retain neutral behaviour on the road.

i After an impact, have these systems checked by a PEUGEOT dealer or a qualified workshop.

Seat belts

Front seat belts



The front seat belts are fitted with a pretensioning and force limiting system. This system improves safety in the front seats in the event of a front or side impact. Depending on the severity of the impact, the pretensioning system instantly tightens the seat belts against the body of the occupants. The pretensioning seat belts are active when the ignition is on. The force limiter reduces the pressure of the seat belt on the chest of the occupant, so improving their protection.



Fastening

- ☞ Pull the strap, then insert the tongue in the buckle.
- ☞ Check that the seat belt is fastened correctly by pulling the strap.

Unfastening

- ☞ Press the red button on the buckle.
- ☞ Guide the seat belt as it reels in.

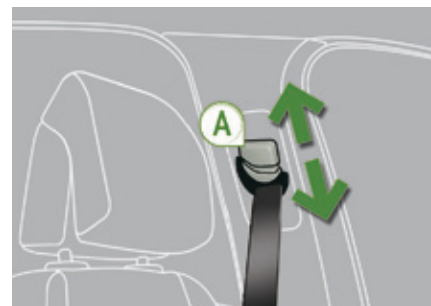

Height adjustment

- ☞ To adjust the anchorage point, squeeze the control **A** and slide it until you find a notch.

Front seat belts not fastened / unfastened warning lamp



When the ignition is switched on, this warning lamp comes on in the seat belt and passenger's front airbag warning lamps display, if the driver and/or the front passenger has not fastened their seat belt. From approximately 12 mph (20 km/h) this warning lamp flashes for two minutes accompanied by an audible signal. Once these two minutes have elapsed, this warning lamp remains on until the driver and/or the front passenger fastens their seat belt.

Seat belts not fastened / unfastened warning lamps display

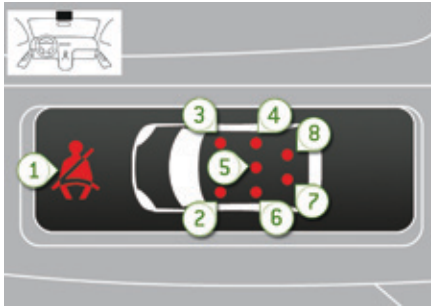

1. Front and/or rear seat belts not fastened / unfastened warning lamp.
2. Front left seat belt warning lamp.
3. Front right seat belt warning lamp.
4. Rear right seat belt warning lamp.
5. Rear centre seat belt warning lamp.
6. Rear left seat belt warning lamp.

The corresponding warning lamp **2** or **3** comes on in red on the seat belt and passenger's front airbag warning lamps display if the seat belt is not fastened or is unfastened.

7 seat version

7. 3rd row rear left seat belt warning lamp
8. 3rd row rear right seat belt warning lamp.

Rear seat belts

The rear seats are each fitted with a three-point inertia reel seat belt with force limiter (with the exception of the centre rear seat).

Fastening

- ☞ Pull the strap, then insert the tongue in the buckle.
- ☞ Check that the seat belt is fastened correctly by pulling the strap.

Unfastening

- ☞ Press the red button on the buckle.
- ☞ Guide the seat belt as it reels in.

Seat belt unfastened warning lamp



This warning lamp comes on in the seat belt and passenger's front airbag warning lamps display, when one or more rear passengers unfasten their seat belt.

From approximately 12 mph (20 km/h), this warning lamp flashes for two minutes accompanied by an audible signal. Once these two minutes have elapsed, this warning lamp remains on until the one or more rear passengers fasten their seat belt.

Seat belt unfastened warning lamps display

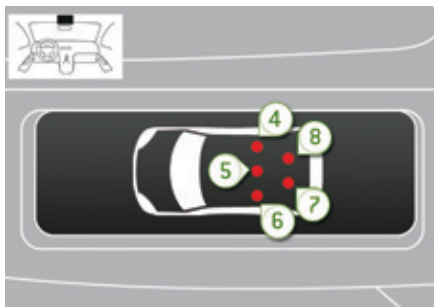

When the ignition is switched on, with the engine running or when the vehicle is moving at less than 12 mph (20 km/h), the corresponding warning lamps 4 to 8 come on in red for approximately 30 seconds, if the seat belt is not fastened. When the vehicle is moving at more than 12 mph (20 km/h), the corresponding warning lamp 4, 5, 6, 7 or 8 comes on in red, accompanied by an audible signal and a message in the multifunction screen, if a rear passenger has unfastened their seat belt.

i To prevent movement of the rear side seat belts in the 2nd row, slide the straps into the guides provided for this purpose.

2nd row rear centre seat belt

The seat belt for the rear centre seat of the 2nd row is incorporated at the rear right of the roof.



Installation

- ☞ Pull the strap and insert the tongue **A** in the right-hand buckle.
- ☞ Insert the tongue **B** in the left-hand buckle.
- ☞ Check the fastening of each buckle by pulling the strap.

Removal and storing

- ☞ Press the red button on the buckle **B**, then on the buckle **A**.
- ☞ Guide the strap as it reels in and bring the tongue **B**, then **A** onto the magnet of the attachment point on the roof.

3rd row rear seat belts (7 seat version)

The seat belts for the rear seats of the 3rd row are incorporated at the corner of the corresponding boot pillar and of the roof.



Installation

- ☞ Pull the strap and insert the tongue **C** in the buckle, on the boot side trim side.
- ☞ Insert the tongue **D** in the opposite buckle.
- ☞ Check the fastening of each buckle by pulling the strap.

Removal and storing

- ☞ Press the red button on the buckle **D**, then on the buckle **C**.
- ☞ Guide the strap as it reels in and the tongues **D** and **C**.

I The driver must ensure that passengers use the seat belts correctly and that they are all restrained securely before setting off. Wherever you are seated in the vehicle, always fasten your seat belt, even for short journeys.

Do not interchange the seat belt buckles as they will not fulfil their role fully.

The seat belts are fitted with an inertia reel permitting automatic adjustment of the length of the strap to your size. The seat belt is stowed automatically when not in use.

Before and after use, ensure that the seat belt is reeled in correctly.

The lower part of the strap must be positioned as low as possible on the pelvis.

The upper part must be positioned in the hollow of the shoulder.

The inertia reels are fitted with an automatic locking device which comes into operation in the event of a collision, emergency braking or if the vehicle rolls over. You can release the device by pulling the strap firmly and then releasing it so that it reels in slightly.

In order to be effective, a seat belt must:

- be tightened as close to the body as possible,
- be pulled in front of you with a smooth movement, checking that it does not twist,
- be used to restrain only one person,
- not bear any trace of cuts or fraying,
- not be converted or modified to avoid affecting its performance.

In accordance with current safety regulations, for all repairs on your vehicle's seat belts, go to a qualified workshop with the skills and equipment needed, which a PEUGEOT dealer is able to provide.

Have your seat belts checked regularly by a PEUGEOT dealer or a qualified workshop, particularly if the straps show signs of damage.

Clean the seat belt straps with soapy water or a textile cleaning product, sold by PEUGEOT dealers.

After folding or moving a seat or rear bench seat, ensure that the seat belt is positioned and reeled in correctly.

Recommendations for children

Use a suitable child seat if the passenger is less than 12 years old or shorter than one and a half metres.

Never use the same seat belt to secure more than one person.

Never allow a child to travel on your lap.

For more information, refer to the "Child seats" section.

In the event of an impact

Depending on the nature and seriousness of the impact, the pretensioning device may be deployed before and independently of the airbags. Deployment of the pretensioners is accompanied by a slight discharge of harmless smoke and a noise, due to the activation of the pyrotechnic cartridge incorporated in the system.

In all cases, the airbag warning lamp comes on. Following an impact, have the seat belts system checked, and if necessary replaced, by a PEUGEOT dealer or a qualified workshop.

Airbags

System designed to maximise the safety of the occupants (with the exception of the rear centre passenger) in the event of violent collisions.

The airbags supplement the action of the force-limiting seat belts (with the exception of the centre rear passenger).

If a collision occurs, the electronic detectors record and analyse the front and side impacts sustained in the impact detection zones:

- in the case of a serious impact, the airbags are deployed instantly and contribute towards better protection of the occupants of the vehicle (with the exception of the rear centre passenger); immediately after the impact, the airbags deflate rapidly so that they do not hinder visibility or the exit of the occupants,
- in the case of a minor or rear impact or in certain roll-over conditions, the airbags will not be deployed; the seat belt alone contributes towards ensuring your protection in these situations.

! **The airbags do not operate when the ignition is switched off.**

This equipment will only deploy once. If a second impact occurs (during the same or a subsequent accident), the airbag will not be deployed again.

Impact detection zones

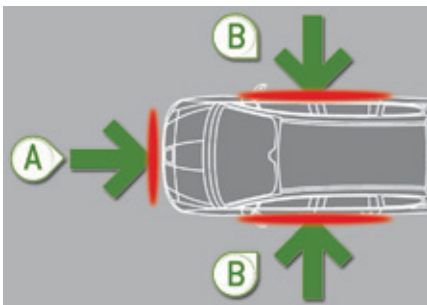

- A. Front impact zone.
B. Side impact zone.

i Deployment of the airbag(s) is accompanied by a slight emission of smoke and a noise, due to the activation of the pyrotechnic cartridge incorporated in the system. This smoke is not harmful, but sensitive individuals may experience slight irritation. The noise of the detonation may result in a slight loss of hearing for a short time.

Front airbags

System which protects the driver and front passenger in the event of a serious front impact in order to limit the risk of injury to the head and thorax.

The driver's airbag is fitted in the centre of the steering wheel; the front passenger's airbag is fitted in the dashboard above the glove box.



Deployment

The airbags are deployed, except the passenger's front airbag if it is deactivated, in the event of a serious front impact to all or part of the front impact zone **A**, in the longitudinal centreline of the vehicle on a horizontal plane and directed from the front to the rear of the vehicle.

The front airbag inflates between the thorax and head of the front occupant of the vehicle and the steering wheel, driver's side, and the dashboard, passenger's side to cushion their forward movement.

Deactivation

Only the passenger's front airbag can be deactivated.

- ☞ **With the ignition off**, insert the key in the passenger airbag deactivation switch.
- ☞ Turn it to the **"OFF"** position.
- ☞ Then, remove the key keeping the switch in the new position.



On switching on the ignition, this warning lamp comes on in the instrument panel and/or in the seat belt and passenger's front airbag warning lamps display. It stays on until the airbag is reactivated.



To assure the safety of your child, the passenger's front airbag must be deactivated when you install a "rear facing" child seat on the front passenger seat. Otherwise, the child would risk being seriously injured or killed if the airbag were deployed.

Reactivation

When you remove the "rearward facing" child seat, **with the ignition off**, turn the switch to the **"ON"** position to reactivate the airbag and so assure the safety of your front passenger in the event of an impact.



When switching the ignition on, this warning lamp comes on in the seat belt and passenger's front airbag warning lamps display for approximately one minute, to signal that the passenger's front airbag is activated.

Operating fault



If this warning lamp comes on, accompanied by an audible warning and a message, contact a PEUGEOT dealer or a qualified workshop without delay to have the system checked. The airbags may no longer be deployed in the event of a serious impact.

Lateral airbags

System which protects the driver and front passenger in the event of a serious side impact in order to limit the risk of injury to the chest. Each lateral airbag is fitted in the front, in the outer side of the seat back frame.



Deployment

The lateral airbags are deployed unilaterally in the event of a serious side impact applied to all or part of the side impact zone **B**, perpendicular to the longitudinal centreline of the vehicle on a horizontal plane and directed from the outside towards the inside of the vehicle.

The lateral airbag inflates between the front occupant of the vehicle and the corresponding door panel.

Impact detection zones

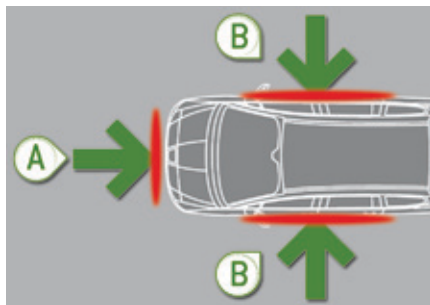

- A. Front impact zone.
- B. Side impact zone.

Curtain airbags

System which contributes towards improving the protection of the driver and passengers (with the exception of the rear centre passenger) in the event of a serious side impact in order to limit the risk of injury to the side of the head.

Each curtain airbag is built into the pillars and the upper passenger compartment area.

Deployment

The curtain airbag is deployed at the same time as the corresponding lateral airbag in the event of a serious side impact applied to all or part of the side impact zone **B**, perpendicular to the longitudinal centreline of the vehicle on a horizontal plane and directed from the outside towards the inside of the vehicle.

The curtain airbag inflates between the front or rear occupant of the vehicle and the windows.

Operating fault



If this warning lamp comes on in the instrument panel, accompanied by an audible signal and a message in the screen, contact a PEUGEOT dealer or a qualified workshop to have the system checked. The airbags may no longer be deployed in the event of a serious impact.



In the event of a minor impact or bump on the side of the vehicle or if the vehicle rolls over, the airbag may not be deployed.
In the event of a rear or front collision, the airbag is not deployed.

! **For the airbags to be fully effective, observe the following safety rules:**

Sit in a normal upright position.

Wear a correctly adjusted seat belt.

Do not leave anything between the occupants and the airbags (a child, pet, object...). This could hamper the operation of the airbags or injure the occupants.

After an accident or if the vehicle has been stolen or broken into, have the airbag systems checked.

All work on the airbag system must be carried out by a PEUGEOT dealer or a qualified workshop.

Even if all of the precautions mentioned are observed, a risk of injury or of minor burns to the head, chest or arms when an airbag is deployed cannot be ruled out. The bag inflates almost instantly (within a few milliseconds) then deflates within the same time discharging the hot gas via openings provided for this purpose.

Front airbags

Do not drive holding the steering wheel by its spokes or resting your hands on the centre part of the wheel.

Passengers must not place their feet on the dashboard.

Do not smoke as deployment of the airbags can cause burns or the risk of injury from a cigarette or pipe.

Never remove or pierce the steering wheel or hit it violently.

Do not fit or attach anything to the steering wheel or dashboard, this could cause injuries with deployment of the airbags.

Lateral airbags

Use only approved covers on the seats, compatible with the deployment the lateral airbags. For information on the range of seat covers suitable for your vehicle, you can contact a PEUGEOT dealer.

Refer to the "Accessories" section.

Do not fix or attach anything to the seat backs (clothing...). This could cause injury to the chest or arms if the lateral airbag is deployed.

Do not sit with the upper part of the body any nearer to the door than necessary.

Curtain airbags

Do not fix or attach anything to the roof. This could cause injury to the head if the curtain airbag is deployed.

If fitted on your vehicle, do not remove the grab handles installed on the roof, they play a part in securing the curtain airbags.

Starting-switching off the engine

Anti-theft protection

Electronic engine immobiliser

The key contains an electronic chip which has a special code. When the ignition is switched on, this code must be recognised for engine starting to be authorised.

This electronic engine immobiliser locks the engine management system a few minutes after the ignition is switched off and prevents starting of the engine by anyone who does not have the key.

! In the event of a fault, you are informed by illumination of this warning lamp, an audible signal and a message in the screen.

In this case, your vehicle will not start; contact a PEUGEOT dealer as soon as possible.

i Keep safely, away from your vehicle, the label attached to the keys given to you on acquisition of the vehicle.

Ignition switch

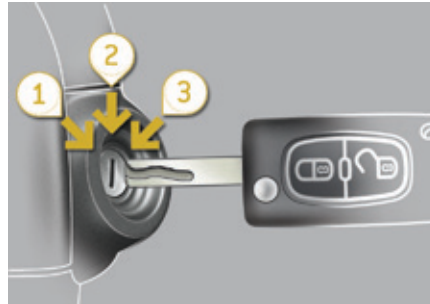

It has 3 positions:

- position **1 (Stop)**: insert and removing the key.
- position **2 (Ignition on)**: steering column unlocked, ignition on, Diesel preheating, engine running
- position **3 (Starting)**.

Ignition on position

It allows the use of the vehicle's electric equipment or portable devices to be charged. Once the state of charge of the battery drops to the reserve level, the system switches to energy economy mode: the power supply is cut off automatically to preserve the remaining battery charge.

Starting the engine

With the parking brake applied and the gearbox in neutral or position **N** or **P**:

- ☞ depress the clutch pedal fully (manual gearbox),
or
- ☞ press the brake pedal firmly (electronic or automatic gearbox),
- ☞ insert the key into the ignition switch; the system recognises the code,
- ☞ unlock the steering column by simultaneously turning the steering and the key.

i In certain cases, you may have to apply more force to the steering (wheels on full lock, for example).

- ☞ With a petrol engine, operate the starter motor by turning the key to position **3** without pressing the accelerator pedal, until the engine starts. Once the engine is running, release the key.

- ☞ With a Diesel engine, turn the key to position **2**, ignition on, to operate the engine pre-heating system.



Wait until this warning lamp goes off in the instrument panel then operate the starter motor by turning the key to position **3** without pressing the accelerator pedal, until the engine starts. Once the engine is running, release the key.

i In wintry conditions, the warning lamp can stay on for a longer period. When the engine is hot, the warning lamp does not come on. if the engine does not start straight away, switch off the ignition. Wait a few moments before operating the starter motor again. if the engine does not start after several attempts, do not keep trying: You risk damaging the starter motor or the engine. Contact a PEUGEOT dealer or a qualified workshop.

Do not leave the engine at idle to warm up but move off straight away and drive at moderate speed.



Never leave the engine running in an enclosed area without adequate ventilation: internal combustion engines emit toxic exhaust gases, such as carbon monoxide. Danger of intoxication and death.

In very severe wintry conditions (temperatures below -23°C), to ensure the correct operation and durability of the mechanical components of your vehicle, engine and gearbox, it is necessary to leave the engine running for 4 minutes before moving off. Never drive with the parking brake applied: risk of overheating and damage to the braking system.

Do not park or leave the engine running with the vehicle stationary in areas where flammable materials (dry grass, dead leaves) might come into contact with the hot exhaust system: risk of fire. Never leave the vehicle unattended with the engine running. If you have to leave the vehicle with the engine running, apply the parking brake and put the gearbox into neutral or position **P** or **N**.

Switching off the engine

- ☞ Stop the vehicle.
- ☞ With the engine running at idle, turn the key to position 1.

! In "Stop" mode of Stop & Start, don't forget to switch off the ignition.

- ☞ Remove the key from the ignition switch.
- ☞ To lock the steering column, turn the steering until it locks.

i To facilitate unlocking of the steering column, it is recommended that the wheels be returned to the straight ahead position before switching off the engine.

- ☞ Check that the parking brake is correctly applied, particularly on sloping ground.

! Never switch off the ignition before the vehicle is at a complete stop. With the engine off, the braking and steering assistance systems are also cut off: risk of loss of control of the vehicle.

i When you leave the vehicle, keep the key with you and lock the vehicle.

Energy economy mode

After switching off the engine (position **1-Stop**), for a maximum of 30 minutes you can still use functions such as the audio and telematic system, the wipers, dipped beam headlamps, courtesy lamps, ...

i For more information, refer to the "Practical information" section, under "Energy economy mode".

Avoid attaching heavy objects to the key, which would weigh down on its blade in the ignition switch and could cause a malfunction.

i Key left in the "Ignition on" position

On opening the driver's door, an alert message is displayed, accompanied by an audible signal, to remind you that the key is still in the ignition switch at position **1 (Stop)**.

If the key has been left in the ignition switch at position **2 (Ignition on)**, the ignition will be switched off automatically after one hour.

To switch the ignition back on, turn the key to position **1 (Stop)**, then back to position **2 (Ignition on)**.

Electric parking brake



The electric parking brake combines 2 operational modes:

- **Automatic application/release**
Application is automatic when the engine stops, release is automatic on use of the accelerator (activated by default),
- **Manual application/release**
The parking brake can be applied / released manually by pulling control lever **A**.



If this warning lamp comes on in the instrument panel, the automatic mode is deactivated.

Programming the mode

Depending on the country of registration of the vehicle, the automatic application when the engine is switched off and the automatic release when you press the accelerator can be deactivated.



Activation / deactivation of this function is possible by a PEUGEOT dealer or a qualified workshop.

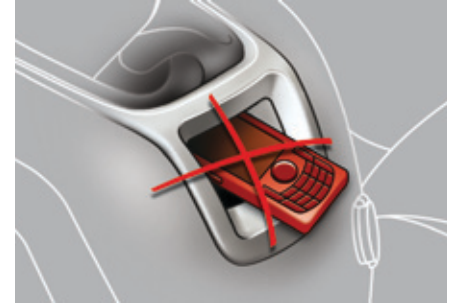

The parking brake is then applied and released manually. When the driver's door is opened, there is an audible signal and a message is displayed if the brake is not applied.

i Deactivation is recommended in particularly cold conditions (ice) and during towing (breakdown, caravan...). Refer to the "Manual release" paragraph.

! Do not place any object (packet of cigarettes, telephone, ...) behind the electric brake control.

Manual application



With the vehicle stationary, to apply the parking brake whether the engine is running or off, **pull** on the control lever **A**.

Application of the parking brake is confirmed by:



- illumination of the braking warning lamp and of the warning lamp **P** in the control lever **A**,
- display of the message "Handbrake on".



When the driver's door is opened with the engine running, a beep is heard and a message is displayed if the parking brake has not been applied, unless the selector lever is in position **P** (Park) in the case of an automatic gearbox.



Before leaving the vehicle, check that parking brake warning lamp in the instrument panel is on, not flashing.

Manual release

With the ignition on or the engine running, to release the parking brake, **press** on the **brake pedal** or the accelerator, **pull then release** the control lever **A**.

Full application of the parking brake is confirmed by:



- the braking warning lamp and of the warning lamp **P** in the control lever **A** going off,
- display of the message "Handbrake off".



If you pull the control lever **A** without pressing the brake pedal, the parking brake will not be released and a warning lamp will come on in the instrument panel.

Maximum application

If necessary, you can make a **maximum application** of the parking brake. It is obtained by means of a **long pull** on the control lever **A**, until you see the message "Handbrake on" and a beep is heard.

Maximum application is essential:

- in the case of a vehicle towing a caravan or a trailer, if the automatic functions are activated but you are applying the parking brake manually,
- when the gradient you are parked on is variable in its effect (e.g. on a ferry, in a lorry, during towing).



In the case of towing, a loaded vehicle or parking on a gradient, make a maximum application of the parking brake then turn the front wheels towards the pavement and engage a gear when you park. After a maximum application, the release time will be longer.

Automatic application, engine off

With the vehicle stationary, the parking brake **is automatically applied when the engine is switched off.**

The application of the parking brake is confirmed by:

- illumination of the braking warning lamp and of the warning lamp **P** in the control lever **A**,
- display of the message "Handbrake on".



An audible signal will confirm to you the application/ release of your electric parking brake.

- !** Before leaving the vehicle, check that parking brake warning lamp in the instrument panel is on (not flashing). Never leave a child alone inside the vehicle with the ignition on, as they could release the parking brake.

In the case of towing, a loaded vehicle or parking on a gradient, turn the front wheels towards the pavement and engage a gear when you park.

Automatic release

The electric parking brake **releases automatically and progressively** when you press the accelerator:

- ☞ **Manual gearbox:** press down fully on the clutch pedal, engage first gear or reverse, press on the accelerator pedal and move off.
- ☞ **Electronic gearbox:** select position **A**, **M** or **R** then press on the accelerator pedal.
- ☞ **Automatic gearbox:** select position **D**, **M** or **R** then press on the accelerator pedal.

Full release of the parking brake is confirmed by:

- the braking warning lamp and of the warning lamp **P** in the control lever **A** going off,
- display of the message "Handbrake off".



- !** When stationary, with the engine running, do not press the accelerator pedal unnecessarily, as you may release the parking brake.

To immobilise the vehicle, engine running

With the engine running and the vehicle stationary, in order to immobilise the vehicle it is essential to **manually** apply the parking brake by **pulling** on control lever **A**.

The application of the parking brake is confirmed by:

- illumination of the braking warning lamp and the warning lamp **P** in the control lever **A**,
- display of the message "Handbrake on".



When the driver's door is opened, an audible signal heard and a message is displayed if the parking brake has not been applied, unless the selector lever is in position **P** (Park) in the case of an automatic gearbox.

Label on the door panel



! Before leaving the vehicle, check that parking brake warning lamp in the instrument panel is on, not flashing.

i Particular situations

In certain situations (e.g. starting the engine), the parking brake can automatically alter its force. This is normal operation.

To advance your vehicle a few centimetres without starting the engine, but with the ignition on, press on the brake pedal and release the parking brake **by pulling** then **releasing** control lever **A**. The full release of the parking brake is confirmed by the warning lamp in the control lever **A** and the warning lamp in the instrument panel going off and the display of the message "Handbrake off".

If a parking brake fault occurs **while applied** or if the battery runs flat, an emergency release is always possible.

Emergency braking



In the event of a failure of the main service brake or in an exceptional situation (e.g. driver taken ill, under instruction, etc) **a continuous pull on the control lever A will stop the vehicle.**

The dynamic stability control (DSC) provides stability during emergency braking.

If there is a fault with the emergency braking, one of the following messages will be displayed:

- "Parking brake faulty".
- "Parking brake control faulty".



If a failure of the DSC system is signalled by the illumination of this warning lamp, then braking stability is not guaranteed.

In this event, stability must be assured by the driver by repeating alternate "pull release" actions on control lever **A**.



The emergency braking must only be used in exceptional circumstances.

Hill start assist

System which keeps your vehicle immobilised temporarily (approximately 2 seconds) when starting on a gradient, the time it takes to move your foot from the brake pedal to the accelerator pedal.

This system only operates when:

- the vehicle is completely stationary, with your foot on the brake pedal,
- in particular conditions on a slope,
- with the driver's door closed.

The hill start assist system cannot be deactivated.

Operation



On an ascending slope, with the vehicle stationary, the vehicle is held for a momentarily when you release the brake pedal:

- provided you are in first gear or neutral on a manual gearbox,
- provided you are in position **A** or **M** on an electronic gearbox,
- provided you are in position **D** or **M** on an automatic gearbox.



Do not exit the vehicle while it is being held in the hill start assist phase. If you need to exit the vehicle with the engine running, apply the parking brake manually then ensure that the parking brake warning lamp (and the warning lamp **P** in the lever of the electric parking brake) are on fixed (not flashing).



On a descending slope, with the vehicle stationary and reverse gear engaged, the vehicle is held momentarily when you release the brake pedal.





Operating fault





If a fault in the system occurs, these warning lamps come on. Contact a PEUGEOT dealer or a qualified workshop to have the system checked.

Operating faults

If the electric parking brake fault warning lamp comes on together with one or more of the warning lamps presented in these tables, place the vehicle in a safe condition (on level ground, gear engaged) and contact a PEUGEOT dealer or a qualified workshop without delay.

| Situations | Consequences |
|--|--|
| <p>Display of the message "Parking brake fault" and of the following warning lamps:</p>  | <ul style="list-style-type: none"> - The automatic functions are deactivated. - Hill start assist is not available. - The electric parking brake can only be used manually. |
| <p>Display of the message "Parking brake fault" and of the following warning lamps:</p>  | <ul style="list-style-type: none"> - Manual release of the electric parking brake is only available by pressing the accelerator pedal and releasing the control. - Hill start assist is not available. - The automatic functions and the manual application are still available. |
| <p>Display of the message "Parking brake fault" and of the following warning lamps:</p>  <p>and possibly</p>  <p>flashing</p> | <ul style="list-style-type: none"> - The automatic functions are deactivated. - Hill start assist is not available. <div style="background-color: #f0f0f0; padding: 10px; margin-top: 10px;"> <p>! To apply the electric parking brake:</p> <ul style="list-style-type: none"> ☞ Immobilise the vehicle and switch off the ignition. ☞ Pull the control for at least 5 seconds or until application is complete. <p>☞ Switch on the ignition and check the switching on of the electric parking brake warning lamps. The application is slower than during normal operation.</p> <p>To release the electric parking brake:</p> <ul style="list-style-type: none"> ☞ Switch on the ignition. ☞ Pull the control and hold it for approximately 3 seconds then release it. <p>If the braking warning lamp is flashing or if the warning lamps do not come on with the ignition on, these procedures will not work. Place the vehicle on level ground and have it checked by a PEUGEOT dealer or a qualified workshop.</p> </div> |

| Situations | Consequences |
|---|--|
| <p>Display of the message "Parking brake control fault - auto parking brake activated" and of the following warning lamps:</p> <p></p> <p>and possibly</p> <p></p> <p>flashing</p> | <ul style="list-style-type: none"> - Only the automatic application on switching off the engine and automatic release on acceleration functions are available. - The manual application/release of the electric parking brake and the emergency braking are not available. |
| <p>Battery fault</p> <p></p> | <ul style="list-style-type: none"> - If the battery warning lamp comes on you must stop immediately as soon as the traffic allows. Stop and immobilise your vehicle (if necessary, place the two chocks under the wheels). - Apply the electric parking brake before switching off the engine. |

Head-up display



System which projects various information onto a transparent strip in the field of vision of the driver so that they do not have to take their eyes off the road.

This system operates when the engine is running and the settings are stored when the ignition is switched off.

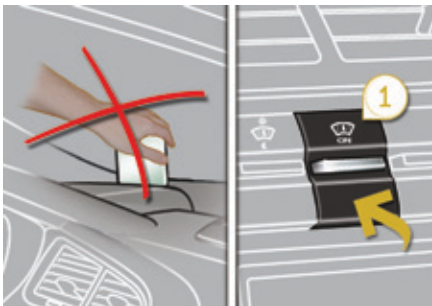

Buttons

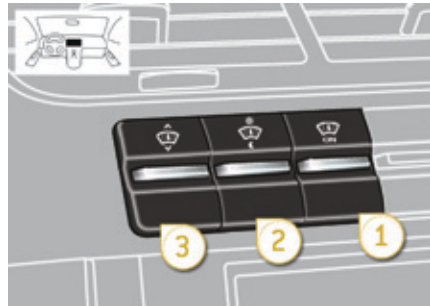

1. Head-up display on / off.
2. Brightness adjustment.
3. Display height adjustment.

i The strip is activated by pressing one of the buttons.

Displays during operation

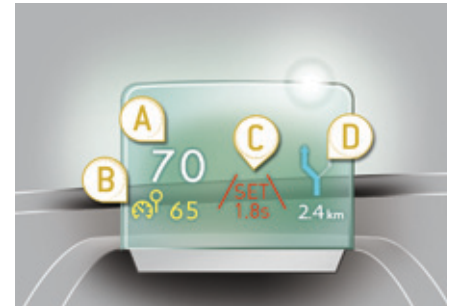

Once the system has been activated, the following information is grouped together in the head-up display:

- A. The speed of your vehicle.
- B. Cruise control/speed limiter information.
- C. "Distance alert" information (depending on version).
- D. Navigation information (depending on version).

For more information on the navigation system, refer to the "Audio equipment and telematics" section.

Activation / Deactivation

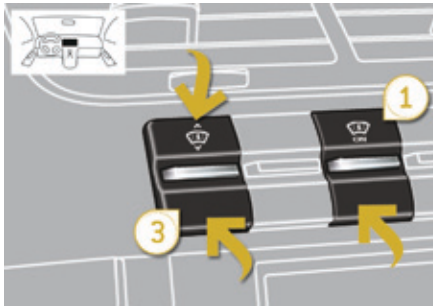

- ☞ With the engine running, press button 1. The activated/deactivated status when the engine was switched off is retained when the engine is switched on again.

Height adjustment

- ☞ With the engine running, adjust the display to the required height using button 3:
 - up to move the display up,
 - down to move the display down.

Brightness adjustment

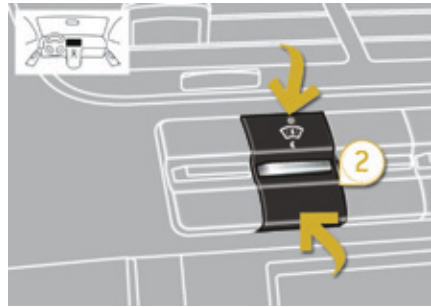

- ☞ With the engine running, adjust the brightness of the information using button 2:
 - up to increase the brightness,
 - down to decrease the brightness.

! We recommend that adjustments are only made using these buttons when the vehicle is stationary. When stationary or while driving, no objects should be placed around the transparent strip (or on its cover) to avoid blocking the strip output and preventing its correct operation.

i In certain extreme weather conditions (rain and/or snow, bright sunshine, ...) the head-up display may not be legible or may suffer temporary interference. Certain glasses (sunglasses, spectacles or polarised lenses) may hamper reading of the information. To clean the transparent strip, which is made of organic glass, use a clean, soft cloth (such as a spectacles cloth or microfibre cloth). Do not use a dry or abrasive cloth or detergent or solvent products as these could scratch the strip or damage the anti-reflection coating.

Distance alert*

Driving aid which informs the driver of the time interval (in seconds) separating them from the vehicle in front when the driving conditions are stable.

It does not detect stationary vehicles and does not itself take **any action** on your vehicle's controls.

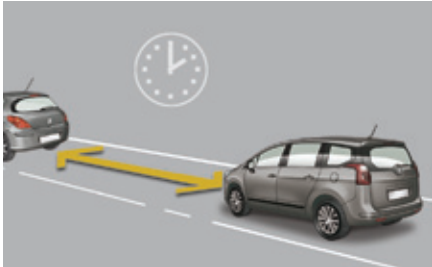

For the safety time to be observed, refer to the current legislation or highway code recommendations in your country.

The system operates when the speed of your vehicle is higher than 45 mph (70 km/h) and below 90 mph (150 km/h).

It has a programmable visual alert which remains in the memory when the ignition is switched off.

This system is a driving aid and cannot, in any circumstances, take the place of vigilance on the part of the driver.

Buttons

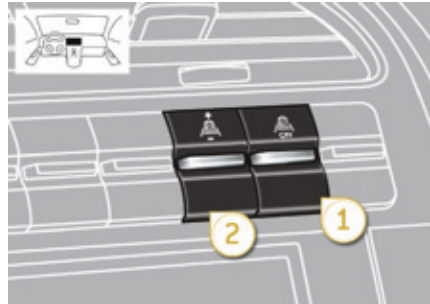

1. On / off.
2. Alert value increase (+) / decrease (-).

* Depending on version

Displays during operation

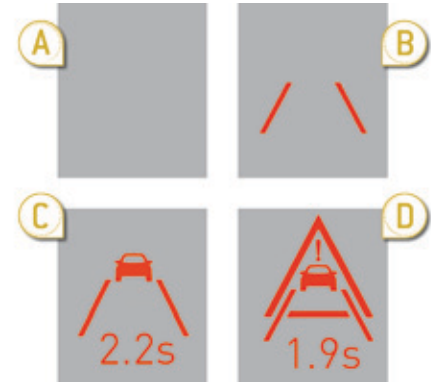

The information is grouped together in the head-up display.

Once the system has been activated:

- A. The speed of your vehicle is outside the operating range.
- B. Your vehicle is within the operating range but no vehicle has been detected.
- C. The vehicle in front of you has been detected.
The current time separating you from this vehicle is displayed permanently.
- D. The time between your vehicle and the vehicle in front is less than the programmed alert value (it flashes).

Activation

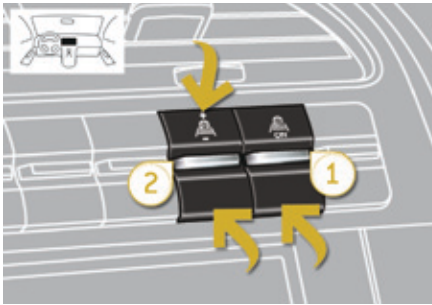

☞ Press button 1, the indicator lamp comes on.

The system is activated but will only operate from 45 mph (70 km/h).

Programming the alert value

- ☞ Select the alert value required using button 2, in steps of 0.1 second:
 - up to increase: "+",
 - down to decrease: "-".

Example with a value of 2 seconds:



The alert value can be programmed to between 0.9 second and 2.5 seconds.

The visual alert can be deactivated by programming a value of 0 second.

Alert



When the time (in seconds) between your vehicle and the vehicle in front is less than the programmed time (alert value), a visual alert flashes.

! A safety time of 2 seconds is recommended in normal driving conditions (correct traction and speed) to avoid a collision in the event of emergency braking.

Deactivation

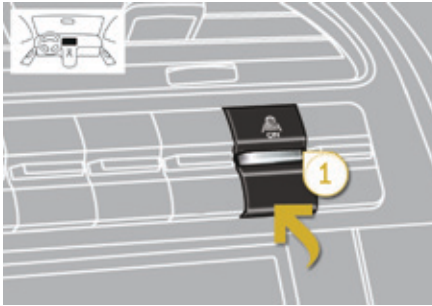

- ☞ Press button **1** to deactivate the system, the indicator lamp goes off.

Reactivation

- ☞ Press button **1** again to reactivate the system. The last value programmed is retained and the indicator lamp comes on.

Operating limits

The system switches to standby automatically if the sensor does not detect the vehicle in front correctly (very difficult weather conditions, sensor out of adjustment, ...). A message is displayed in the multifunction screen.

The vehicle being followed may not be detected in certain conditions such as, for example:

- when turning,
- when changing lane,
- when the vehicle in front is either too far ahead (maximum range of the sensor: 100 m) or stationary (in a traffic jam, ...),

When the vehicle being followed is much too near (time between the two vehicles less than 0.5 seconds), the display remains fixed at 0.5 seconds.



If the indicator lamp in button **1** flashes, have the system checked by a PEUGEOT dealer or a qualified workshop.

This system is not an anti-collision radar and it does not act of the movement of your vehicle. It provides information but cannot, in any circumstances, take the place of vigilance on the part of the driver.

Speed limiter

System which prevents the vehicle from exceeding the speed programmed by the driver.

When the programmed speed limit is reached, pressing the accelerator pedal no longer has any effect unless it is pressed firmly, which permits temporary exceeding of the programmed speed.

To return to the programmed speed, simply slow down to a speed below the programmed speed by releasing the accelerator.

The speed limiter is **switched on** manually: it requires a programmed speed of at least 20 mph (30 km/h).

The speed limiter is **switched off** by manual operation of the control.

The programmed speed remains in the memory when the ignition is switched off.

i The speed limiter cannot, in any circumstances, replace the need to observe speed limits, nor can it replace the need for vigilance on the part of the driver.

Steering mounted controls

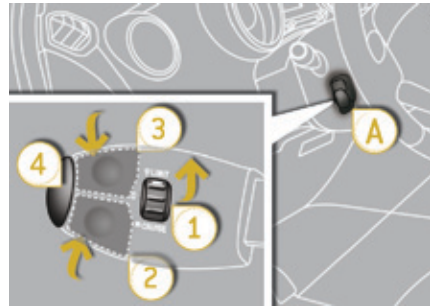

The controls of this system are grouped together on stalk **A**.

1. Speed limiter mode selection dial
2. Programmed value decrease button
3. Programmed value increase button
4. Speed limiter on / off button

Displays in the instrument panel

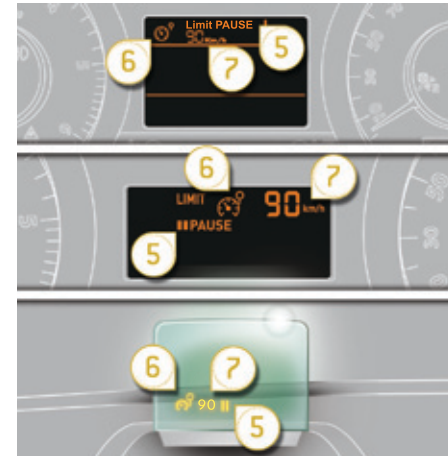

The programmed information is grouped together on the instrument panel screen.

5. Speed limiter on / off indication
6. Speed limiter mode selection indication
7. Programmed speed value

i This information also appears in the head-up display. For more information, refer to the "Head-up display" section.

Programming

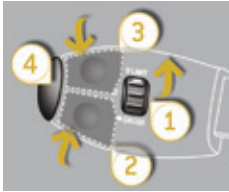

- ☞ Turn dial 1 to the **"LIMIT"** position: the speed limiter mode is selected but is not switched on (OFF/PAUSE).

You do not have to switch the speed limiter on in order to set the speed.



- ☞ Set the speed value by pressing button 2 or 3 (e.g.: 55 mph (90 km/h)).

You can then change the programmed speed using buttons 2 and 3:

- by + or - 1 mph (km/h) = short press,
 - by + or - 5 mph (km/h) = long press,
 - in steps of + or - 5 mph (km/h) = maintained press.
- ☞ Switch the speed limiter on by pressing button 4.



- ☞ Switch the speed limiter off by pressing button 4: the display confirms that it has been switched off (OFF/PAUSE).



- ☞ Switch the speed limiter back on by pressing button 4 again.

Exceeding the programmed speed



Pressing the accelerator pedal to exceed the programmed speed will not have any effect unless you press the pedal **firmly** past the **point of resistance**.

The speed limiter is deactivated temporarily and the programmed speed, which is still displayed, flashes.

Returning to the programmed speed, by means of intentional or unintentional deceleration of the vehicle, automatically cancels the flashing of the programmed speed.

Return to normal driving

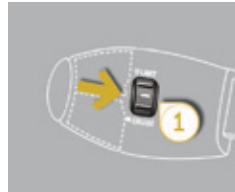

- ☞ Turn dial 1 to the "0" position: the speed limiter mode is deselected. The display returns to the distance recorder.

! On a steep descent or in the event of sharp acceleration, the speed limiter will not be able to prevent the vehicle from exceeding the programmed speed. To avoid any risk of jamming of the pedals:

- ensure that the mat is positioned correctly,
- do not fit one mat on top of another.

Operating fault



In the event of a speed limiter malfunction, the speed is cleared resulting in flashing of the dashes.

Have it checked by a PEUGEOT dealer or a qualified workshop.

Cruise control

System which automatically maintains the speed of the vehicle at the value programmed by the driver, without any action on the accelerator pedal.

The cruise control is **switched on** manually: it requires a minimum vehicle speed of 25 mph (40 km/h) and the engagement of:

- fourth gear on the manual gearbox,
- second gear in sequential mode on an electronic or automatic gearbox,
- position **A** on an electronic gearbox or **D** on an automatic gearbox.

The cruise control is **switched off** manually or by pressing the brake or clutch pedal or on triggering of the DSC/ASR systems for safety reasons.

It is possible to exceed the programmed speed temporarily by pressing the accelerator pedal. To return to the programmed speed, simply release the accelerator pedal.

Switching off the ignition cancels any programmed speed value.

Steering mounted controls

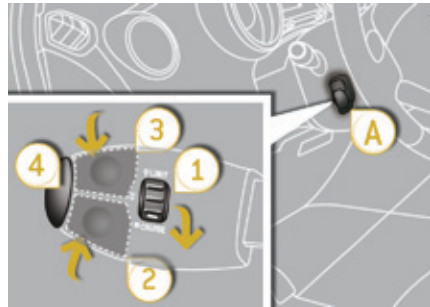

The controls of this system are grouped together on stalk **A**.

1. Cruise control mode selection dial
2. Speed programming / programmed value decrease button
3. Speed programming / programmed value increase button
4. Cruise control off / resume button

i The cruise control cannot, in any circumstances, replace the need to observe speed limits, nor can it replace the need for vigilance on the part of the driver.

Displays in the instrument panel

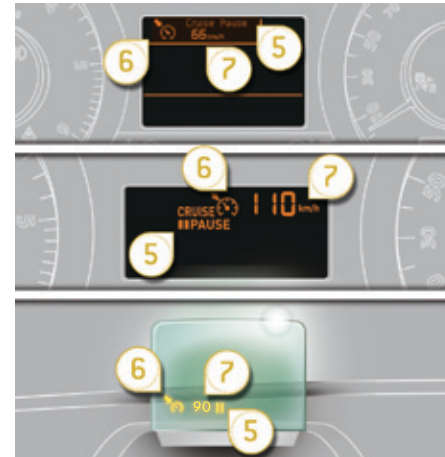

The programmed information is grouped together in the instrument panel screen.

5. Cruise control off / resume indication
6. Cruise control mode selection indication
7. Programmed speed value

i This information also appears in the head-up display. For more information, refer to the "Head-up display" section.

Programming

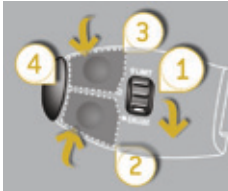

- ☞ Turn dial **1** to the "CRUISE" position: the cruise control mode is selected but is not switched on (OFF/Pause).



- ☞ Set the programmed speed by accelerating to the required speed, then press button **2** or **3** (e.g.: 70 mph (110 km/h)).

You can then change the programmed speed using buttons **2** and **3**:

- by + or - 1 mph (km/h) = short press,
- by + or - 5 mph (km/h) = long press,
- in steps of + or - 5 mph (km/h) = maintained press.



- ☞ Switch off the cruise control by pressing button **4**: the display confirms that it has been switched off (OFF/Pause).



- ☞ Switch the cruise control back on by pressing button **4** again.

Exceeding the programmed speed



Intentional or unintentional exceeding of the programmed speed results in flashing of this speed in the screen.

Return to the programmed speed, by means of intentional or unintentional deceleration of the vehicle, automatically cancels the flashing of the speed.

Return to normal driving

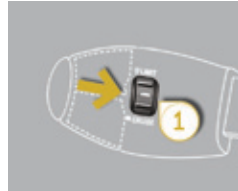

- ☞ Turn dial 1 to the "0" position: the cruise control mode is deselected. The display returns to the distance recorder.

Operating fault



In the event of a cruise control malfunction, the speed is cleared resulting in flashing of the dashes.

Have it checked by a PEUGEOT dealer or a qualified workshop.

- ! When the cruise control is switched on, be careful if you maintain the pressure on one of the programmed speed changing buttons: this may result in a very rapid change in the speed of your vehicle.

Do not use the cruise control on slippery roads or in heavy traffic. On a steep descent, the cruise control will not be able to prevent the vehicle from exceeding the programmed speed. To avoid any risk of jamming of the pedals:

- ensure that the mat is positioned correctly,
- never fit one mat on top of another.

6-speed manual gearbox

Engaging 5th or 6th gear



- ☞ Move the lever fully to the right to engage 5th or 6th gear.

Failure to observe this procedure may cause permanent damage to the gearbox (engaging 3rd or 4th gear by mistake).

Engaging reverse gear



- ☞ Raise the ring under the knob and move the gear lever to the left then forwards.

! Only engage reverse gear when the vehicle is stationary with the engine at idle.

- i** As a safety precaution and to facilitate starting of the engine:
 - always select neutral,
 - press the clutch pedal.

! When driving on flooded roads or when crossing a ford, drive at walking speed.

Electronic gearbox

Six-speed electronic gearbox which offers a choice between the comfort of fully automatic operation or the pleasure of manual gear changing.

Three driving modes are offered:

- **automatic** mode for automatic control of the gears by the gearbox,
- **manual** mode for sequential changing of the gears by the driver,
- **auto sequential** mode to overtake, for example, remaining in automatic mode while using the functions of the sequential mode.

A **Sport** function is available in automatic or sequential mode for a more dynamic style of driving.

Gear lever

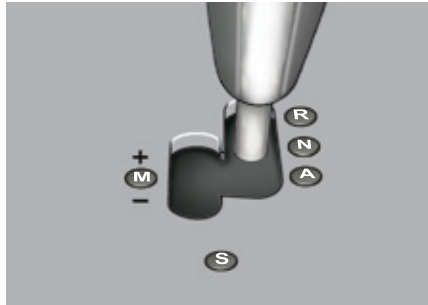

R. Reverse

- ☞ With your foot on the brake, move the lever upwards to select this position.

N. Neutral.

- ☞ With your foot on the brake, select this position to start.

A. Automatic mode.

- ☞ Move the lever downwards to select this mode.

M. + / - Manual mode with manual sequential changing of the gears.

- ☞ Move the lever downwards then to the left to select this mode, then:
 - push the lever forwards to change up a gear,
 - or pull the lever rearwards to change down a gear.

S. Sport setting.

- ☞ Press this button to activate or deactivate this function.

Steering mounted controls

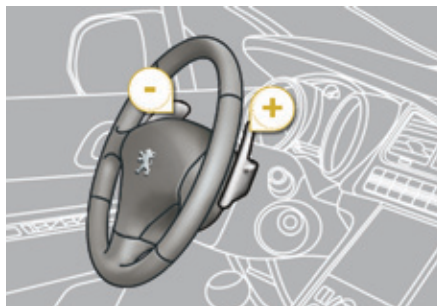

- + Change up paddle to the right of the steering wheel.
- ☞ Press the back of the "+" steering mounted paddle to change up a gear.
- Change down paddle to the left of the steering wheel.
- ☞ Press the back of the "-" steering mounted paddle to change down a gear.

i The steering mounted paddles cannot be used to select neutral or engage or disengage reverse gear.

Displays in the instrument panel

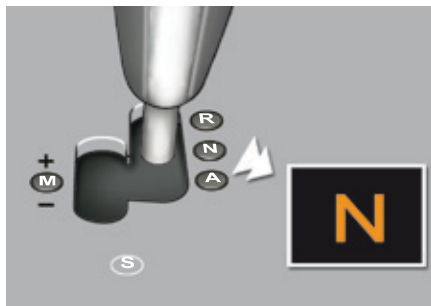

Gear lever positions

When you move the lever, the symbol corresponding to its position is displayed in the instrument panel.

N. Neutral

R. Reverse

1, 2, 3, 4, 5, 6. Gears in sequential mode **AUTO**. This comes on when the automatic mode is selected. It goes off on changing to sequential mode.

S. Sport (Sport setting)



- ☞ Place your **foot on the brake** when this warning lamp flashes (e.g.: when starting the engine).

i There is an audible signal when reverse gear is engaged.

Moving off

- ☞ Select position **N**.
- ☞ Press the brake pedal down fully.
- ☞ Start the engine.

i If the engine does not start:

- If **N** is flashing in the instrument panel, move the lever to position **A** then to position **N**.
- If the message "**Foot on brake**" is displayed, press the brake pedal firmly.

- ☞ Keep your foot on the brake pedal, move the gear lever to position **A** or **M** to go forwards, or **R** to go backwards.
- ☞ Take your foot off the brake pedal, you can then move off.
- ☞ The parking brake is released automatically, otherwise release it manually.



AUTO and **1** or **R** appear in the instrument panel screen.

! If position **R**, **A** or **M** is selected, even with the engine at idle, if the brakes are released the vehicle moves without any action on the accelerator. Never leave children unsupervised in the vehicle when the engine is running. When carrying out maintenance on the vehicle with the engine running, apply the parking brake and select position **N**.

Sequential mode

☞ When the vehicle has moved off, select position **M** to change to sequential mode.



AUTO disappears and the gears engaged appear in succession in the instrument panel screen.

The gear change requests are only carried out if the engine speed permits.

It is not necessary to release the accelerator during gear changes.

When braking or slowing down, the gearbox changes down automatically to allow vehicle to pull away in the correct gear.

i At very low speed, if reverse gear is requested, this will only be taken into account when the vehicle is immobilised. The **Foot on brake** warning lamp may flash in the instrument panel to prompt you to brake.

At high speed, if reverse gear is requested, the **N** indicator lamp will flash and the gearbox will change to neutral automatically. To engage a gear again, return the lever to position **A** or **M**.

! On sharp acceleration, the gearbox will not change up unless the driver acts on the gear lever or the steering mounted paddles.

Never select neutral **N** while the vehicle is moving.

Only engage reverse gear **R** when the vehicle is immobilised with the brake pedal pressed.

Automatic mode

☞ Following use of the sequential mode, select position **A** to return to the automatic mode.



AUTO and the gear engaged appear in the instrument panel screen.

The gearbox is then operating in auto-active mode, without any action on the part of the driver. It continuously selects the most suitable gear in relation to the following parameters:

- style of driving,
- profile of the road.

i For optimum acceleration, for example when overtaking another vehicle, press the accelerator pedal firmly past the point of resistance.

"Auto sequential mode"

This mode enables you to overtake, for example, remaining in automatic mode while using the functions of the sequential mode.

☞ Operate the **+** or **-** steering mounted paddle.

The gearbox engages the gear requested if the engine speed permits. **AUTO** is still displayed in the instrument panel.

After a few moments without any action on the controls, the gearbox resumes automatic control of the gears.

Sport setting

☞ Following selection of the sequential mode or automatic mode, press button **S** to activate the Sport setting which offers you a more dynamic style of driving.



S appears next to the gear engaged in the instrument panel screen.

☞ Press button **S** again to return to normal settings.

S is then cleared from the instrument panel screen.

i The gearbox returns to normal mode automatically each time the ignition is switched off.

Stopping the vehicle

Before switching off the engine, you can choose to:

- move to position **N** to engage neutral,
- leave the gear engaged; in this case, it will not be possible to move the vehicle.

In both cases, it is essential that you apply the parking brake to immobilise the vehicle.

! When immobilising the vehicle, with the engine running, it is essential to place the gear lever in neutral **N**.
Before carrying out any work in the engine compartment, check that the gear lever is in neutral **N** and that the parking brake is applied.

Operating fault



With the ignition on, if this warning lamp comes on and **AUTO** flashes, accompanied by an audible signal and a message in the screen, this

indicates a fault with the gearbox.

Have it checked by a PEUGEOT dealer or a qualified workshop.

! It is essential to press the brake pedal when starting the engine.
When parking, it is essential to apply the parking brake to immobilise the vehicle, whatever the circumstances.

! When driving on flooded roads or when crossing a ford, drive at walking speed.

"Porsche Tiptronic System" automatic gearbox

Six speed automatic gearbox which offers a choice between the comfort of fully automatic operation, enhanced by sport and snow programmes, or manual gear changing. Four driving modes are offered:

- **automatic** operation for electronic management of the gears by the gearbox,
- **sport** programme for a more dynamic style of driving,
- **snow** programme to improve driving when traction is poor,
- **manual** operation for sequential changing of the gears by the driver.

Gear selection gate



1. Gear lever.
2. Button "**S**" (**sport**).
3. Button "*****" (**snow**).

Gear lever



- P.** Park.
- Immobilisation of the vehicle, parking brake on or off.
 - Starting the engine.
- R.** Reverse.
- Reversing manoeuvres, vehicle stationary, engine at idle.
- N.** Neutral.
- Immobilisation of the vehicle, parking brake on.
 - Starting the engine.
- D.** Automatic operation.
- M + / -.** Manual operation with sequential changing of the six gears.
- ☞ Press forwards to change up through the gears.
- or
- ☞ Press rearwards to change down through the gears.

Displays in the instrument panel



When you move the lever in the gate to select a position, the corresponding indicator is displayed in the instrument panel.

- P.** Park
- R.** Reverse
- N.** Neutral
- D.** Drive (Automatic driving)
- S.** Sport programme
- ***. Snow programme
- 1 to 6.** Gear engaged during manual operation
- . Invalid value during manual operation

Moving off

- ☞ With your foot on the brake, select position **P** or **N**.
- ☞ Start the engine.

If this procedure is not followed, there is an audible signal, accompanied by a message in the multifunction screen.

- ☞ With the engine running, press the brake pedal.
- ☞ Release the parking brake, unless it is programmed to automatic mode.
- ☞ Select position **R**, **D** or **M**,
- ☞ Gradually release the brake pedal.

The vehicle moves off immediately.

i A message is displayed if you try to move the gear lever from position **P** without pressing the brake pedal.

i If position **N** is engaged inadvertently while driving, allow the engine to return to idle then engage position **D** to accelerate.

! When the engine is running at idle, with the brakes released, if position **R**, **D** or **M** is selected, the vehicle moves even without the accelerator being pressed. When the engine is running, never leave children in the vehicle without supervision. When carrying out maintenance with the engine running, apply the parking brake and select position **P**.

Automatic operation

- ☞ Select position **D** for **automatic** changing of the six gears.

The gearbox then operates in auto-adaptive mode, without any intervention on the part of the driver. It continuously selects the most suitable gear according to the style of driving, the profile of the road and the load in the vehicle.

For maximum acceleration without touching the lever, press the accelerator pedal down fully (kick down). The gearbox changes down automatically or maintains the gear selected until the maximum engine speed is reached. On braking, the gearbox changes down automatically to provide efficient engine braking.

If you release the accelerator sharply, the gearbox will not change to a higher gear for safety reasons.

! Never select position **N** while the vehicle is moving. Never select positions **P** or **R** unless the vehicle is completely stationary.

Sport and snow programmes

These two special programmes supplement the automatic operation in very specific conditions of use.

Sport programme "S"

☞ Press button "S", after starting the engine. The gearbox automatically favours a dynamic style of driving.



S appears in the instrument panel.

Snow programme "❄"

☞ Press button "❄", after starting the engine. The gearbox adapts to driving on slippery roads. This programme improves starting and drive when traction is poor.



❄ appears in the instrument panel.

Return to automatic operation

☞ At any time, press the button selected again to quit the programme engaged and return to auto-adaptive mode.

If the engine speed is too low or too high, the gear selected flashes for a few seconds, then the actual gear engaged is displayed.

Manual operation

- ☞ Select position **M** for **sequential** changing of the six gears.
- ☞ Push the lever towards the + sign to change up a gear.
- ☞ Pull the lever towards the - sign to change down a gear.

It is possible to change from position **D** (automatic) to position **M** (manual) at any time. When the vehicle is stationary or moving very slowly, the gearbox selects gear **M1** automatically. The sport and snow programmes do not operate in manual mode.

It is only possible to change from one gear to another if the vehicle speed and engine speed permit; otherwise, the gearbox will operate temporarily in automatic mode.



D disappears and the gears engaged appear in succession in the instrument panel.

Invalid value during manual operation



This symbol is displayed if a gear is not engaged correctly (selector between two positions).

Stopping the vehicle

Before switching off the engine, you can engage position **P** or **N** to place the gearbox in neutral.

In both cases, apply the parking brake to immobilise the vehicle, unless it is programmed to automatic mode.

i If the lever is not in position **P**, when the driver's door is opened or approximately 45 seconds after the ignition is switched off, there is an audible signal and a message appears.

- ☞ Return the lever to position **P**; the audible signal stops and the message disappears.

Operating fault



When the ignition is on, the lighting of this warning lamp, accompanied by an audible signal and a message in the multifunction screen, indicates a gearbox malfunction.

In this case, the gearbox switches to back-up mode and is locked in 3rd gear. You may feel a substantial knock when changing from **P** to **R** and from **N** to **R**. This will not cause any damage to the gearbox.

Do not exceed 60 mph (100 km/h), local speed restrictions permitting.

Have it checked by a PEUGEOT dealer or a qualified workshop.

This warning lamp may also come on if a door is opened.



You risk damaging the gearbox:

- if you press the accelerator and brake pedals at the same time,
- if you force the lever from position **P** to another position when the battery is flat.

To reduce fuel consumption when stationary for long periods with the engine running (traffic jam...), position the gear lever at **N** and apply the parking brake, unless it is programmed in automatic mode.



When driving through flooded roads or crossing a ford, drive at walking speed.

Gear shift indicator*

System which reduces fuel consumption by recommending the most appropriate gear.

Operation

Depending on the driving situation and your vehicle's equipment, the system may advise you to skip one (or more) gear(s). You can follow this instruction without engaging the intermediate gears.

The gear engagement recommendations must not be considered compulsory. In fact, the configuration of the road, the amount of traffic and safety remain determining factors when choosing the best gear. Therefore, the driver remains responsible for deciding whether or not to follow the advice given by the system. This function cannot be deactivated.

The system adapts its gear change recommendation according to the driving conditions (slope, load, ...) and the demands of the driver (power, acceleration, braking, ...).

- The system never suggests:
- engaging first gear,
 - engaging reverse gear,

- The system may suggest that you engage a higher gear.



The information appears in the instrument panel in the form of an arrow.

Example:

- You are in third gear.



- You press the accelerator pedal.



* Depending on engine.

Stop & Start

The Stop & Start system puts the engine temporarily into standby - STOP mode - during stops in the traffic (red lights, traffic jams, or other...). The engine restarts automatically - START mode - as soon as you want to move off. The restart takes place instantly, quickly and silently.

Perfect for urban use, the Stop & Start system reduces fuel consumption and exhaust emissions as well as the noise level when stationary.

Operation

Going into engine STOP mode

ECO The "ECO" warning lamp comes on in the instrument panel and the engine goes into standby:

- **with a manual gearbox**, at speeds below 12 mph (20 km/h), or vehicle stationary with the e-THP 165 version, when you put the gear lever into neutral and release the clutch pedal,
- **with an electronic gearbox**, at speeds below 4 mph (6 km/h), when you press the brake pedal or you put the gear selector in position **N**,

- **with an automatic gearbox**, vehicle stationary, when you press the brake pedal or you put the gear selector in position **N**.

i If your vehicle is fitted with the system, a time counter calculates the sum of the periods in STOP mode during a journey. It rests itself to zero every time the ignition is switched on with the key.

i For your comfort, during parking manoeuvres, STOP mode is not available for a few seconds after coming out of reverse gear. STOP mode does not affect the functionality of the vehicle, such as for example, braking, power steering...

! Never refuel with the engine in STOP mode; you must switch off the ignition with the key.

Special cases: STOP mode not available

STOP mode is not invoked when:

- the driver's door is open,
- the driver's seat belt is not fastened,
- the vehicle has not exceeded 6 mph (10 km/h) since the last engine start using the key,
- the vehicle is stopped on a steep slope (up or down),
- the electric parking brake is applied or being applied,
- the engine is needed to maintain a comfortable temperature in the passenger compartment,
- demisting is active,
- some special conditions (battery charge, engine temperature, braking assistance, ambient temperature...) where the engine is needed to assure control of a system.

ECO In this case, the "ECO" warning lamp flashes for a few seconds then goes off.

This operation is perfectly normal.

Going into engine START mode

ECO The "ECO" warning lamp goes off and the engine starts automatically:

- **with a manual gearbox**, when you fully depress the clutch pedal,
- **with an electronic gearbox**:
 - gear selector in position **A** or **M**, when you release the brake pedal,
 - or gear selector in position **N** and brake pedal released, when you put the gear selector in position **A** or **M**,
 - or when you engage reverse gear.
- **with an automatic gearbox**:
 - gear selector in position **D** or **M**, when you release the brake pedal,
 - or gear selector in position **N** and brake pedal released, when you put the gear selector in position **D** or **M**,
 - or when you engage reverse gear.

Special cases: START invoked automatically

START mode is invoked automatically when:

- the driver's door is open,
- the driver's seat belt is not fastened,
- the speed of the vehicle exceeds 18 mph (25 km/h) with a manual gearbox, (2 mph (3 km/h) with the THP 165 version), 7 mph (11 km/h) with an electronic gearbox or 2 mph (3 km/h) with an automatic gearbox,
- the electric parking brake is being applied,
- some special conditions (battery charge, engine temperature, braking assistance, ambient temperature...) where the engine is needed for control of a system.

ECO In this case the "ECO" warning lamp flashes for a few seconds, then goes off.

This operation is perfectly normal.

Deactivation

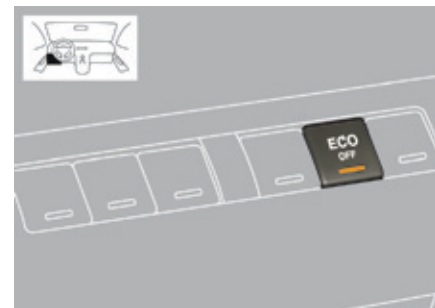

At any time, press the "ECO OFF" switch to deactivate the system.

This is confirmed by the switch warning lamp coming on accompanied by a message in the screen.

i If the system has been deactivated in STOP mode, the engine restarts immediately.

Reactivation

Press the **"ECO OFF"** switch again.

The system is active again; this is confirmed by the switch warning lamp going off and a message in the screen.

i The system is reactivated automatically at every new start using the key.

Operating fault

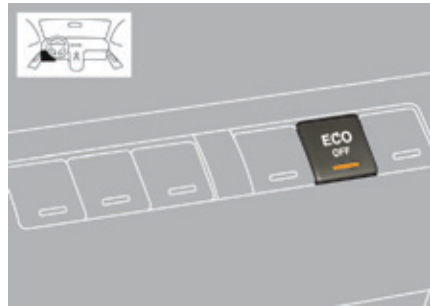

In the event of a fault with the system, the **"ECO OFF"** switch warning lamp flashes then comes on continuously.

Have it checked by a PEUGEOT dealer or a qualified workshop.

In the event of a fault in STOP mode, the vehicle may stall: all the instrument panel warning lamps come on. It is then necessary to switch off the ignition and start the engine again using the key.

! When driving on flooded roads or crossing a ford, switch off the Stop & Start and drive at walking speed.

Maintenance

! Before doing anything under the bonnet, deactivate the Stop & Start system to avoid any risk of injury resulting from automatic operation of START mode.

This system requires a 12 V battery with a special specification and technology (reference numbers available from PEUGEOT dealers).

Fitting a battery not listed by PEUGEOT introduces the risk of malfunction of the system.

To charge the battery, use a 12 V charger and observe the polarity.

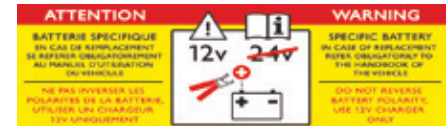

! The Stop & Start system makes use of advanced technology. For any work on the system go to a qualified workshop with the skills and equipment required, which a PEUGEOT dealer is able to provide.

Tyre under-inflation detection



System which automatically checks the pressures of the tyres while driving.

The system continuously monitors the pressures of the four tyres, as soon as the vehicle is moving.

A pressure sensor is located in the valve of a each tyres (except the spare wheel).

The system triggers an alert if a drop in pressure is detected in one or more tyres.

! The tyre under-inflation detection system is an aid to driving which does not replace the need for the driver to be vigilant or to drive responsibly.

! This system does not avoid the need to check the tyre pressures regularly (including the spare wheel) and before a long journey. Driving with under-inflated tyres adversely affects road holding, extends braking distances and causes premature tyre wear, particularly under arduous conditions (vehicle loaded, high speed, long journey).

☘ Driving with under-inflated tyres increases fuel consumption.

! The tyre pressures for your vehicle can be found on the tyre pressure label (see the "Identification markings" section). The tyre pressures must be checked when the tyres cold (vehicle stopped for 1 hour or after driving for less than 6 miles (10 km) at moderate speed). Otherwise, add 0.3 bar to the values indicated on the label.

Under-inflation alert



The alert is given by the fixed illumination of this warning lamp, accompanied by an audible signal, and depending on equipment, the display of a message.



In the event of a problem on one of the tyres, the symbol or the message appears, according to equipment, to identify it.

! The loss of pressure detected does not always lead to visible deformation of the tyre. Do not rely on just a visual check.

- ☞ Reduce speed, avoid sudden steering movements or harsh brake applications.
- ☞ Stop as soon as it is safe to do so.
- ☞ If you have a compressor (the one in the temporary puncture repair kit for example), check the four tyre pressures when cold. If it is not possible to check the tyre pressures at the time, drive carefully at reduced speed.
- or
- ☞ In the event of a puncture, use the temporary puncture repair kit or the spare wheel (according to equipment).

i The alert is maintained until the tyre or tyres concerned is reinflated, repaired or replaced.
The spare wheel (space-saver type or a steel rim) does not have a sensor.

Operating fault



The flashing and then fixed illumination of the under-inflation warning lamp accompanied by the illumination of the "service" warning lamp indicates a fault with the system.

i This alert is also displayed when one or more wheels is not fitted with a sensor (for example, a space-saver or steel spare wheel).

In this case, monitoring of the tyre pressures is not assured.

i Go to a PEUGEOT dealer or a qualified workshop to have the system checked or, following the repair of a puncture, to have the original wheel, equipped with a sensor, refitted.

Visual and audible front and rear parking sensors

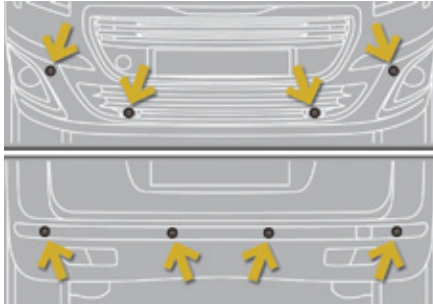

System consisting of four proximity sensors, installed in the front and/or rear bumper. It detects any obstacle (person, vehicle, tree, barrier...) located behind the vehicle, however, it will not be able to detect obstacles located immediately below the bumper.

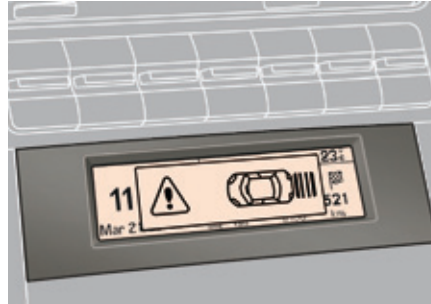

The parking sensors are **switched on**:

- by engaging reverse gear,
- at a speed below 6 mph (10 km/h) in forward gear.

This is accompanied by an audible signal and display of the vehicle in the multifunction screen.



The proximity information is indicated by:

- an audible signal which becomes more rapid as the vehicle approaches the obstacle,
- a graphic in the multifunction screen, with blocks which move closer to the vehicle.

The obstacle is located in relation to the emission of the audible signal by the speakers; front or rear and right or left.

When the distance between the vehicle and the obstacle is less than approximately thirty centimetres, the audible signal becomes continuous and/or the "Danger" symbol appears, depending on the multifunction screen version.

i An object, such as a stake, a roadworks cone or any other similar object may be detected at the start of the manoeuvre but may no longer be detected when the vehicle moves nearer to it.

The parking sensors are **switched off**:

- when you exit reverse gear,
- when the speed is higher than 6 mph (10 km/h) in forward gear,
- when the vehicle has been stationary for more than three seconds in forward gear.

i The parking sensor system cannot, in any circumstances, replace the need for vigilance on the part of the driver.

Deactivation



- ☞ Press button **A**, the warning lamp comes on, the system is fully deactivated.

i The system will be deactivated automatically when a trailer is being towed or when a bicycle carrier is fitted (vehicle fitted with a towbar or bicycle carrier recommended by PEUGEOT).

Reactivation

- ☞ Press button **A** again, the warning lamp switches off, the system is reactivated.

Operating fault



If an operating fault occurs, this warning lamp is displayed in the instrument panel and/or a message appears in the multifunction screen, accompanied by an audible signal (short beep), when reverse gear is engaged. Contact a PEUGEOT dealer or a qualified workshop.

i In bad weather or in winter, ensure that the sensors are not covered with mud, ice or snow. When reverse gear is engaged, an audible signal (long beep) indicates that the sensors may be dirty. When the vehicle is being driven at a speed below approximately 6 mph (10 km/h), certain sources of noise (motorcycles, lorries, pneumatic drills, ...) may trigger the parking sensor audible signals.

Reversing camera



The reversing camera is activated automatically when reverse gear is engaged. The colour image is provided in the navigation screen.

! This system is a driving aid that does not replace vigilance on the part of the driver, who must remain in control of the vehicle at all times.

i Clean the lens of the reversing camera regularly using a sponge and a soft cloth. When cleaning the vehicle with a high pressure jet wash, keep the end of the lance at least 30 cm from the camera lens.



The green lines represent the general direction of the vehicle.

The red lines represent around 30 cm beyond the limit of your vehicle's rear bumper. The blue lines represent the maximum turning circle.

i The lines displayed in the screen do not allow the position of the vehicle to be determined relative to tall obstacles (for example: vehicles nearby). Some deformation of the image is normal.

Parking space sensors

After measuring the parking space available between two vehicles or obstacles, this system gives you information on:

- the possibility of fitting into a free space, depending on the dimensions of your vehicle and the distances needed for manoeuvring,
- the level of difficulty of the manoeuvre to be performed.

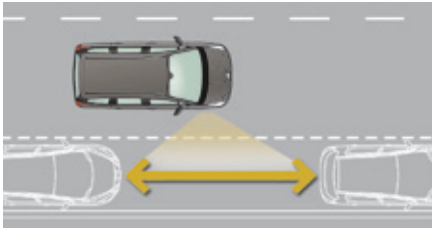

The system does not measure spaces which are clearly much smaller or larger than the size of the vehicle.

Displays in the instrument panel



The parking space sensor function warning lamp can have three different states:

- **off:** the function is not selected,
- **on fixed:** the function is selected but the conditions for measurement are not yet met (direction indicator not operating, speed too high) or the measurement phase has ended,
- **flashing:** measurement is in progress or the message is being displayed.



You can activate the "parking space sensor" function by pressing button **A**. The fixed illumination of the warning lamp indicates that the function is selected.

Operation

You have identified a parking space:

- ☞ Press button **A** to activate the function.
- ☞ Activate the direction indicator on the side where the space is to be measured.
- ☞ During the measuring, go forward the length of the space, at a speed less than 12 mph (approximately 20 km/h), to prepare for your manoeuvre.

The system then measures the size of the space.

- ☞ The system informs you of the level of difficulty of the manoeuvre via a message in the multifunction screen accompanied by an audible signal.

The function displays the following types of message:

Parking possible



Parking difficult



Parking not advised

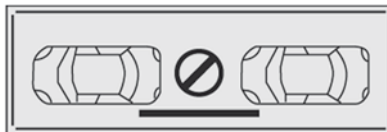

The function deactivates itself automatically:

- when you engage reverse gear,
- when you switch off the ignition,
- five minutes after activation of the function or after the last measurement operation,
- if the vehicle speed exceeds the threshold of 45 mph (approximately 70 km/h) for one minute.

! If the lateral distance between your vehicle and the parking space is too great, the system may not operate.

- i** - The function remains available after each measurement and so can measure a number of places successively.
- In bad weather or in winter, ensure that the sensors are not covered by dirt, or by ice or snow.
- The parking space sensor function deactivates the front parking sensors during the space measuring phase when you are in forward gear.

If there is a malfunction, have the system checked by a PEUGEOT dealer or a qualified workshop.

Fuel tank

Capacity of the tank: approximately 60 litres.

Low fuel level



When the low fuel level is reached, this warning lamp comes on in the instrument panel, accompanied by an audible signal and a message in the multifunction screen. When the lamp first comes on, there is **approximately 6 litres** of fuel remaining.

Until sufficient fuel has been added, this warning lamp appears every time the ignition is switched on, accompanied by an audible signal and a message. When driving, this audible signal and message are repeated with increasing frequency, as the fuel level drops towards "0".

- i** You must refuel to avoid running out of fuel.
If you run out of fuel (Diesel), refer also to the "Checks" section.

Refuelling

A label affixed to the inside of the filler flap reminds you of the type of fuel to be used according to your engine.

More than 5 litres of fuel must be added in order to be registered by the fuel gauge.

- i** The key cannot be removed from the lock until the cap is put back on the tank.
Opening the cap may trigger an inrush of air. This vacuum, which is completely normal, is caused by the sealing of the fuel system.

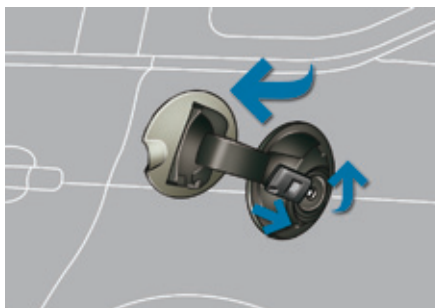

To fill the tank safely:

- ☞ **the engine must be switched off,**
- ☞ open the fuel filler flap,
- ☞ insert the key in the cap, then turn it to the left,



- ☞ remove the cap and secure it on the hook, located on the inside of the flap,
- ☞ fill the tank, but **do not continue after the 3rd cut-off of the nozzle**; this could cause malfunctions.

When refuelling is complete:

- ☞ put the cap back in place,
- ☞ turn the key to the right, then remove it from the cap,
- ☞ close the filler flap.

Operating fault

A malfunction of the fuel gauge is indicated by the return to zero of the fuel gauge needle. Have it checked by a PEUGEOT dealer or a qualified workshop.



With Stop & Start, never refuel with the system in STOP mode; you must switch off the ignition with the key.

Quality of the fuel used for petrol engines



The petrol engines are perfectly compatible with E10 type petrol biofuels (containing 10 % ethanol), conforming to European standards EN 228 and EN 15376.

E85 type fuels (containing up to 85 % ethanol) are reserved exclusively for vehicles marketed for the use of this type of fuel (BioFlex vehicles). The quality of the ethanol must comply with European standard EN 15293.

For Brazil only, special vehicles are marketed to run on fuels containing up to 100 % ethanol (E100 type).

Quality of the fuel used for Diesel engines



The Diesel engines are perfectly compatible with biofuels which conform to current and future European standards (Diesel fuel which complies with standard EN 590 mixed with a biofuel which complies with standard EN 14214) available at the pumps (containing up to 7 % Fatty Acid Methyl Ester).

The B30 biofuel can be used in certain Diesel engines; however, this use is subject to strict application of the special servicing conditions. Contact a PEUGEOT dealer or a qualified workshop.

The use of any other type of (bio)fuel (vegetable or animal oils, pure or diluted, domestic fuel...) is strictly prohibited (risk of damage to the engine and fuel system).

Bonnet

Opening

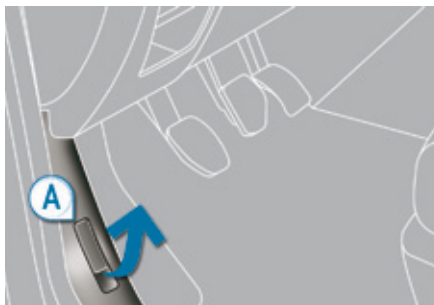

- ☞ Open the front left door.
- ☞ Pull the interior bonnet release lever **A**, located at the bottom of the door aperture.

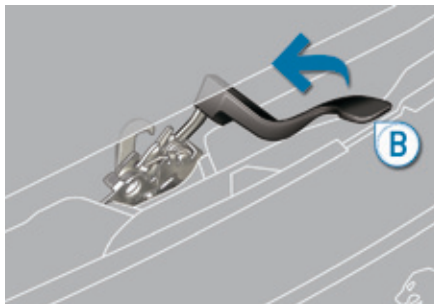

- ☞ Push the exterior safety catch **B** to the left and raise the bonnet.

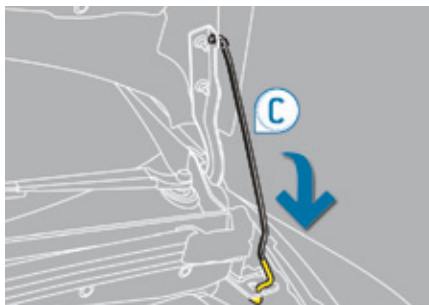

- ☞ Unclip the stay **C** from its housing.
- ☞ Fix the stay in the notch to hold the bonnet open.

Closing

- ☞ Take the stay out of the support notch.
- ☞ Clip the stay in its housing.
- ☞ Lower the bonnet and release it at the end of its travel.
- ☞ Pull on the bonnet to check that it is secured correctly.

i The location of the interior bonnet release lever prevents opening of the bonnet while the front left door is closed.

Do not open the bonnet in high winds. When the engine is hot, handle the exterior safety catch and the bonnet stay with care (risk of burns).

! Before doing anything under the bonnet, switch off the Stop & Start system to avoid any risk of injury resulting from an automatic change to START mode.

The cooling fan may start after switching off the engine: take care with articles and clothing that might become caught by the fan blades.

Because of the presence of electrical equipment under the bonnet, it is recommended that exposure to water (rain, washing, ...) be limited.

Underbonnet - petrol engines

The various caps and covers allow access for checking the levels of the various fluids and for replacing certain components.

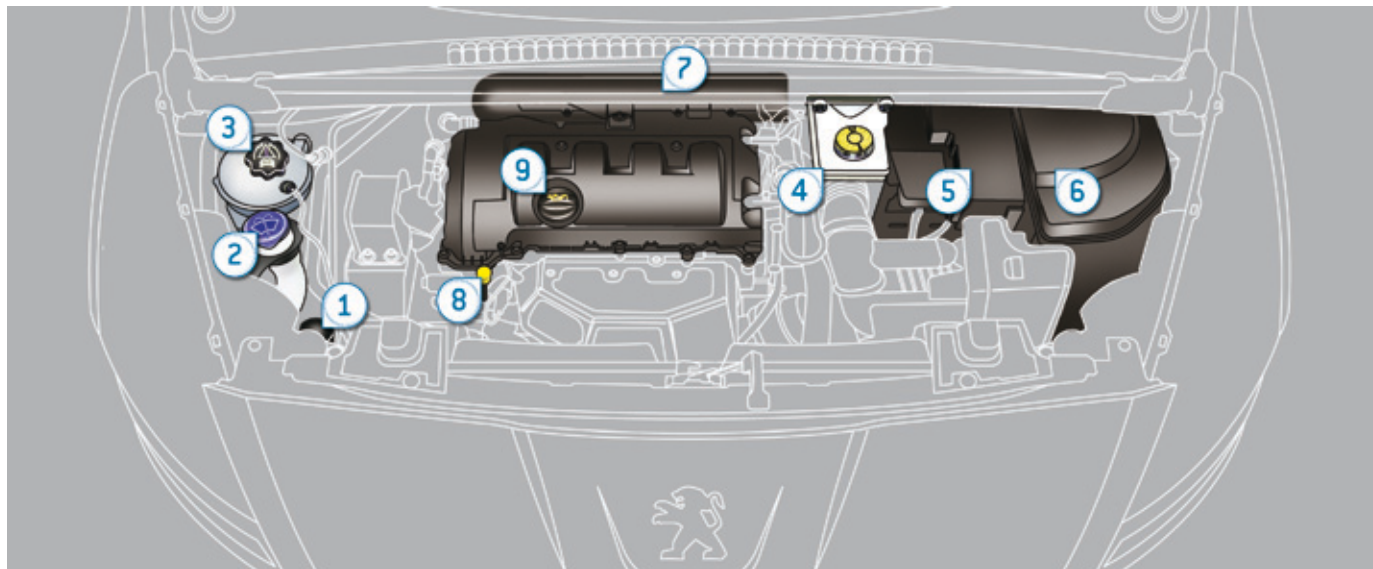

1. Power steering reservoir.

2. Screenwash and headlamp wash reservoir.

3. Coolant header tank.

4. Brake fluid reservoir.

5. Battery / Fuses.

6. Fusebox.

7. Air filter.

8. Engine oil dipstick.

9. Engine oil filler cap.

Underbonnet - Diesel engines

The various caps and covers allow access for checking the levels of the various fluids, for replacing certain components and for priming the fuel system.

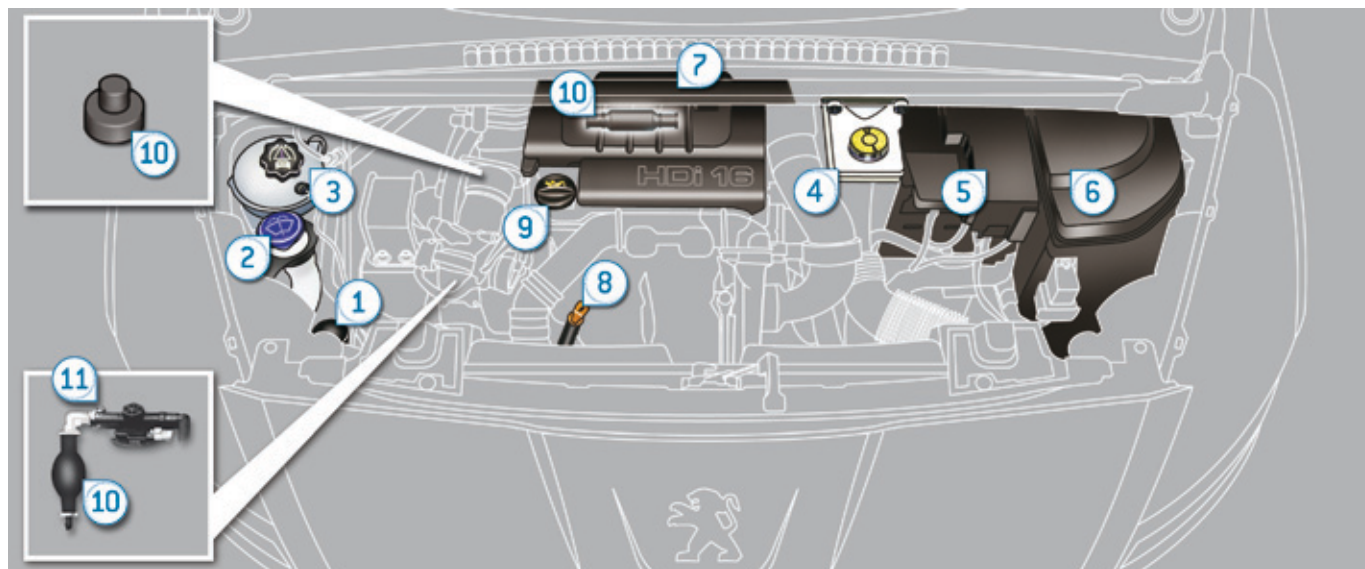

- | | | |
|--|-------------------------|---------------------------|
| 1. Power steering reservoir. | 5. Battery / Fuses. | 9. Engine oil filler cap. |
| 2. Screenwash and headlamp wash reservoir. | 6. Fusebox. | 10. Priming pump*. |
| 3. Coolant header tank. | 7. Air filter. | 11. Bleed screw*. |
| 4. Brake fluid reservoir. | 8. Engine oil dipstick. | |

* Depending on engine.

Checking levels

Check all of these levels regularly, in line with the warranty and maintenance record. Top them up if necessary, unless otherwise indicated. If a level drops significantly, have the corresponding system checked by a PEUGEOT dealer or a qualified workshop.

! Take care when working under the bonnet, as certain areas of the engine may be extremely hot (risk of burns) and the cooling fan could start at any time (even with the ignition off).

Engine oil level



The check is carried out either when the ignition is switched on using the oil level indicator in the instrument panel for vehicles with an electric oil level gauge, or using the dipstick.

To ensure that the reading is correct, your vehicle must be parked on a level surface with the engine having been off for more than 30 minutes.

It is normal to top up the oil level between two services (or oil changes). PEUGEOT recommends that you check the level, and top up if necessary, every 3 000 miles (5 000 kms).

Checking using the dipstick

Refer to the "Petrol engine" or "Diesel engine" section for the location of the dipstick in the engine compartment of your vehicle.

- ☞ Take the dipstick by its coloured grip and remove it completely.
- ☞ Wipe the end of the dipstick using a clean non-fluffy cloth.
- ☞ Refit the dipstick and push fully down, then pull it out again to make the visual check: the correct level is between the marks **A** and **B**.



A = MAX

B = MIN

If you find that the level is above the **A** mark or below the **B** mark, **do not start the engine**.

- If the level is above the **MAX** mark (risk of damage to the engine), contact a PEUGEOT dealer or a qualified workshop.
- If the level is below the **MIN** mark, you must top up the engine oil.

Oil grade

Before topping-up the oil or changing the oil, check that the oil is the correct grade for your engine and conforms to the manufacturer's recommendations.

Topping up the engine oil level

Refer to the "Petrol engine" or "Diesel engine" section for the location of the oil filler cap in the engine compartment of your vehicle.

- 🔧 Unscrew the oil filler cap to reveal the filler aperture.
- 🔧 Add oil in small quantities, avoiding any spills on engine components (risk of fire).
- 🔧 Wait a few minutes before checking the level again using the dipstick.
- 🔧 Add more oil if necessary.
- 🔧 After checking the level, carefully refit the oil filler cap and the dipstick in its tube.

i After topping up the oil, the check when switching on the ignition with the oil level indicator in the instrument panel is not valid during the 30 minutes after topping up.

Engine oil change

Refer to the warranty and maintenance record for details of the interval for this operation. In order to maintain the reliability of the engine and emission control system, never use additives in the engine oil.

Brake fluid level



The brake fluid level should be close to the "MAX" mark. If it is not, check the brake pad wear.

Changing the fluid

Refer to the warranty and maintenance record for details of the interval for this operation.

Fluid specification

The brake fluid must conform to the manufacturer's recommendations.

Power steering fluid level



The power steering fluid level should be close to the "MAX" mark. With the engine cold, unscrew the cap to check the level.

Coolant level



The coolant level should be close to the "MAX" mark but should never exceed it.

When the engine is warm, the temperature of the coolant is regulated by the fan.

The cooling fan may start after switching off the engine: take care with articles and clothing that might become caught by the fan blades.

In addition, as the cooling system is pressurised, wait at least one hour after switching off the engine before carrying out any work.

To avoid any risk of scalding, unscrew the cap by two turns to allow the pressure to drop. When the pressure has dropped, remove the cap and top up the level.

Fluid specification

The coolant must conform to the manufacturer's recommendations.

Screenwash and headlamp wash fluid



In the case of vehicles fitted with headlamp washers, the low fluid level is indicated by an audible signal and a message in the instrument panel screen.

Top up the reservoir when you next stop the vehicle.

Fluid specification

For optimum cleaning and to avoid freezing, this fluid must not be topped up with or replaced with plain water.

i In wintry conditions, the use of an ethyl alcohol or methanol base fluid is recommended.

Diesel additive level (Diesel engine with particle emission filter)



A low additive level is indicated by illumination of the service warning lamp, accompanied by an audible warning and a message in the instrument panel screen.

Topping up

This additive must be topped up by a PEUGEOT dealer or a qualified workshop without delay.

Used products

! Avoid prolonged contact of used oil or fluids with the skin. Most of these fluids are harmful to health or indeed very corrosive.



Do not discard used oil or fluids into sewers or onto the ground. Take used oil to a PEUGEOT dealer or a qualified workshop (France) or to an authorised waste disposal site.

Checks

Unless otherwise indicated, check these components in accordance with the warranty and maintenance record and according to your engine.

Otherwise, have them checked by a PEUGEOT dealer or a qualified workshop.

12 V battery



The battery does not require any maintenance. However, check that the terminals are clean and correctly tightened, particularly in summer and winter.

When carrying out work on the battery, refer to the "12 V battery" section for details of the precautions to be taken before disconnecting the battery and following its reconnection.

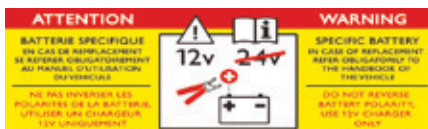

i The presence of this label, in particular with the Stop & Start system, indicates the use of a specific 12 V lead-acid battery with special technology and specification. The involvement of a PEUGEOT dealer or a qualified workshop is essential when replacing or disconnecting the battery.

Air filter and passenger compartment filter



Refer to the warranty and maintenance record for details of the replacement intervals for these components.

Depending on the environment (e.g. dusty atmosphere) and the use of the vehicle (e.g. city driving), **replace them twice as often if necessary**.

A clogged passenger compartment filter may have an adverse effect on the performance of the air conditioning system and generate undesirable odours.

Oil filter



Replace the oil filter each time the engine oil is changed.

Refer to the warranty and maintenance record for details of the replacement interval for this component.

Particle emission filter (Diesel)



The start of saturation of the particle filter is indicated by the temporary illumination of this warning lamp accompanied by a message in the multi-function screen.

As soon as the traffic conditions permit, regenerate the filter by driving at a speed of at least 40 mph (60 km/h) until the warning lamp goes off.

If the warning lamp stays on, this indicates a low additive level.

i On a new vehicle, the first particle filter regeneration operations may be accompanied by a "burning" smell, which is perfectly normal. Following prolonged operation of the vehicle at very low speed or at idle, you may, in exceptional circumstances, notice the emission of water vapour at the exhaust on acceleration. This does not affect the behaviour of the vehicle or the environment.

Manual gearbox



The gearbox does not require any maintenance (no oil change). Refer to the warranty and maintenance record for the checking interval for this component.

Electronic gearbox



The gearbox does not require any maintenance (no oil change). Refer to the warranty and maintenance record for details of the level checking interval for this component.

Automatic gearbox



The gearbox does not require any maintenance (no oil change). Refer to the warranty and maintenance record for details of the level checking interval for this component.

Brake pads



Brake wear depends on the style of driving, particularly in the case of vehicles used in town, over short distances. It may be necessary to have the condition of the brakes checked, even between vehicle services. Unless there is a leak in the circuit, a drop in the brake fluid level indicates that the brake pads are worn.

Brake disc wear



For information on checking brake disc wear, contact a PEUGEOT dealer or a qualified workshop.

i Only use products recommended by PEUGEOT or products of equivalent quality and specification. In order to optimise the operation of units as important as those in the braking system, PEUGEOT selects and offers very specific products. After washing the vehicle, dampness, or in wintry conditions, ice can form on the brake discs and pads: braking efficiency may be reduced. Make light brake applications to dry and defrost the brakes.

Electric parking brake



This system does not require any routine servicing. However, in the event of a problem, have the system checked by a PEUGEOT dealer or a qualified workshop.

i For more information, refer to the "Electric parking brake - Operating faults" section.

Range indicators

When switching on the ignition, an indicator gives an estimate of the distance that can be travelled with your vehicle before engine starting is automatically prevented, once the vehicle starts using the reserve of AdBlue® or after a fault is detected with the SCR system. In the event of simultaneous system fault and low AdBlue® level, the shortest range is the one displayed.

In the event of the risk of non-starting related to a lack of AdBlue®

! The engine start prevention system required by regulations is activated automatically once the AdBlue® tank is empty.

Range greater than 1 500 miles (2 400 km)

When the ignition is switched on, no information on range is displayed automatically in the instrument panel.



Pressing this button displays the driving range temporarily.
Above 3 000 miles (5 000 km), the value is not specified.

Remaining range between 350 and 1500 miles (600 and 2 400 km)



When switching on the ignition, the UREA warning lamp comes on, accompanied by an audible signal and the display of a message (e.g.: "Top up emissions additive: Starting prevented in 900 miles") indicating the remaining range expressed in miles or kilometres.

When driving, the message is displayed every 150 miles (300 km) until the additive tank has been topped-up.

Go to a PEUGEOT dealer or a qualified workshop to have the AdBlue® tank topped-up. You can also top-up the tank yourself. Refer to the "Topping-up" section.

Remaining range between 0 and 350 miles (0 and 600 km)



When switching on the ignition, the SERVICE warning lamp comes on and the UREA warning lamp flashes, accompanied by an audible signal and the display of a message (e.g. "Top up emissions additive: Starting prevented in 350 miles") indicating the remaining range expressed in miles or kilometres.

When driving, the message is displayed every 30 seconds until the additive tank has been topped-up.

Go to a PEUGEOT dealer or a qualified workshop to have the AdBlue® tank topped-up. You can also top-up the tank yourself. Refer to the "Topping-up" section. If you fail to do this, there is a risk that you will not be able to start your engine.

Breakdown related to a lack of AdBlue® additive



When switching on the ignition, the SERVICE warning lamp comes on and the UREA warning lamp flashes, accompanied by an audible signal and the display of the message "Top up emissions additive: Starting prevented". The AdBlue® tank is empty: the system required by regulations prevents engine starting.

! To be able to start the engine, we recommend that you call on a PEUGEOT dealer or a qualified workshop for the top-up required. If you carry out the top-up yourself, it is essential to add at least 3.8 litres of AdBlue® to the tank. Refer to the "Topping-up" section.

In the event of a fault with the SCR emissions control system

! A system that prevents engine starting is activated automatically from 650 miles (1 100 km) after confirmation of a fault with the SCR emissions control system. Have the system checked by a PEUGEOT dealer or a qualified workshop as soon as possible.

In the event of the detection of a fault

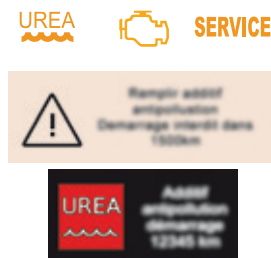

When switching on the ignition, the UREA, SERVICE and diagnostic warning lamps come on, accompanied by an audible signal and the display of a message "Emissions fault" to signal a fault with the emissions control system.

i If it is a temporary fault, the alert disappears once the exhaust gas emissions return to normal.

During an authorised driving phase (between 650 miles and 0 miles) (1 100 km and 0 km)

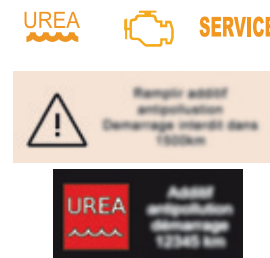

If a fault with the SCR system is confirmed (after 30 miles (50 km) covered with the permanent display of the message signalling a fault), when switching on the ignition, the SERVICE and engine diagnostic warning lamps come on and the UREA warning lamp flashes, accompanied by an audible signal and the display of a message (e.g.: "Emissions fault: Starting prevented in 150 miles") indicating the remaining range express in miles or kilometres. While driving, the message is displayed every 30 seconds while the fault with the SCR system persists. You should go to a PEUGEOT dealer or a qualified workshop as soon as possible. If you fail to do this, there is a risk that you will not be able to start your engine.

Starting prevented



Every time the ignition is switched on, the SERVICE and engine diagnostic warning lamps come on and the UREA warning lamp flashes, accompanied by an audible signal and the display of the message "Emissions fault: Starting prevented".

! You have exceeded the authorised driving limit: the starting prevention system inhibits engine starting.

To be able to start the engine, you must call on a PEUGEOT dealer or a qualified workshop.

i Freezing of the AdBlue® additive

The AdBlue® additive freezes at temperatures below around -11°C . The SCR system includes a heater for the AdBlue® tank.

In exceptional circumstances (vehicle kept for a long period at temperatures that are constantly below -15°C), an emissions control system fault alert may be related to freezing of the AdBlue® in your vehicle.

Park your vehicle in a warmer area for a few hours until the additive becomes liquid again.

The emissions alert does not go off immediately, it will occur after several mile of running.

Snow chains

In wintry conditions, snow chains improve traction as well as the behaviour of the vehicle when braking.

i The snow chains must be fitted only to the front wheels. They must never be fitted to "space-saver" type spare wheels.

Use only the chains designed to be fitted to the type of wheel fitted to your vehicle:

| Original tyre size | Maximum link size. |
|--------------------|--------------------|
| 215/55 R16 | 9 mm |
| 215/50 R17 | |
| 215/45 R18 | |

For more information on snow chains, contact a PEUGEOT dealer or a qualified workshop.

! It is strongly recommended that before you leave, you practise fitting the snow chains on a level and dry surface.

i Take account of the legislation in force in your country on the use of snow chains and the maximum running speed authorised.

Advice on installation

- f** If you have to fit the chains during a journey, stop the vehicle on a flat surface on the side of the road.
- f** Apply the parking brake and position any wheel chocks to prevent movement of your vehicle.
- f** Fit the chains following the instructions provided by the manufacturer.
- f** Move off gently and drive for a few moments, without exceeding 30 mph (50 km/h).
- f** Stop your vehicle and check that the snow chains are correctly tightened.

i Avoid driving with snow chains on roads that have been cleared of snow, to avoid damaging your vehicle's tyres and the road surface. If your vehicle is fitted with alloy wheels, check that no part of the chain or its fixings is in contact with the wheel rim.

Changing a bulb

Front lamps

Model with halogen headlamps

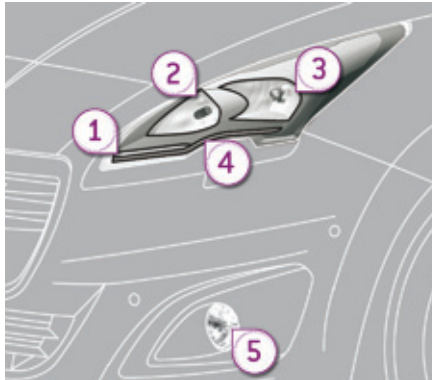

1. Direction indicators (light-emitting diodes - LEDs).
2. Main beam headlamps (HB3).
3. Dipped beam headlamps (H7).
4. Daytime running lamps/sidelamps (light-emitting diodes - LEDs).
5. Foglamps (PS24W).

Model with xenon and directional headlamps

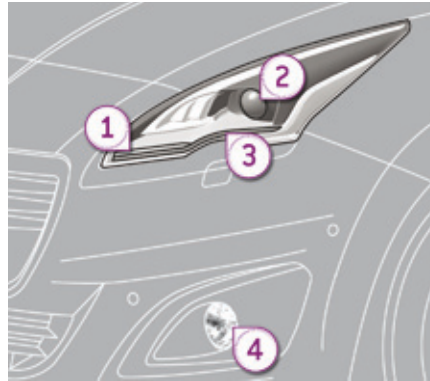

1. Direction indicators (light-emitting diodes - LEDs).
2. Dipped / main beam directional headlamps (D1S).
3. Daytime running lamps / sidelamps (light-emitting diodes - LEDs).
4. Foglamps (PS24W).

! Risk of electrocution

Xenon bulbs (D1S) must be replaced by a PEUGEOT dealer or a qualified workshop.

! The headlamps are fitted with polycarbonate glass with a protective coating:

- ☞ **do not clean them using a dry or abrasive cloth, nor with a detergent or solvent product,**
- ☞ use a sponge and soapy water or a pH neutral product,
- ☞ when using a high pressure washer on persistent marks, do not keep the lance directed towards the lamps or their edges for too long, so as not to damage their protective coating and seals.

Changing a bulb should only be done after the headlamp has been switched off for several minutes (risk of serious burns).

- ☞ Do not touch the bulb directly with your fingers, use a lint-free cloth.

It is imperative to use only anti-ultraviolet (UV) type bulbs to avoid damaging the headlamp. Always replace a failed bulb with a new bulb with the same type and specification.

Changing direction indicators and daytime running lamps / sidelamps

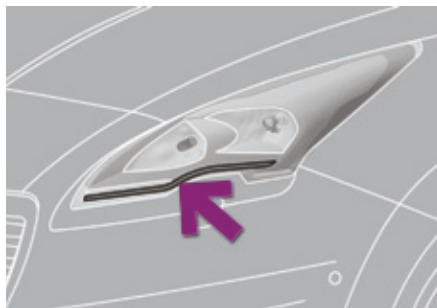

For the replacement of these LED (light-emitting diode) lamps, contact a PEUGEOT dealer or a qualified workshop.

Changing dipped beam headlamp bulbs (models with halogen headlamps)

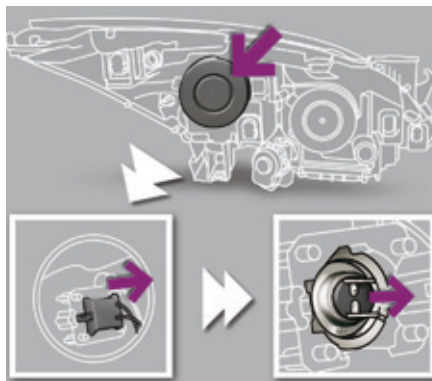

- ☞ Remove the protective plastic cover by pulling the tab.
 - ☞ Disconnect the bulb connector.
 - ☞ Extract the bulb by pulling and change it.
- To refit, carry out these operations in reverse order.

Changing main beam headlamp bulbs (halogen model)

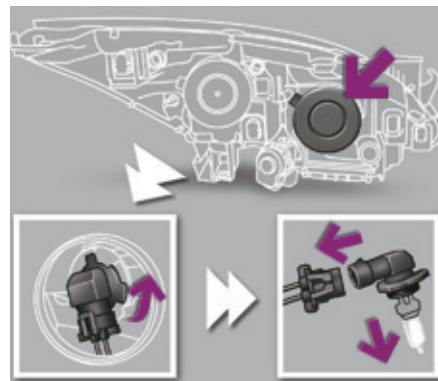

- ☞ Remove the protective plastic cover by pulling the tab.
- ☞ Without disconnecting the connector, turn the body of the bulb a quarter of a turn to the left to disengage the assembly.
- ☞ Disconnect the connector to release the bulb.

To refit, carry out these operations in reverse order.

i Changing dipped beam and main beam headlamp bulbs (models with xenon headlamps)

D1S xenon bulbs must be changed by a PEUGEOT dealer or a qualified workshop as there is a risk of electrocution.

It is recommended that all D1S bulbs are changed at the same time if one of them fails.

Changing integrated direction indicator side repeaters

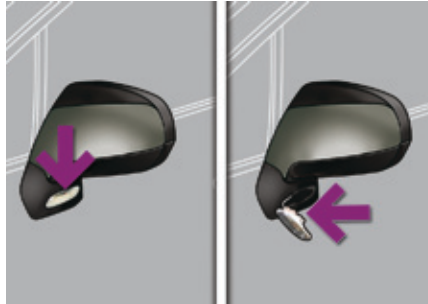

- ☞ Insert a screwdriver towards the centre of the repeater between the repeater and the base of the mirror.
- ☞ Tilt the screwdriver to extract the repeater and remove it.
- ☞ Disconnect the repeater connector.

To refit, carry out these operations in reverse order.

Contact a PEUGEOT dealer or a qualified workshop to obtain a new repeater.

i You can also contact a PEUGEOT dealer or a qualified workshop to have these lamps changed.

Changing foglamp bulbs

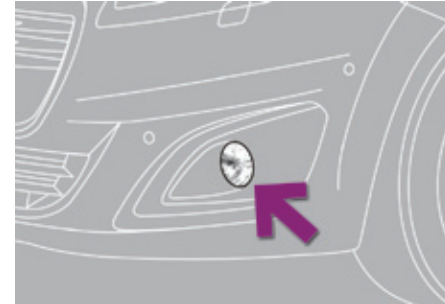

Contact a PEUGEOT dealer or a qualified workshop.

Rear lamps

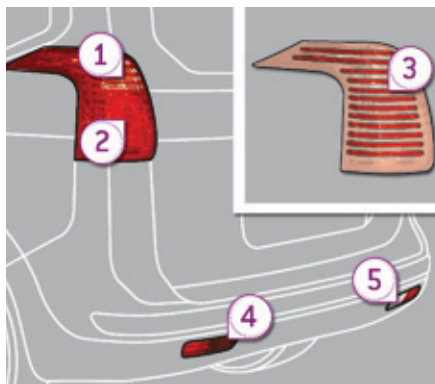

1. Direction indicators (PY21W-21W).
2. Brake lamps (P21W-21W).
3. Sidelamps (LEDs).
4. Reversing lamp (P21W).
5. Foglamp (P21W).

Changing brake lamp and direction indicator bulbs

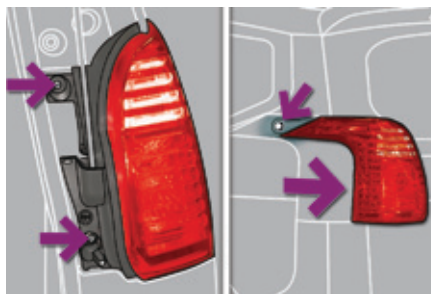

- ☞ Remove the two lamp unit fixing nuts.
- ☞ Pull the lamp rearwards (a positioning lug retains the lamp).
- ☞ Disconnect the lamp connector.

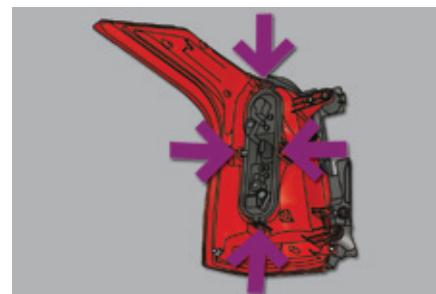

- ☞ Press the four tabs and remove the bulb holder.

Changing sidelamps (LEDs)

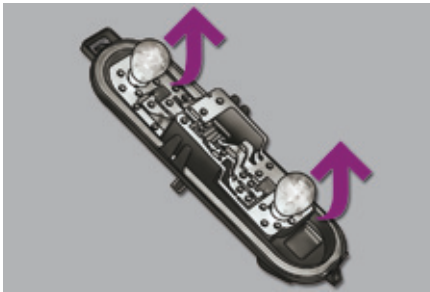

- ☞ Turn the bulb a quarter of a turn and change it.
- To refit, carry out these operations in reverse order.

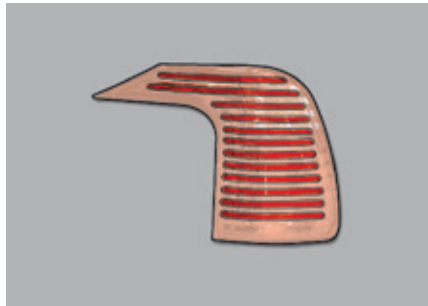

For the replacement of this type of LED lamp, contact a PEUGEOT dealer or a qualified workshop.

Changing foglamp or reversing lamp bulbs

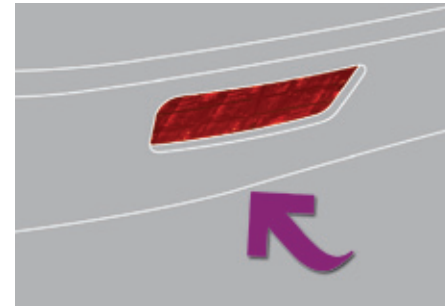

- ☞ Reach under the bumper.
- ☞ Turn the bulb a quarter of a turn and change it.

Changing the third brake lamp bulb (5W5)

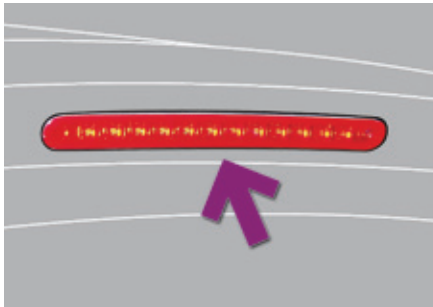

- ☞ Open the boot and remove the upper tailgate seal.
- ☞ Remove the centre tailgate trim.
- ☞ Unscrew the two nuts using a 10mm spanner.
- ☞ Press the threaded pins while supporting the lamp from the outside.
- ☞ Close the tailgate.
- ☞ Disconnect the lamp connector then the screenwash pipe to remove the lens.

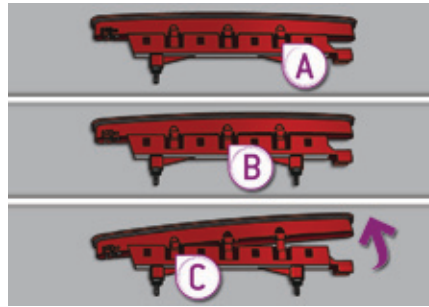

- ☞ Press the pairs of clips **A** then **B** then **C** to detach the bulb holders.

Changing the number plate lamp bulbs (W5W)

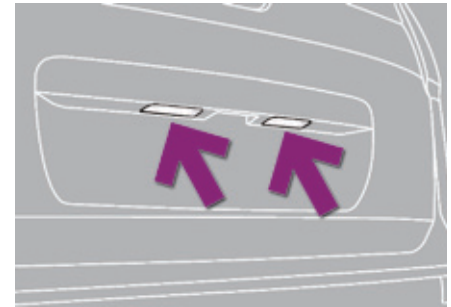

- ☞ Insert a thin screwdriver into one of the outer holes of the lens.
- ☞ Push it outwards to unclip.
- ☞ Remove the lens.
- ☞ Pull the bulb out and change it.

Changing a fuse

Procedure for replacing a faulty fuse with a new fuse to rectify a failure of the corresponding function.

Access to the tools

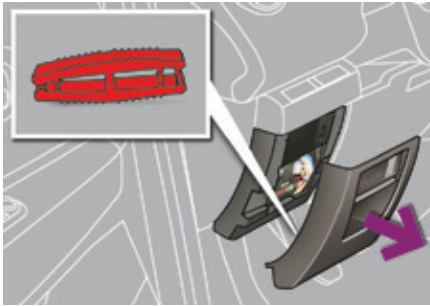

The extraction tweezers is fitted to the back of the dashboard fusebox cover.

To gain access to it:

- ☞ Remove the cover completely.
- ☞ Remove the tweezers.

Changing a fuse

Before changing a fuse, the cause of the failure must be identified and rectified.

- ☞ Identify the failed fuse by checking the condition of its filament.

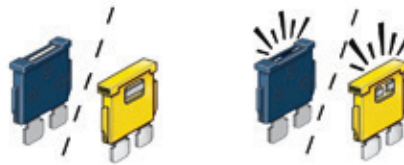

Good

Failed

- ☞ Use the special tweezers to extract the fuse from its housing.
- ☞ Always replace the faulty fuse with a fuse of the same rating.
- ☞ Check that the number marked on the fusebox, the rating marked on the fuse and the following tables all agree.

! The replacement of a fuse not mentioned in the tables below may cause a serious malfunction on your vehicle.
Contact a PEUGEOT dealer or a qualified workshop.

i Installing electrical accessories

Your vehicle's electrical system is designed to operate with standard or optional equipment.
Before installing other electrical equipment or accessories on your vehicle, contact a PEUGEOT dealer or a qualified workshop.

! PEUGEOT will not accept responsibility for the cost incurred in repairing your vehicle or for rectifying malfunctions resulting from the installation of accessories not supplied and not recommended by PEUGEOT and not installed in accordance with its instructions, in particular when the combined consumption of all of the additional equipment connected exceeds 10 milliamperes.

Dashboard fuses

The fusebox is placed in the lower dashboard.

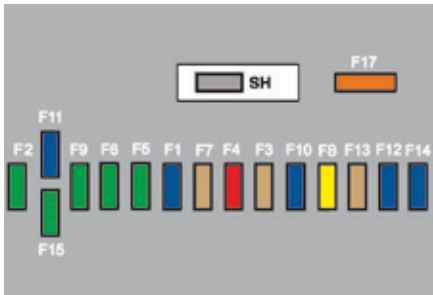

Fuse tables

| Fuse N° | Rating (A) | Functions |
|---------|------------|---|
| F1 | 15 | Rear wiper. |
| F2 | - | Not used. |
| F3 | 5 | Airbag control unit. |
| F4 | 10 | Electrochrome rear view mirror, air conditioning, switching and protection unit, rear multimedia. |
| F5 | 30 | Front one-touch electric windows. |
| F6 | 30 | Rear one-touch electric windows. |
| F7 | 5 | Front and rear courtesy lamps, map reading lamps, rear reading lamps, sun visor lighting, glove box lighting, centre armrest lighting, boot 12 V relay control. |

Access to the fuses

☞ Refer to the paragraph "Access to the tools".

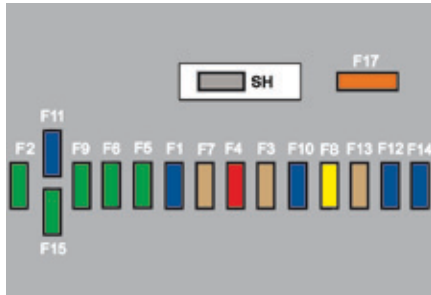

| Fuse N° | Rating (A) | Functions |
|---------|------------|--|
| F8 | 20 | Audio equipment, audio/telephone, CD changer, multifunction screen, tyre under-inflation detection, alarm siren, alarm control unit, telematic unit. |
| F9 | 30 | Front 12 V socket, cigarette lighter, rear 12 V socket. |
| F10 | 15 | Steering mounted controls. |
| F11 | 15 | Low current ignition switch. |
| F12 | 15 | Trailer presence, rain / sunshine sensor, supply for fuses F32, F34, F35. |
| F13 | 5 | Engine fusebox, airbag control unit. |
| F14 | 15 | Instrument panel, instrument panel screen, supply for fuse F33. |
| F15 | 30 | Locking and deadlocking. |
| F17 | 40 | Heated rear screen, supply for fuse F30. |

| Fuse N° | Rating (A) | Functions |
|----------------|-------------------|--|
| F30 | 5 | Heated door mirrors. |
| F31 | 30 | Boot 12 V socket. |
| F32 | 5 | Electronic gearbox gear lever. |
| F33 | 10 | Head-up display, Bluetooth system, air conditioning. |
| F34 | 5 | Seat belt warning lamp display. |
| F35 | 10 | Parking sensors, Hi-Fi amplifier authorisation. |
| F36 | 10 | Trailer fusebox control unit, driver's door control pad. |
| F37 | 20 | Hi-Fi amplifier. |
| F38 | 30 | Driver's electric seat. |
| F39 | 20 | Panoramic sunroof blind. |

Engine compartment fuses

The fusebox is placed in the engine compartment near the battery.



Access to the fuses

- ☞ Unclip the cover.
- ☞ Change the fuse (see corresponding paragraph).
- ☞ When you have finished, close the cover carefully to ensure correct sealing of the fusebox.



Fuse table

| Fuse N° | Rating (A) | Functions |
|---------|------------|--|
| F2 | 15 | Horn. |
| F3 | 10 | Front / rear wash-wipe. |
| F4 | 10 | Daytime running lamps. |
| F5 | 15 | Purge canister, turbine discharge and Turbo pressure regulation electrovalves (1.6 litre THP), oil vapour heater (1.6 litre THP), diesel heater (1.6 litre HDi). |
| F6 | 10 | Diagnostic socket, directional headlamps, particle emission filter pump (Diesel), Distance alert, mirror adjustment control. |
| F7 | 10 | Power steering control unit, automatic gearbox, directional headlamps height adjustment motor. |
| F8 | 20 | Starter motor control. |
| F9 | 10 | Clutch and brake pedal switches. |
| F11 | 40 | Air conditioning fan. |



| Fuse N° | Rating (A) | Functions |
|---------|------------|--------------------------------------|
| F12 | 30 | Windscreen wipers slow / fast speed. |
| F14 | 30 | Air pump. |
| F15 | 10 | Right-hand main beam headlamp. |
| F16 | 10 | Left-hand main beam headlamp. |
| F17 | 15 | Left-hand dipped headlamp. |
| F18 | 15 | Right-hand dipped headlamp. |

Table of fuses above the battery

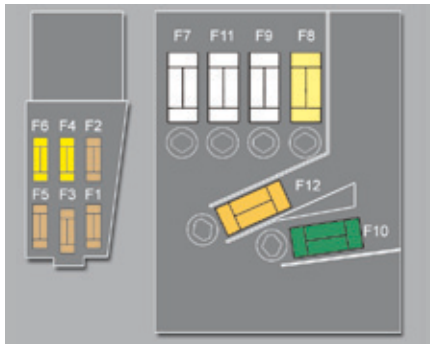

| Fuse N° | Rating (A) | Functions |
|---------|------------|---------------------------------|
| F2 | 5 | Dual function brake switch. |
| F3 | 5 | Battery charge unit. |
| F4 | 25 | ABS/DSC electrovalves. |
| F6 | 15 | Electronic / automatic gearbox. |

12 V battery

Procedure for starting the engine using another battery or charging a discharged battery.

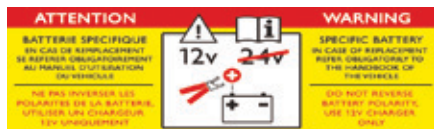

The presence of this label, in particular with the Stop & Start system, indicates the use of a 12 V lead-acid battery with special technology and specification; the involvement of a PEUGEOT dealer or a qualified workshop is essential when replacing or disconnecting the battery.

After refitting the battery, the Stop & Start system will only be active after a continuous period of immobilisation of the vehicle, a period which depends on the climatic conditions and the state of charge of the battery (up to about 8 hours).

With Stop & Start, the battery does not have to be disconnected for charging.

Access to the battery

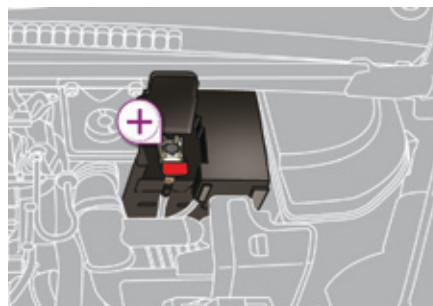

The battery is located under the bonnet. To gain access to it:

- ☞ open the bonnet using the interior release lever, then the exterior safety catch,
- ☞ secure the bonnet stay,
- ☞ remove the plastic cover on the (+) terminal,

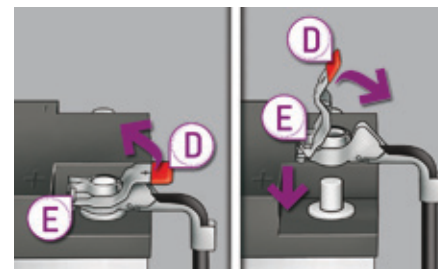

Disconnecting the (+) cable

- ☞ Raise the locking tab **D** fully to release the cable terminal clamp **E**.

Reconnecting the (+) cable

- ☞ Position the open clamp **E** of the cable on the positive post (+) of the battery.
- ☞ Press vertically on the clamp **E** to position it correctly on the battery.
- ☞ Lock the clamp by spreading the positioning lug and then lowering the tab **D**.

i Do not apply excessive force on the tab as locking will not be possible if the clamp is not positioned correctly; start the procedure again.

Starting using another battery

When your vehicle's battery is discharged, the engine can be started using a slave battery (external or on another vehicle) and jump lead cables.

i First check that the slave battery has a nominal voltage of 12 V and a capacity at least equal to that of the discharged battery.

! Do not try to start the engine by connecting a battery charger. Do not disconnect the (+) terminal when the engine is running.

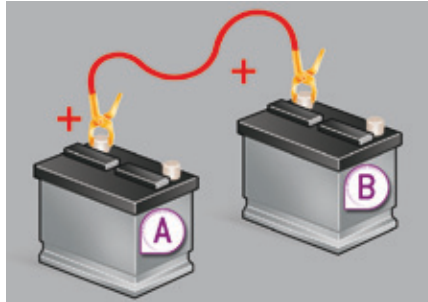

- ☞ Remove the plastic cover from the (+) terminal, if your vehicle has one.
- ☞ Connect the red cable to the positive terminal (+) of the flat battery **A**, then to the positive terminal (+) of the slave battery **B**.
- ☞ Connect one end of the green or black cable to the negative terminal (-) of the slave battery **B** (or earth point on the other vehicle).

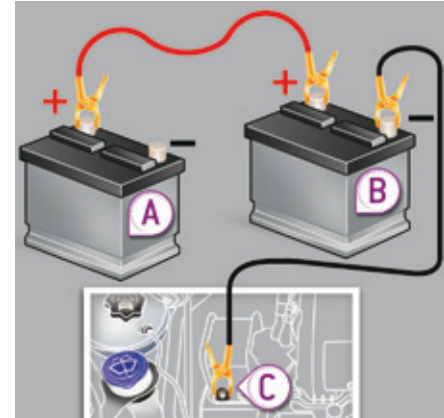

- ☞ Connect the other end of the green or black cable to the earth point **C** on the broken down vehicle (or on the engine mounting).
- ☞ Start the engine of the vehicle with the good battery and leave it running for a few minutes.
- ☞ Operate the starter on the broken down vehicle and let the engine run. If the engine does not start straight away, switch off the ignition and wait a few moments before trying again.
- ☞ Wait until the engine returns to idle then disconnect the jump lead cables in the reverse order.
- ☞ Refit the plastic cover to the (+) terminal, if your vehicle has one.

Charging the battery using a battery charger

- ☞ Disconnect the battery from the vehicle.
- ☞ Follow the instructions for use provided by the manufacturer of the charger.
- ☞ Connect the battery starting with the negative terminal (-).
- ☞ Check that the terminals and connectors are clean. If they are covered with sulphate (whitish or greenish deposit), remove them and clean them.



The batteries contain harmful substances such as sulphuric acid and lead. They must be disposed of in accordance with regulations and must not, in any circumstances, be discarded with household waste. Take used remote control batteries and vehicle batteries to a special collection point.



It is advisable to disconnect the battery if the vehicle is to be left unused for more than one month.



Protect your eyes and face before handling the battery.

All operations on the battery must be carried out in a well ventilated area and away from naked flames and sources of sparks, so as to avoid the risk of explosion or fire.

Do not try to charge a frozen battery; the battery must first be thawed out to avoid the risk of explosion. If the battery has been frozen, before charging have it checked by a PEUGEOT dealer or a qualified workshop who will check that the internal components have not been damaged and the casing is not cracked, which could cause a leak of toxic and corrosive acid.

Do not reverse the polarity and use only a 12 V charger.

Do not disconnect the terminals while the engine is running.

Do not charge the batteries without disconnecting the terminals first.

Wash your hands afterwards.

Do not push the vehicle to start the engine if you have an electronic or automatic gearbox.

Before disconnecting the battery

Wait 2 minutes after switching off the ignition before disconnecting the battery.

Close the windows and the doors before disconnecting the battery.

Following reconnection of the battery

Following reconnection of the battery, switch on the ignition and wait 1 minute before starting to permit initialisation of the electronic systems.

However, if problems remain following this operation, contact a PEUGEOT dealer or a qualified workshop.

Referring to the corresponding section, you must yourself reinitialise (depending on version):

- the remote control key,
- the electric blind(s),
- ...



Some functions are not available if the battery is not sufficiently charged.

Load reduction mode

System which manages the use of certain functions according to the level of charge remaining in the battery.

When the vehicle is being driven, the load reduction function temporarily deactivates certain functions, such as the air conditioning, the heated rear screen...

The deactivated functions are reactivated automatically as soon as conditions permit.

Energy economy mode

System which manages the duration of use of certain functions to conserve a sufficient level of charge in the battery.

After the engine has stopped, you can still use functions such as the audio and telematics system, windscreen wipers, dipped beam headlamps, courtesy lamps, etc. for a maximum combined duration of thirty minutes.

This period may be greatly reduced if the battery is not fully charged.

Switching to economy mode

Once this time has elapsed, a message appears in the screen indicating that the vehicle has switched to economy mode and the active functions are put on standby.

Exiting economy mode

These functions are reactivated automatically next time the vehicle is driven.

To restore the use of these functions immediately, start the engine and let it run for at least 5 minutes.

- i** If the telephone is being used at this time:
- it will be maintained for 5 minutes with the hands-free kit of your PEUGEOT Connect Sound or PEUGEOT Connect Navigation,
 - it will still be possible to finish the call with the PEUGEOT Connect Media.

- !** Let the engine run for the duration specified to ensure that the battery charge is sufficient. Do not repeatedly and continuously restart the engine in order to charge the battery. A flat battery prevents the engine from starting (refer to the "Battery" paragraph).

Changing a wiper blade



Before removing a front wiper blade

- ☞ Within one minute after switching off the ignition, operate the wiper stalk to position the wiper blades vertically on the windscreen.

Removing

- ☞ Raise the corresponding wiper arm.
- ☞ Unclip the wiper blade and remove it.

Fitting

- ☞ Put the corresponding new wiper blade in place and clip it.
- ☞ Fold down the wiper arm carefully.

After fitting a front wiper blade

- ☞ Switch on the ignition.
- ☞ Operate the wiper stalk again to park the wiper blades.

Towing the vehicle

Procedure for having your vehicle towed or for towing another vehicle using the removable towing eye provided in the tool kit.

Access to the tools

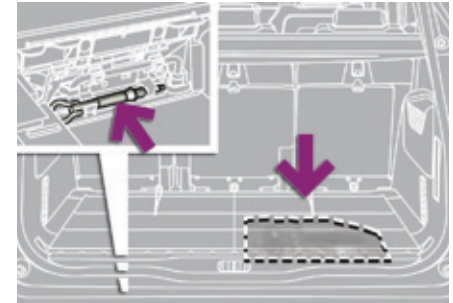

The towing eye is installed under the left-hand concertina board, in the boot interior trim.

For access to it:

- ☞ open the boot,
- ☞ raise the concertina board,
- ☞ remove the towing eye from the holder.

Towing your vehicle



- ☞ On the front bumper, unclip the cover by pressing at the bottom.
- ☞ Screw the towing eye in fully.
- ☞ Install the towing bar.
- ☞ Switch on the hazard warning lamps on the towed vehicle.

i Put the gear lever into neutral (position **N** for an electronic or automatic gearbox). Failure to follow this instruction could lead to damage to certain components (brakes, transmission, ...) and the absence of braking assistance on restarting the engine.

Towing another vehicle



- ☞ On the rear bumper, unclip the cover by pressing at the bottom.
- ☞ Screw the towing eye in fully.
- ☞ Install the towing bar.
- ☞ Switch on the hazard warning lamps on the towed vehicle.

! General recommendations

Observe the legislation in force in your country.

Ensure that the weight of the towing vehicle is higher than that of the towed vehicle.

The driver must remain at the wheel of the towed vehicle and must have a valid driving licence.

When towing a vehicle with all four wheels on the ground, always use an approved towing bar; rope and straps are prohibited.

When towing a vehicle with the engine off, there is no longer any power assistance for braking or steering.

In the following cases, you must always call on a professional recovery service:

- vehicle broken down on a motorway or fast road,
- 4 wheel drive vehicle,
- when it is not possible to put the gearbox into neutral, unlock the steering, or release the parking brake,
- towing with only two wheels on the ground,
- where there is no approved towing bar available...

Towbar with quickly detachable towball

No tools are required to install or remove the towball on this genuine towbar system.

Fitting



- ☞ Below the rear bumper, unclip and remove the protective cover on the carrier.

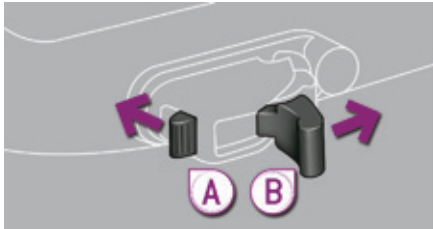

- ☞ On the towball, press and hold control **A**.
- ☞ Release the locking mechanism by pressing the trigger **B**.

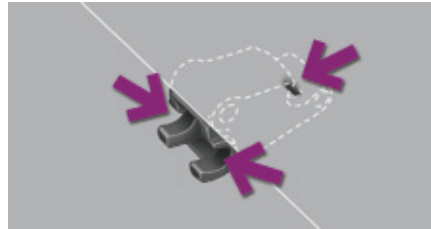

- ☞ Before fitting the towball, check that the points of contact, indicated by the arrows, are clean. Use a soft clean cloth.

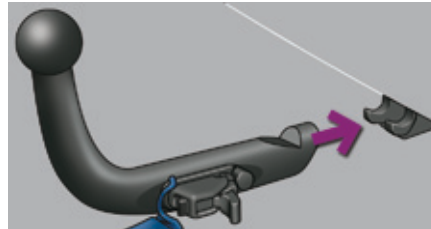

- ☞ Put the end of the towball into the carrier, located below the bumper, as far as it will go.

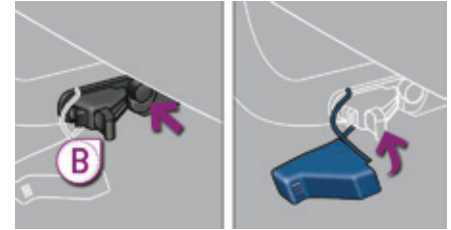

- ☞ Ensure that the towball is fully engaged. The two pins must be in contact with the cut-outs in the carrier and the trigger **B** must have returned to the "locked" position.
- ☞ Install and clip in place the protective cover, by rotating it to the left.

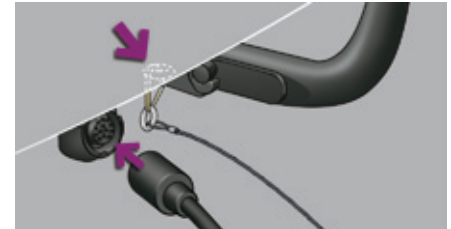

- ☞ Connect the trailer plug to the 13-way socket provided, located next to the carrier.
- ☞ Make the trailer safe by attaching its safety cable to the eye provided for this purpose, located on the carrier.

Removing

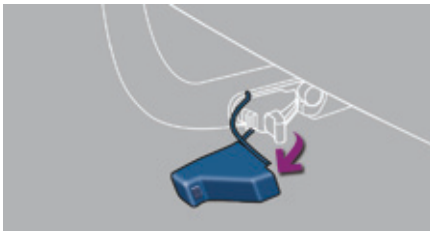

- ☞ Unclip and remove the protective cover, by turning it to the right.

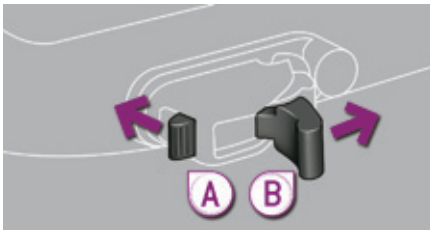

- ☞ On the towball, press and hold control **A**.
- ☞ Release the locking mechanism by pressing the trigger **B**.

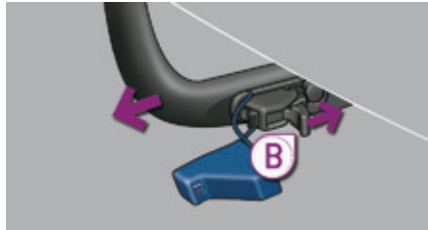

- ☞ Press the trigger **B** and remove the towball by pulling it towards you.

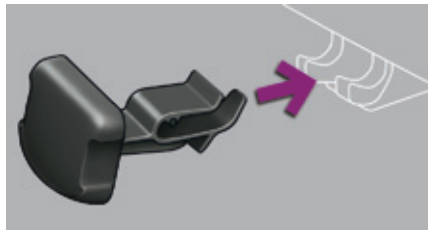

- ☞ Clip the protective cover in place on the carrier located below the bumper.

- i** When the towball is installed, it may interfere with the complete opening of the lower tailgate. Take care to avoid the tailgate coming into contact with the towball.

- !** If the towball is not locked in place, the trailer could separate. There is a risk of an accident. Always lock the towball in the way described.

Observe the legislation in force in the country in which you are driving. Remove the towball when it is not being used.

Before setting off, check that the trailer lighting and signalling works correctly.

Maximum authorised nose weight: 70 kg.

Refer to the "Technical data" section for the maximum weights and towed loads for your vehicle.

Carrying system (box or bicycle carrier). You must not exceed the maximum nose weight on the towbar: if this weight is exceeded, the device could detach from the vehicle and cause a serious accident.

Towing a trailer



Your vehicle is primarily designed for transporting people and luggage, but it may also be used for towing a trailer.

! If the trailer starts to sway, you risk losing control. The trailer could overturn. There is a risk of an accident. Do not try to correct the trailer's movement by accelerating. Reduce your speed and do not counter-steer. Brake if necessary.

i We recommend the use of genuine PEUGEOT towbars and their harnesses that have been tested and approved from the design stage of your vehicle, and that the fitting of the towbar is entrusted to a PEUGEOT dealer or a qualified workshop. If the towbar is not fitted by a PEUGEOT dealer, it is imperative that it is fitted in accordance with the vehicle manufacturer's instructions.

! Driving with a trailer places greater demands on the towing vehicle and the driver must take particular care.

Driving advice

Distribution of loads

☞ Distribute the load in the trailer so that the heaviest items are as close as possible to the axle and the nose weight approaches the maximum permitted without exceeding it.

Air density decreases with altitude, thus reducing engine performance. Above 1 000 metres, the maximum towed load must be reduced by 10 % for every 1 000 metres of altitude.

i Refer to the "Technical data" section for details of the weights and towed loads which apply to your vehicle.

Side wind

- ☞ Take into account the increased sensitivity to side wind.

Cooling

Towing a trailer on a slope increases the temperature of the coolant.

As the fan is electrically controlled, its cooling capacity is not dependent on the engine speed.

- ☞ To lower the engine speed, reduce your speed.

The maximum towed load on a long incline depends on the gradient and the ambient temperature.

In all cases, keep a check on the coolant temperature.



- ☞ If the warning lamp and the **STOP** warning lamp come on, stop the vehicle and switch off the engine as soon as possible.

Braking

Towing a trailer increases the braking distance. To avoid overheating of the brakes on a long mountain type of descent, the use of engine braking is recommended.

Tyres

- ☞ Check the tyre pressures of the towing vehicle and of the trailer, observing the recommended pressures.

Lighting

- ☞ Check the electrical lighting and signalling on the trailer.

i The rear parking sensors will be deactivated automatically if a genuine PEUGEOT towbar is used.

Fitting roof bars

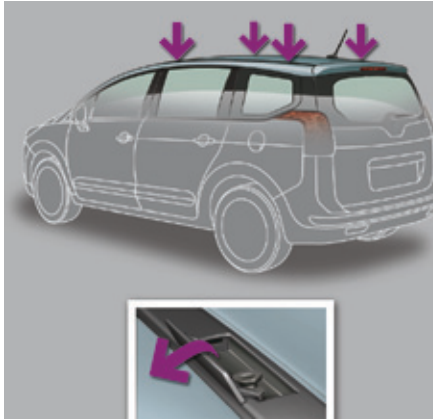

When fitting transverse roof bars, use the four quick-fit fixings provided for this purpose:

- ☞ lift the concealing flaps,
- ☞ open the fixing covers on each bar using the key,
- ☞ put each fixing in place and lock them on the roof one by one,
- ☞ ensure that roof bars are correctly fitted (by shaking them),
- ☞ close the fixing covers on each bar using the key.

i Maximum authorised weight on the roof bars, for a loading height not exceeding 40 cm (with the exception of bicycle carriers): **65 kg**.
If the height exceeds 40 cm, adapt the speed of the vehicle to the profile of the road to avoid damaging the roof bars and the fixings on the roof.
Be sure to refer to national legislation in order to comply with the regulations for transporting objects that are longer than the vehicle.



! If your vehicle is fitted with roof finishers, do not use them for carrying loads.

Very cold climate screen

Removable protective screen which prevents the accumulation of snow at the radiator cooling fan.

Before fitting or removing the screen, ensure that the engine is off and the cooling fan has stopped. It is recommended that the screen be fitted and removed by a PEUGEOT dealer or a qualified workshop.

Fitting

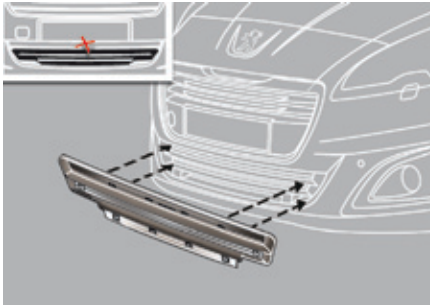

- ☞ Offer up the screen, placing the lower clips in contact with lower section of the lower grille, using the centre guide as an aid.
- ☞ Clip first the lower part, then the upper part, from the middle out towards the edges.

Removal



- ☞ Unclip the upper part of the screen, starting at the edges.
- ☞ Take the screen by the lower edges and detach it by pulling it towards you.

- i** Do not forget to remove the very cold climate screen:
- when the ambient temperature exceeds 10° C,
 - when towing,
 - at speeds above 75 mph (120 km/h).

10

Dimensions (in mm)

