

# HANDBOOK



PEUGEOT 308



# On-line handbook

Select one of the following means of access to view your handbook on-line...

Find your handbook on the PEUGEOT website, under "MyPEUGEOT".

This personal space offers advice and other useful information for the care and maintenance of your vehicle.

Scan this code for direct access to your handbook.



 If the "MyPEUGEOT" function is not available on the PEUGEOT public website for your country, you can find your handbook at the following address:

<http://public.servicebox.peugeot.com/ddb/>

Select:

- > the language,
- > the vehicle, its body style,
- > the print edition of your handbook appropriate for the date of registration of your vehicle.

Referring to the handbook on-line also gives you access to the latest information available, easily identified by the bookmark, associated with this symbol:





# Welcome

This handbook describes all of the equipment available in the whole range.

Your vehicle will be fitted with some of the equipment described in this document, depending on its trim level, version and the specification for the country in which it is sold.

The descriptions and illustrations are given without any obligation. Automobiles PEUGEOT reserves the right to modify the technical specifications, equipment and accessories without having to update this edition of the handbook.

This document is an integral part of your vehicle. It should be passed on to the new user in the event of sale or transfer.

Thank you for choosing a 308.

This handbook has been designed to enable you to make the most of your vehicle in all situations.

## Key

 safety warning

 additional information

 contributes to the protection of the environment

---

Overview ■

---

Eco-driving ■

---

Instruments 1

|                             |    |
|-----------------------------|----|
| Instrument panel            | 12 |
| Indicator and warning lamps | 13 |
| Gauges and indicators       | 28 |
| Distance recorders          | 35 |
| Trip computer               | 37 |
| Touch screen                | 40 |
| Setting the date and time   | 47 |

---

Access 2

|  |    |
|--|----|
| Remote control key                               | 50 |
| "Keyless Entry and Starting" with remote control | 56 |
| "Keyless Entry and Starting"                     | 58 |
| Boot   | 61 |
| Alarm  | 67 |
| Electric windows                                 | 70 |

---

Ease of use and comfort 3

|   |     |
|---|-----|
| PEUGEOT i-Cockpit                                 | 72  |
| Steering wheel adjustment                         | 72  |
| Front seats                                       | 73  |
| Rear seats (hatchback)                            | 79  |
| Rear seats (SW)                                   | 80  |
| Interior fittings                                 | 82  |
| Front armrest                                     | 84  |
| Boot fittings (hatchback)                         | 87  |
| Boot fittings (SW)                                | 88  |
| Heating and Ventilation                           | 91  |
| Manual air conditioning                           | 93  |
| Manual air conditioning (Touch screen)            | 94  |
| Dual-zone digital air conditioning (Touch screen) | 95  |
| Front demist - defrost                            | 100 |
| Rear screen demist - defrost                      | 101 |
| Panoramic sunroof                                 | 102 |
| Courtesy lamps                                    | 103 |
| Interior mood lighting                            | 104 |

---

Lighting and visibility 4

|                                     |     |
|-------------------------------------|-----|
| Mirrors                             | 105 |
| Lighting control stalk              | 107 |
| Daytime running lamps               | 110 |
| Automatic illumination of headlamps | 111 |
| Direction indicators                | 112 |
| Side spotlamps                      | 113 |
| Headlamp beam height adjustment     | 113 |
| Wiper control stalk                 | 114 |
| Automatic rain sensitive wipers     | 116 |

---

Safety 5

|   |     |
|---|-----|
| Hazard warning lamps                    | 118 |
| Appel d'urgence ou d'assistance         | 119 |
| Emergency or assistance                 | 119 |
| Horn                                    | 121 |
| Electronic stability control (ESC)      | 121 |
| Seat belts                              | 124 |
| Airbags                                 | 127 |
| Carrying children                       | 131 |
| Deactivating the passenger front airbag | 134 |
| ISOFIX mountings and child seats        | 140 |
| Child lock                              | 144 |



# Exterior

|   |              |
|---|--------------|
| Keyless Entry and Starting remote control | 56-60, 63-65 |
| Remote control key                        | 50-55, 65    |
| Starting                                  | 148-154      |

|                        |          |
|------------------------|----------|
| Wipers                 | 114-117  |
| Changing a wiper blade | 117, 222 |

|                               |         |
|-------------------------------|---------|
| Boot                          | 61-62   |
| - opening / closing           |         |
| - emergency release           |         |
| Temporary puncture repair kit | 239-245 |
| Warning triangle              | 238     |

|                  |          |
|------------------|----------|
| Parking sensors  | 198-199  |
| Reversing camera | 200      |
| Towbar           | 147, 218 |
| Towing           | 272-273  |
| Park Assist      | 201-208  |

|                              |         |
|------------------------------|---------|
| Changing bulbs               | 257-261 |
| - rear lamps                 |         |
| - 3 <sup>rd</sup> brake lamp |         |
| - number plate lamps         |         |
| - foglamp                    |         |



|                            |         |
|----------------------------|---------|
| Panoramic sunroof          | 102     |
| Bicycle carrier, roof bars | 222-223 |
| Accessories                | 220-221 |



|                               |         |
|-------------------------------|---------|
| Fuel tank, misfuel prevention | 213-215 |
|-------------------------------|---------|

|                                |       |
|--------------------------------|-------|
| Electric windows, deactivation | 70-71 |
|--------------------------------|-------|

|                    |          |
|--------------------|----------|
| Door mirrors       | 105, 113 |
| Blind spot sensors | 195-197  |

|                                   |         |
|-----------------------------------|---------|
| Lighting                          | 107-113 |
| Daytime running lamps (LEDs)      | 110     |
| Headlamp beam adjustment          | 113     |
| Changing bulbs                    | 252-256 |
| - front lamps                     |         |
| - foglamps                        |         |
| - direction indicator repeaters   |         |
| Very cold climate screen          | 217     |
| Heated windscreen and washer jets | 117     |

|                            |           |
|----------------------------|-----------|
| Keyless Entry and Starting | 56-60     |
| Doors                      | 50-52, 54 |
| - opening / closing        |           |
| - central locking          |           |
| - emergency control        |           |
| Alarm                      | 67-69     |

|                                    |               |
|------------------------------------|---------------|
| Electronic stability control (ESC) | 121-123       |
| Snow chains                        | 216           |
| Tyre pressures                     | 245, 251, 292 |
| Under-inflation detection          | 209-212       |
| Spare wheel                        | 246-251       |
| - tools                            |               |
| - removing / refitting             |               |
| Emergency collision braking        | 190-194       |

# Interior

## Hatchback

|                    |         |
|--------------------|---------|
| Child seats        | 131-145 |
| ISOFIX child seats | 140-144 |
| Manual child lock  | 144     |

|                        |    |
|------------------------|----|
| Rear seats             | 79 |
| Rear armrest, ski flap | 86 |

|                  |         |
|------------------|---------|
| Boot fittings    | 87      |
| Warning triangle | 238     |
| AdBlue tank      | 233-237 |

|            |         |
|------------|---------|
| Seat belts | 124-126 |
|------------|---------|

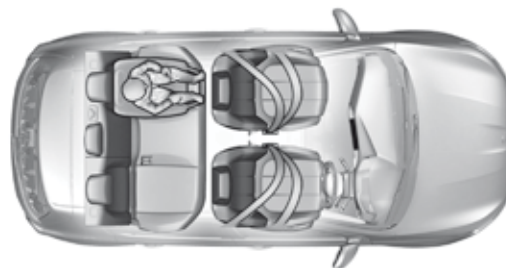

|   |          |
|---|----------|
| Interior fittings                         | 82-85    |
| - mats                                    |          |
| - front armrest                           |          |
| - 12 V accessory socket                   |          |
| - USB port / Auxiliary socket             |          |
| Deactivating the passenger's front airbag | 128, 134 |

|                              |         |
|------------------------------|---------|
| Airbags                      | 127-130 |
| Adjusting the steering wheel | 72      |

|                              |       |
|------------------------------|-------|
| Front seats                  | 73-78 |
| - manual adjustments         |       |
| - head restraints            |       |
| - heated seats               |       |
| - electric lumbar adjustment |       |
| - massage                    |       |
| PEUGEOT i-Cockpit            | 72    |





# Instruments and controls

|                          |         |   |         |  |   |
|--------------------------|---------|---|---------|--|---|
|                          |         | Courtesy lamps                                  | 103     |  |   |
|                          |         | Interior mood lighting, footwell lighting       | 104     |  | Touch screen                              |
|                          |         | Rear view mirror                                | 106     |  | 40-46, 295-357                            |
|                          |         | PEUGEOT Connect SOS, PEUGEOT Connect Assistance | 119-120 |  |   |
|                          |         |   |         |  | PEUGEOT Connect Sound (RD5)               |
|                          |         |   |         |  | 359-378                                   |
| Dashboard fuses          | 262-265 |   |         |  |   |
|                          |         |   |         |  | Setting the date and time                 |
|                          |         |   |         |  | 47-49                                     |
| Opening the bonnet       | 225     |   |         |  |   |
|                          |         |   |         |  | Manual air conditioning                   |
|                          |         |   |         |  | 93  |
|                          |         |   |         |  | Manual air conditioning (Touch screen)    |
|                          |         |   |         |  | 94-95                                     |
|                          |         |   |         |  | Dual-zone air conditioning (Touch screen) |
|                          |         |   |         |  | 95-98                                     |
|                          |         |   |         |  | Air intake / Air recirculation            |
|                          |         |   |         |  | 99  |
|                          |         |   |         |  | Front demist / defrost                    |
|                          |         |   |         |  | 100                                       |
|                          |         |   |         |  | Rear screen demist / defrost              |
|                          |         |   |         |  | 101                                       |
| 5/6-speed manual gearbox | 163     |   |         |  |   |
| Gear shift indicator     | 164     |   |         |  |   |
| Automatic gearbox        | 165-168 |   |         |  |   |
| Dynamic function         | 169     |   |         |  |   |
| Stop & Start             | 170-172 |   |         |  |   |
| Hill start assist        | 162     |   |         |  |   |
|                          |         | Manual parking brake                            | 154     |  |   |
|                          |         | Electric parking brake                          | 155-161 |  |   |
|                          |         |   |         |  | USB port / Auxiliary socket               |
|                          |         |   |         |  | 85, 312, 366 / 367                        |



## Instruments and controls (cont.)

|   |         |
|---|---------|
| Trip computer   | 37, 39  |
| Trip computer (Touch screen)                                    | 38, 39  |
| Setting the date/time (Touch screen)                            | 47      |
| Setting the date/time (screens C, A,<br>A without audio system) | 48-49   |
| Reversing camera  | 200     |
| Display of inter-vehicle time                                   | 187-189 |
| Collision risk alert  | 190-194 |
| Emergency collision braking                                     | 193-194 |

|                      |         |
|----------------------|---------|
| Lighting             | 107-113 |
| Direction indicators | 112     |

|                               |     |
|-------------------------------|-----|
| Hazard warning lamps          | 118 |
| Locking/unlocking from inside | 66  |

|                        |         |
|------------------------|---------|
| Memorising speeds      | 173     |
| Speed limiter          | 174-176 |
| Cruise control         | 177-179 |
| Dynamic cruise control | 180-186 |



|                           |     |
|---------------------------|-----|
| Steering wheel adjustment | 72  |
| Horn                      | 121 |

|                      |       |
|----------------------|-------|
| Instrument panel     | 12-13 |
| Warning lamps        | 13-27 |
| Indicators           | 28-35 |
| Gear shift indicator | 164   |
| PEUGEOT i-Cockpit    | 72    |

|               |         |
|---------------|---------|
| Wipers        | 114-117 |
| Trip computer | 37-39   |

|                          |     |
|--------------------------|-----|
| Headlamp beam adjustment | 113 |
|--------------------------|-----|

|                                   |         |
|-----------------------------------|---------|
| Stop & Start                      | 170-172 |
| Alarm                             | 67-69   |
| Heated windscreen and washer jets | 117     |

# Maintenance - Technical data

Checking levels 228-230

- oil
- brake fluid
- coolant
- screenwash, headlamp wash fluid
- additive (Diesel with particle filter)

Checking components 231-232

- battery
- air filter / passenger compartment filter
- oil filter
- particle filter (Diesel)
- brake pads / discs

Changing bulbs 252-261

- front
- rear

Running out of fuel, Diesel (priming pump) 274

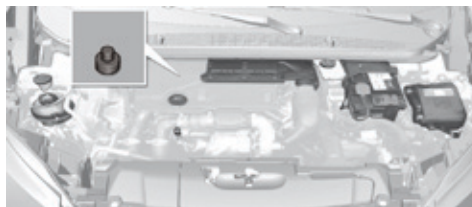

12 V battery 268-271

Load reduction, economy mode 219

Engine compartment fuses 262, 266-267

Petrol weights 278-280

Diesel weights 285-288



Dimensions 289-291

Identification markings 292

Opening the bonnet 225

Under the bonnet, petrol 226

Under the bonnet, Diesel 227

Petrol engines 275-277

Diesel engines 281-284

AdBlue 233-237

## Eco-driving

Eco-driving is a range of everyday practices that allow the motorist to optimise their fuel consumption and CO<sub>2</sub> emissions.

### Optimise the use of your gearbox

With a manual gearbox, move off gently and change up without waiting. During acceleration change up early.

With an automatic or electronic gearbox, give preference to automatic mode and avoid pressing the accelerator pedal heavily or suddenly.

The gear shift indicator invites you to engage the most suitable gear: as soon as the indication is displayed in the instrument panel, follow it straight away.

For vehicles fitted with an electronic or automatic gearbox, this indicator appears only in manual mode.

### Drive smoothly

Maintain a safe distance between vehicles, use engine braking rather than the brake pedal, and press the accelerator progressively. These practices contribute towards a reduction in fuel consumption and CO<sub>2</sub> emissions and also help to reduce the background traffic noise.

If your vehicle has cruise control, make use of the system at speeds above 25 mph (40 km/h) when the traffic is flowing well.

### Control the use of your electrical equipment

Before moving off, if the passenger compartment is too warm, ventilate it by opening the windows and air vents before using the air conditioning. Above 30 mph (50 km/h), close the windows and leave the air vents open.

Remember to make use of equipment that can help keep the temperature in the passenger compartment down (sunroof and window blinds...).

Switch off the air conditioning, unless it has automatic regulation, as soon as the desired temperature is attained.

Switch off the demisting and defrosting controls, if not automatic. Switch off the heated seat as soon as possible.

Switch off the headlamps and front foglamps when the level of light does not require their use.

Avoid running the engine before moving off, particularly in winter; your vehicle will warm up much faster while driving.

As a passenger, if you avoid connecting your multimedia devices (film, music, video game...), you will contribute towards limiting the consumption of electrical energy, and so of fuel.

Disconnect your portable devices before leaving the vehicle.

## Limit the causes of excess consumption

Spread loads throughout the vehicle; place the heaviest items in the bottom of the boot, as close as possible to the rear seats.  
Limit the loads carried in the vehicle and reduce wind resistance (roof bars, roof rack, bicycle carrier, trailer...). Use a roof box in preference. Remove roof bars and roof racks after use.

At the end of winter, remove snow tyres and refit your summer tyres.

## Observe the recommendations on maintenance

Check the tyre pressures regularly, when cold, referring to the label in the door aperture, driver's side.

Carry out this check in particular:

- before a long journey,
- at each change of season,
- after a long period out of use.

Don't forget the spare wheel and the tyres on any trailer or caravan.

Have your vehicle serviced regularly (engine oil, oil filter, air filter, passenger compartment filter...) and observe the schedule of operations recommended in the manufacturer's service schedule.

With a BlueHDi Diesel engine, if the SCR system is faulty your vehicle becomes polluting; go to a PEUGEOT dealer or a qualified workshop without delay to have the emissions of nitrogen oxides brought back to the legal level.

When refuelling, do not continue after the third cut-off of the nozzle to avoid any overflow.

At the wheel of your new vehicle, it is only after the first 1 800 miles (3 000 kilometres) that you will see the fuel consumption settle down to a consistent average.

# Instrument panel

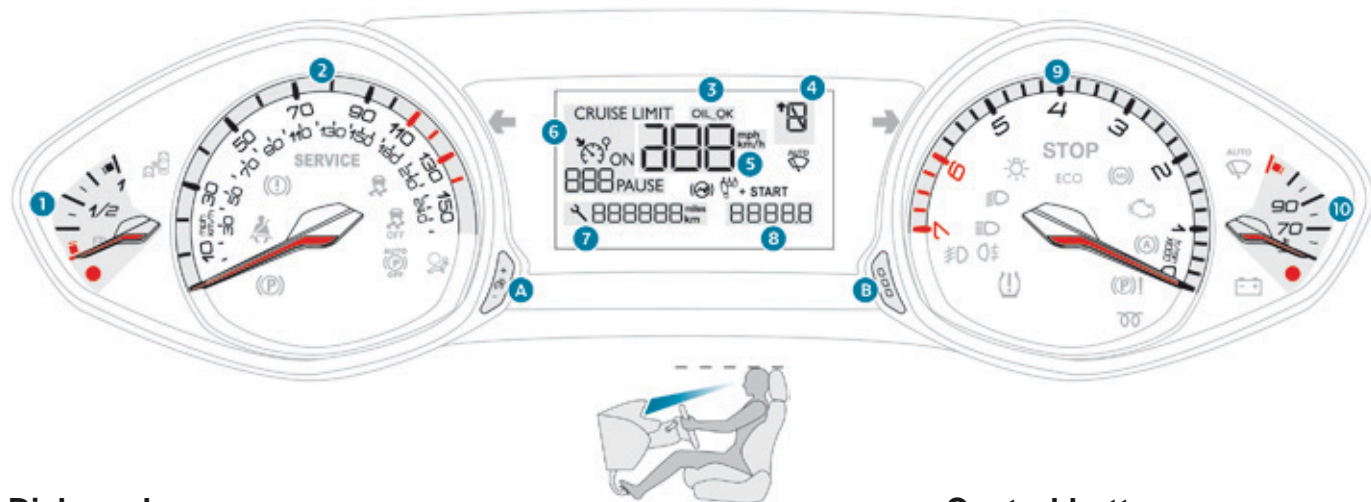

## Dials and screens

1. Fuel gauge.
2. Analogue speedometer (mph or km/h).
3. Engine oil level indicator.
4. Gear shift indicator.  
Gear with an automatic gearbox.
5. Digital speedometer (mph or km/h).
6. Cruise control or speed limiter settings.

7. Service indicator, then total distance recorder (miles or km).  
These functions are displayed in turn when the ignition is switched on.
8. Trip distance recorder (miles or km).
9. Rev counter (x 1 000 rpm or tr/min), graduation according to engine (petrol or Diesel).
10. Engine coolant temperature gauge.

## Control buttons

- A. Main lighting dimmer.
- B. Reset the trip distance recorder.  
Instantaneous information on:
  - servicing,
  - remaining driving range with the emissions additive.

## Indicator and warning lamps

Visual indicators informing the driver that a system is in operation or is switched off (indicator lamp), or has a fault (warning lamp).

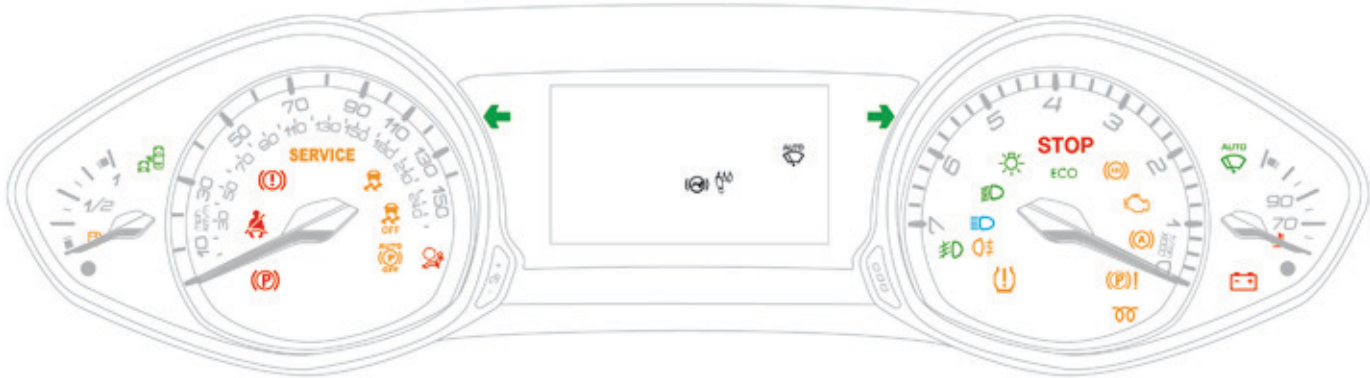

### When the ignition is switched on

Certain warning lamps come on for a few seconds in the instrument panel when the vehicle's ignition is switched on.

When the engine is started, these same warning lamps should go off.

If they remain on, before moving off, refer to the information on the warning lamp concerned.

### Associated warnings

The switching on of certain warning lamps may be accompanied by an audible signal and a message.

The warning lamps may come on continuously (fixed) or flash.







**!** Certain warning lamps may come on in one of two modes: fixed (continuous) or flashing.

Only by relating the type of illumination to the operation of the vehicle can it be determined whether the situation is normal or a fault has occurred. In the event of a fault, the illumination of the warning lamp may be accompanied by a message.

Refer to the tables in the following pages for more information.

## Operation indicator lamps



If one of the following indicator lamps comes on in the instrument panel and/or instrument panel screen, this confirms that the corresponding system has come into operation.





| Warning / indicator lamp  |                                | State                 | Cause  | Action / Observations  |
|---|--------------------------------|-----------------------|--|--|
|  | Left-hand direction indicator  | flashing with buzzer. | The lighting stalk has been pushed down.                       |  |
|  | Right-hand direction indicator | flashing with buzzer. | The lighting stalk has been pushed up.                         |  |
|  | Sidelamps                      | fixed.                | The lighting stalk is in the "Sidelamps" position.             |  |
|  | Dipped beam headlamps          | fixed.                | The lighting stalk is in the "Dipped beam headlamps" position. |  |
|  | Main beam headlamps            | fixed.                | The lighting stalk has been pulled towards you.                | Pull the stalk to return to dipped beam headlamps.                           |
|  | Front foglamps                 | fixed.                | The front foglamps are switched on.                            | Turn the ring on the stalk rearwards twice to switch off the front foglamps. |



For more information on the **Lighting control stalk**, refer to the corresponding section.





| Warning / indicator lamp  |                           | State  | Cause   | Action / Observations  |
|---|---------------------------|--------|---|--|
|  | Rear foglamps             | fixed. | The rear foglamps are on.   | Turn the ring on the stalk rearward to switch off the rear foglamps.   |
|  | Diesel engine pre-heating | fixed. | The ignition switch is at the 2 <sup>nd</sup> position (ignition on) or the "START/STOP" button has been pressed. | <p>Wait until the warning lamp goes off before starting. Once it goes off, starting is immediate, on condition that:</p> <ul style="list-style-type: none"> <li>- the clutch pedal is pressed fully down with a manual gearbox,</li> <li>- pressure is maintained on the brake pedal with an automatic gearbox.</li> </ul> <p>The period of illumination of the warning lamp is determined by the ambient conditions (up to about thirty seconds in extreme conditions).<br/>If the engine does not start, switch the ignition off and then on, wait until the warning lamp goes off again, then start the engine.</p> |
|  | Parking brake             | fixed. | The parking brake is applied or not fully released.   | <p>To switch off the warning lamp: with your foot on the brake pedal, release the parking brake.<br/>If your vehicle has an electric parking brake: with your foot on the brake pedal, push the brake control lever. Observe the safety recommendations.<br/>For more information on the <b>Manual parking brake</b> and the <b>Electric parking brake</b>, refer to the corresponding section.</p>  |

| Warning / indicator lamp  |   | State                                     | Cause   | Action / Observations   |
|---|---|---|---|---|
|  | <b>Automatic wiping</b>                                       | fixed.                                    | The wiper control has been pushed down.   | Automatic front wiping is activated.<br>To deactivate automatic wiping, operate the control stalk downwards or put the stalk into another position.   |
|  | <b>Passenger's airbag system</b>                              | fixed.                                    | The control switch, located at the passenger's end of the dashboard, is at the "ON" position.<br>The passenger's front airbag is activated.<br>In this case, do not install a rearward facing child seat on the front passenger seat. | Turn the control switch to the "OFF" position to deactivate the passenger's front airbag.<br>You can install a rearward facing child seat, unless there is a fault with the airbags (airbag warning lamp on). |
|  | <b>Stop &amp; Start</b>                                       | fixed.                                    | When the vehicle stops (red lights, traffic jams, ...) the Stop & Start system has put the engine into STOP mode.   | The warning lamp goes off and the engine restarts automatically in START mode, as soon as you want to move off.   |
|   |   | flashes for a few seconds, then goes off. | STOP mode is temporarily unavailable,<br>or<br>START mode is invoked automatically.   | For more information on <b>Stop &amp; Start</b> , refer to the corresponding section.   |
|  | <b>Blind spot monitoring system</b><br>(depending on version) | fixed.                                    | The blind spot monitoring system has been activated.  | For more information on the <b>Blind spot monitoring system</b> , refer to the corresponding section.   |

## Deactivation indicator lamps

If one of the following indicator lamps comes on, this confirms that the corresponding system has been switched off intentionally. This is may be accompanied by an audible signal and the display of a message.

| Warning / indicator lamp  | State   | Cause   | Action / Observations  |
|---|---|---|--|
|  <p><b>Passenger's front airbag</b></p>            | <p>fixed in the seat belt and front passenger's airbag warning lamps display.</p> | <p>The control switch, located at the passenger's end of the dashboard, is set to the "OFF" position.<br/>The passenger's front airbag is deactivated.<br/>You can install a rearward facing child seat, unless there is a fault with the airbags (airbag warning lamp on).</p> | <p>Turn the control switch to the "ON" position to activate the passenger's front airbag; in this case, you must not install a child seat in the rearward facing position on this seat.</p>  |
|  <p><b>Dynamic stability control (DSC/ASR)</b></p> | <p>fixed.</p>   | <p>The button is pressed and the indicator lamp comes on.<br/>The DSC/ASR is deactivated.<br/>DSC: dynamic stability control.<br/>ASR: anti-slip regulation.</p>  | <p>Press the button to activate the DSC/ASR. Its indicator lamp goes off.<br/>The DSC/ASR system is activated automatically when the vehicle is started.<br/>If deactivated, the system is reactivated automatically from around 30 mph (50 km/h).<br/>For more information on the <b>Electronic stability programme (ESC)</b> and in particular, DSC/ASR, refer to the corresponding section.</p> |

## Warning lamps



When the engine is running or the vehicle is being driven, illumination of one of the following warning lamps indicates a fault which requires action on the part of the driver.





Any fault resulting in the illumination of a warning lamp must be investigated further using the associated message.



If you encounter any problems, contact a PEUGEOT dealer or a qualified workshop.

| Warning / indicator lamp |             | State  | Cause  | Action / Observations   |
|--------------------------|-------------|--|--|---|
| <b>STOP</b>              | <b>STOP</b> | fixed, associated with another warning lamp, accompanied by an audible signal and a message. | Illumination of this warning lamp is related to a serious fault detected with the engine, the braking system, the power steering, etc., or a major electrical fault. | You must stop as soon as it is safe to do so.<br>Park, switch off the ignition and call a PEUGEOT dealer or a qualified workshop. |



| Warning / indicator lamp  |                | State  | Cause   | Action / Observations   |
|---|----------------|--|---|---|
| <b>SERVICE</b>  | <b>Service</b> | on temporarily.  | A minor fault has occurred for which there is no specific warning lamp. | Identify the cause of fault by means of the message displayed in the screen.<br>You can deal with some faults or anomalies yourself, such as an open door, or the start of saturation of the particle filter (as soon as the traffic conditions permit, regenerate the filter by driving at a speed of at least 37 mph (60 km/h), until the warning lamp goes off).<br>For other faults, such as a failure of the under-inflation detection system, contact a PEUGEOT dealer or a qualified workshop. |
|   |                | fixed.   | A major fault has occurred for which there is no specific warning lamp. | Identify the fault by reading the message displayed; you must contact a PEUGEOT dealer or a qualified workshop.   |
|  |                | fixed, associated with flashing and then fixed display of the service spanner. | The servicing interval has been exceeded.                               | Only on BlueHDi Diesel versions.<br>Your vehicle must be serviced as soon as possible.  |

| Warning / indicator lamp  |  | State     | Cause   | Action / Observations   |
|---|--|-----------|---|---|
|  | <b>Electric parking brake</b>  | flashing. | The electric parking brake is not applied automatically.<br>The application/release is faulty.  | You must stop as soon as it is safe to do so.<br>Park on flat level ground, engage a gear (or place the lever in position <b>P</b> for an automatic gearbox), switch off the ignition and contact a PEUGEOT dealer or a qualified workshop.   |
|  | <b>Electric parking brake fault</b>  | fixed.    | The electric parking brake has a fault.   | Contact a PEUGEOT dealer or a qualified workshop without delay.<br>For more information on the <b>Electric parking brake</b> , refer to the corresponding section.  |
|  | <b>Deactivation of the automatic functions of the electric parking brake</b> | fixed.    | The "automatic application" (on switching off the engine) and "automatic release" functions are deactivated or faulty.<br>In the event of a fault, illumination of this warning lamp is accompanied by a warning message. | Contact a PEUGEOT dealer or a qualified workshop if automatic application / release is no longer possible.<br>The parking brake can be released manually.<br>For more information on the <b>Electric parking brake</b> and in particular the reactivation of the automatic functions, refer to the corresponding section. |



| Warning / indicator lamp   | State                                      | Cause  | Action / Observations  |  |
|--|--|--|--|--|
|       | <b>Braking</b>                             | fixed.                                       | The brake fluid level has dropped significantly.                   | You must stop as soon as it is safe to do so. Top-up with brake fluid listed by PEUGEOT. If the problem persists, have the system checked by a PEUGEOT dealer or a qualified workshop. |
| +<br> |  | fixed, associated with the ABS warning lamp. | The electronic brake force distribution (EBFD) system has a fault. | You must stop as soon as it is safe to do so. Have it checked by a PEUGEOT dealer or a qualified workshop.   |
|       | <b>Anti-lock Braking System (ABS)</b>      | fixed.                                       | The anti-lock braking system has a fault.                          | The vehicle retains conventional braking. Drive carefully at reduced speed and contact a PEUGEOT dealer or a qualified workshop without delay.   |
|       | <b>Dynamic stability control (DSC/ASR)</b> | flashing.                                    | The DSC/ASR regulation is operating.                               | The system optimises traction and improves the directional stability of the vehicle in the event of loss of grip or trajectory.  |
|  |  | fixed.                                       | The DSC/ASR system has a fault.                                    | Have the system checked by a PEUGEOT dealer or a qualified workshop.   |



| Warning / indicator lamp  |   | State   | Cause  | Action / Observations   |
|---|---|---|--|---|
|  | <b>Engine autodiagnosis system</b>        | flashing.   | The engine management system has a fault.  | Risk of destruction of the catalytic converter.<br>Have it checked by a PEUGEOT dealer or a qualified workshop.   |
|   |   | fixed.  | The emission control system has a fault.   | The warning lamp should go off when the engine is started.<br>If it does not go off, contact a PEUGEOT dealer or qualified workshop without delay.  |
|  | <b>Emergency Collision Braking System</b> | flashing.   | The Emergency Collision Braking System is active.                                    | The system brakes briefly so as to reduce the speed of collision with the vehicle ahead.  |
|   |   | fixed, accompanied by a message and an audible signal | The Emergency Collision Braking System has a fault.                                  | Have it checked by a PEUGEOT dealer or a qualified workshop.  |
|   |   | fixed.  | The Emergency Collision Braking System has been deactivated (via the menu).          |   |
|  | <b>Low fuel level</b>                     | fixed, with the needle in the red zone.               | When it first comes on, there remains <b>less than 6 litres of fuel</b> in the tank. | You must refuel as soon as possible to avoid running out of fuel.<br>This warning lamp will come on every time the ignition is switched on, until a sufficient addition of fuel is made.<br>Fuel tank capacity: approximately 53 litres or 45 litres (depending on version).<br>Never continue to drive until you run out of fuel, as this could damage the emission control and injection systems. |





| Warning / indicator lamp  |  | State   | Cause   | Action / Observations   |
|---|--|---|---|---|
|  | <b>Seat belt not fastened / unfastened</b> | fixed or flashing accompanied by an audible signal. | A seat belt has not been fastened or has been unfastened.   | Pull the strap then insert the tongue in the buckle.  |
|  | <b>Airbags</b>                             | on temporarily.                                     | This lamp comes on for a few seconds when you turn on the ignition, then goes off.                      | This lamp should go off when the engine is started. If it does not go off, contact a PEUGEOT dealer or a qualified workshop.        |
|   |  | fixed.  | One of the airbag or seat belt pretensioner systems has a fault.  | Have it checked by a PEUGEOT dealer or a qualified workshop.  |
|  | <b>Battery charge*</b>                     | fixed.  | The battery charging circuit has a fault (dirty or loose terminals, slack or cut alternator belt, ...). | The warning lamp should go off when the engine is started. If it does not go off, contact a PEUGEOT dealer or a qualified workshop. |

\* Depending on the country of sale.

| Warning / indicator lamp  |                            | State   | Cause   | Action / Observations  |
|---|----------------------------|---|---|--|
|  | <b>Engine oil pressure</b> | fixed.  | There is a fault with the engine lubrication system.                | You must stop as soon it is safe to do so. Park, switch off the ignition and contact a PEUGEOT dealer or a qualified workshop.   |
|  | <b>Under-inflation</b>     | fixed, accompanied by an audible signal and a message.        | The pressure in one or more tyres is too low.                       | Check the tyre pressures as soon as possible. This check should preferably be carried out when the tyres are cold. You must reinitialise the system after the adjustment of one or more tyre pressures and after changing one or more wheels. For more information on <b>Under-inflation detection</b> , refer to the corresponding section. |
| <b>+</b><br><b>SERVICE</b>  |                            | flashing then fixed, accompanied by the Service warning lamp. | The system has a fault: the tyre pressures are no longer monitored. | Check the tyre pressures as soon as possible. Have the system checked by a PEUGEOT dealer or a qualified workshop.   |



| Warning / indicator lamp  |                                | State  | Cause  | Action / Observations   |
|---|--------------------------------|--------|--|---|
|  | <b>Foot on the brake pedal</b> | fixed. | The brake pedal must be pressed.   | With an automatic gearbox, press the brake pedal, engine running, before releasing the parking brake, to unlock the lever and come out of position <b>P</b> .<br>If you wish to release the parking brake without pressing the brake pedal, this warning lamp will remain on. |
|  | <b>Foot on the clutch</b>      | fixed. | In the STOP mode of Stop & Start, the change to START mode is denied because the clutch pedal is not fully down. | If your vehicle has a manual gearbox, you must declutch fully to allow the change to engine START mode.   |

| Warning or indicator lamp in the instrument panel                                 |                     | State   | Cause                             | Action / Observations   |
|---|---------------------|---|-----------------------------------|-------------------------|
|  | <b>Door(s) open</b> | fixed, associated with a message identifying the door, if the speed is below 6 mph (10 km/h).                                 | A door or the boot is still open. | Close the door or boot. |
|   |                     | fixed, associated with a message identifying the door, together with an audible signal if the speed is above 6 mph (10 km/h). |                                   |                         |

| Warning or indicator lamp in the instrument panel   |                                     | State  | Cause  | Action / Observations   |
|---|-------------------------------------|--|--|---|
| UREA<br> | <b>AdBlue®<br/>(BlueHDi Diesel)</b> | fixed, on switching on the ignition, accompanied by an audible signal and a message indicating the remaining driving range.                | The remaining driving range is between 350 miles (600 km) and 1500 miles (2400 km).                                | Top-up the AdBlue® as soon as possible or go to a PEUGEOT dealer or a qualified workshop.   |
|   |                                     | flashing, associated with the SERVICE warning lamp, accompanied by an audible signal and a message indicating the remaining driving range. | The remaining driving range is between 0 and 350 miles (600 km).   | You must <b>top-up the AdBlue® to avoid a breakdown</b> or go to a PEUGEOT dealer or a qualified workshop.  |
|   |                                     | flashing, associated with the SERVICE warning lamp, accompanied by an audible signal and a message indicating that starting is prevented.  | The AdBlue® tank is empty: the starting inhibition system required by legislation prevents starting of the engine. | To be able to start the engine, you must <b>top-up</b> the AdBlue® or call on a PEUGEOT dealer or a qualified workshop.<br>It is <b>essential</b> to add at least 3.8 litres of AdBlue® to the fluid tank |
| +   | SERVICE                             |  |  |   |



For topping-up or for more information on **AdBlue® and the SCR system**, refer to the corresponding section.

| Warning or indicator lamp in the instrument panel  |  | State   | Cause  | Action / Observations   |
|--|--|---|--|---|
| <br>+<br><br>+<br> | <b>SCR emissions control system (BlueHDi Diesel)</b> | fixed, on switching on the ignition, associated with the SERVICE and engine diagnostic warning lamps, accompanied by an audible signal and a message.   | A fault with the SCR emissions control system has been detected.   | This alert disappears once the exhaust emissions return to normal levels.                         |
|  |  | flashing, on switching on the ignition, associated with the SERVICE and engine diagnostic warning lamps, accompanied by an audible signal and a message indicating the remaining driving range. | After confirmation of the fault with the emissions control system, you can drive for up to 650 miles (1 100 km) before the engine starting inhibition system is triggered.                 | Contact a PEUGEOT dealer or a qualified workshop <b>without delay, to avoid a breakdown.</b>      |
|  |  | flashing, on switching on the ignition, associated with the SERVICE and engine diagnostic warning lamps, accompanied by an audible signal and a message.  | You have exceeded the authorised driving limit following confirmation of a fault with the emissions control system: the engine starting inhibition system prevents starting of the engine. | To be able to start the engine, you <b>must</b> call on a PEUGEOT dealer or a qualified workshop. |

## Gauges and indicators

### Coolant temperature gauge



With the engine running, when the needle is:

- in zone **A**, the temperature is correct,
- in zone **B**, the temperature is too high; the maximum temperature and the central **STOP** warning lamps come on, accompanied by an audible signal and a warning message in the screen.

**You MUST stop as soon as it is safe to do so.**

Wait a few minutes before switching off the engine.

Contact a PEUGEOT dealer or a qualified workshop.

After driving for a few minutes, the temperature and pressure in the cooling system increase.

To top-up the level:

- ☞ wait for the engine to cool,
- ☞ unscrew the cap slightly to allow the pressure to drop,
- ☞ when the pressure has dropped, remove the cap,
- ☞ top-up the level to the "MAX" mark.

**!** Be aware of the risk of burns when topping up the cooling system. Do not fill above the maximum level (indicated on the header tank).

### Service indicator

System which informs the driver when the next service is due, in accordance with the manufacturer's servicing schedule.

The point at which the next service is due is calculated from the last indicator zero reset, depending on the distance travelled and the time elapsed since the last service.

For BlueHDi Diesel versions, the degree of deterioration of the engine oil is also taken into account (depending on the country of sale).



**More than 1 800 miles (3 000 km) remain before the next service is due**

When the ignition is switched on, no service information appears in the screen.

### Between 600 miles (1 000 km) and 1 800 miles (3 000 km) remain before the next service is due

For 5 seconds after the ignition is switched on, the spanner symbolising the service operations comes on. The distance recorder display line indicates the distance remaining before the next service is due.

**Example:** 1 700 miles (2 800 km) remain before the next service is due.

For 5 seconds after the ignition is switched on, the screen indicates:



5 seconds after the ignition is switched on, **the spanner goes off**; the distance recorder resumes its normal operation. The screen then indicates the total distance.



### Less than 600 miles (1 000 km) remain before the next service is due

**Example:** 560 miles (900 km) remain before the next service is due.

For 5 seconds after the ignition is switched on, the screen indicates:



5 seconds after the ignition is switched on, the distance recorder resumes its normal operation. **The spanner remains on** to indicate that a service must be carried out soon.



### Service overdue

For 5 seconds after the ignition is switched on, **the spanner flashes** to indicate that the service must be carried out as soon as possible.

**Example:** the service is overdue by 180 miles (300 km).

For 5 seconds after the ignition is switched on, the screen indicates:



5 seconds after the ignition is switched on, the distance recorder resumes its normal operation. **The spanner remains on.**

For BlueHDi Diesel versions, this alert may also be accompanied by the fixed illumination of the service warning lamp when the ignition is on.

**i** The distance remaining may be weighted by the time factor, depending on the driving conditions. Therefore, the spanner may also come on if you have exceeded the period since the last service, indicated in the manufacturer's service schedule. For BlueHDi Diesel versions, the spanner may also be brought on earlier than expected, depending on the degree of deterioration of the engine oil (depending on the country of sale). The rate of deterioration of the engine oil depends on the driving conditions in which the vehicle is used.

## Resetting the service indicator



After each service, the service indicator must be reset to zero.

If you have carried out the service on your vehicle yourself:

- ☞ switch off the ignition,
- ☞ press and hold the trip distance recorder reset button,
- ☞ switch on the ignition; the distance recorder display begins a countdown,
- ☞ when the display indicates "**=0**", release the button; the spanner disappears.

**i** If you have to disconnect the battery following this operation, lock the vehicle and wait at least 5 minutes for the reset to be registered.

## Retrieving the service information

You can access the service information at any time.

- ☞ Press the trip distance recorder reset button.

The service information is displayed for a few seconds, then disappears.



## Engine oil level indicator

On versions fitted with an electric oil gauge, information on the conformity of the oil level is displayed in the instrument panel for a few seconds when the ignition is switched on, at the same time as the service information.

**i** The level read will only be correct if the vehicle is on level ground and the engine has been off for more than 30 minutes.

### Oil level correct

OIL OK

This is indicated by a message in the instrument panel.

### Oil level incorrect

OIL

This is indicated by a message in the instrument panel.

If the low oil level is confirmed by a check using the dipstick, the level must be topped-up to avoid damage to the engine.

### Oil level indicator fault

OIL \_ \_

This is indicated by a message in the instrument panel. Contact a PEUGEOT dealer or a qualified workshop.

### Dipstick

**i** To locate the dipstick and the oil filler cap on a **Petrol engine** or a **Diesel engine**, refer to the corresponding section.



There are 2 marks on the dipstick:

- **A** = max; never exceed this level,
- **B** = min; top-up the level via the oil filler, using the grade of oil suited to your engine.

## AdBlue® fluid range indicators

Once the AdBlue® tank is on reserve or after detection of a fault with the SCR emissions control system, when the ignition is switched on an indicator displays an estimate of the distance that can be covered, the range, before engine starting is prevented.

In the event of simultaneous system fault and low AdBlue® level, the shortest range figure is the one displayed.

### In the event of the risk of non-starting related to a lack of AdBlue®

#### Remaining range greater than 1 500 miles (2 400 km)

When switching on the ignition, there is no automatic display of range in the instrument panel.



Pressing this button will display the remaining range.

You can access this information in the touch screen, if your vehicle has one.



☞ Select the "**Driving assistance**" menu.



☞ Then "**Diagnostic**".

CHECK



The range at that moment is then displayed.

Above 3 000 miles (5 000 km), the value is not specified.

#### Remaining range between 350 and 1500 miles (600 and 2 400 km)



When switching on the ignition, the UREA warning lamp comes on, accompanied by an audible signal and the display of a message (e.g. "Top-up emissions additive: Starting prevented in 900 miles") indicating the remaining range expressed in miles or kilometres.

When driving, the message is displayed every 200 miles (300 km) until the AdBlue® fluid has been topped-up.

Go to a PEUGEOT dealer or a qualified workshop to have the AdBlue® topped-up. You can also top-up the tank yourself.

**!** The engine start prevention system required by regulations is activated automatically once the AdBlue® tank is empty.

**i** For more information on **AdBlue® and the SCR system**, and topping-up in particular, refer to the corresponding section.

**Remaining range between 0 and 350 miles (0 and 600 km)**

When switching on the ignition, the SERVICE warning lamp comes on and the UREA warning lamp flashes, accompanied by an audible signal and the display of a message (e.g. "Top-up emissions additive: Starting prevented in 350 miles") indicating the remaining range expressed in miles or kilometres.

When driving, the message is displayed every 30 seconds until the AdBlue® fluid has been topped-up.

Go to a PEUGEOT dealer or a qualified workshop to have the AdBlue® topped-up. You can also top-up the tank yourself. Otherwise you will not be able to restart your engine.

**Breakdown related to a lack of AdBlue® additive**

When switching on the ignition, the SERVICE warning lamp comes on and the UREA warning lamp flashes, accompanied by an audible signal and the display of the message "Top-up emissions additive: Starting prevented". The AdBlue® tank is empty: the system required by regulations prevents engine starting.

**!** To be able to start the engine, we recommend that you call on a PEUGEOT dealer or a qualified workshop for the top-up required. If you carry out the top-up yourself, it is essential to add at least 3.8 litres of AdBlue® to the tank.

**i** For more information on **AdBlue® and the SCR system**, and topping-up in particular, refer to the corresponding section.

## In the event of a fault with the SCR emissions control system

**!** A system that prevents engine starting is activated automatically from 650 miles (1 100 km) after confirmation of a fault with the SCR emissions control system. Have the system checked by a PEUGEOT dealer or a qualified workshop as soon as possible.

### In the event of the detection of a fault



The UREA, SERVICE and diagnostic warning lamps come on, accompanied by an audible signal and the display of the message "Emissions fault".

The alert is triggered when driving when the fault is detected for the first time, then when switching on the ignition for subsequent journeys, while the fault persists.

**i** If it is a temporary fault, the alert disappears during the next journey, after self-diagnosis of the SCR system.

### During an authorised driving phase (between 650 miles and 0 miles) (1 100 km and 0 km)



If a fault with the SCR system is confirmed (after 30 miles (50 km) covered with the permanent display of the message signalling a fault), the SERVICE and engine diagnostic warning lamps come on and the UREA warning lamp flashes, accompanied by an audible signal and the display of a message (e.g.: "Emissions fault: Starting prevented in 150 miles") indicating the remaining range express in miles or kilometres. While driving, the message is displayed every 30 seconds while the fault with the SCR system persists.

The alert is repeated when switching on the ignition.

You should go to a PEUGEOT dealer or a qualified workshop as soon as possible.

Otherwise, you will not be able to restart your engine.

### Starting prevented



Every time the ignition is switched on, the SERVICE and engine diagnostic warning lamps come on and the UREA warning lamp flashes, accompanied by an audible signal and the display of the message "Emissions fault: Starting prevented".

**!** You have exceeded the authorised driving limit: the starting prevention system inhibits engine starting.

To be able to start the engine, you must call on a PEUGEOT dealer or a qualified workshop.

## Distance recorders

The total and trip distances are displayed for thirty seconds when the ignition is switched off, when the driver's door is opened and when the vehicle is locked or unlocked.

**i** When travelling abroad, you may have to change the units of distance: the display of road speed must be in the official units (miles or km) for the country. The change of units is done via the screen configuration menu, with the vehicle stationary.

### Total distance recorder

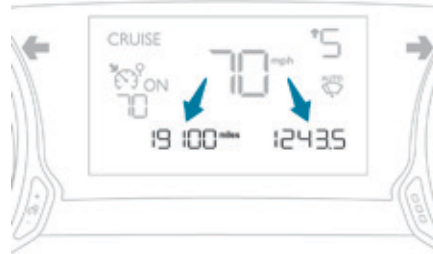

It measures the total distance travelled by the vehicle since its first registration.

### Trip distance recorder

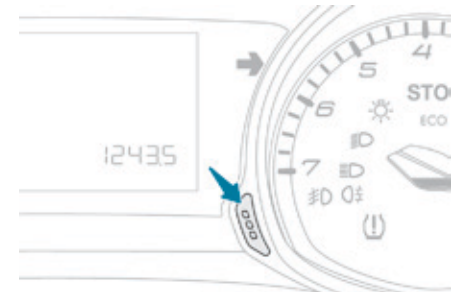

It measures the distance travelled since it was reset to zero by the driver.

- ☞ With the ignition on, press the button until zeros appear.

## Lighting dimmer control

For the manual adjustment of the brightness of the instrument panel and the touch screen.

- i** Operates only when the vehicle's exterior lighting is on.

### Instrument panel



With the exterior lighting on, press this button to adjust the brightness of the dashboard lighting, the touch screen and the mood lighting. As soon as the lighting reaches the required level of brightness, release the button.

### Touch screen

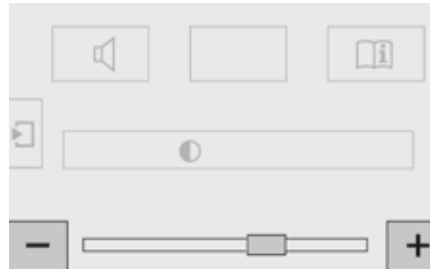

- g** Press on the "**Configuration**" menu.
- g** Adjust the brightness (only on the touch screen) by pressing on the "+" or "-" buttons.

# Trip computer

System that gives you information on the current journey (range, fuel consumption...).

## Depending on version Instrument panel screen

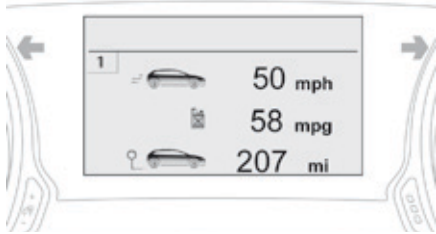

## Information display

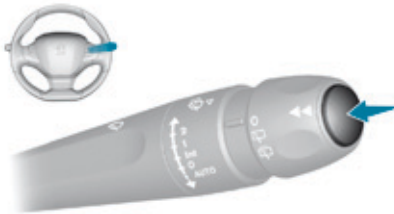

- ☞ Press the button on the end of the **wiper control stalk** to display the various tabs in succession.

- The current information tab with:
  - the range,
  - the current fuel consumption,
  - the Stop & Start time counter.

1

- Trip "1" with:
  - the average speed,
  - the average fuel consumption,
  - the distance travelled, for the first trip.

2

- Trip "2" with:
  - the average speed,
  - the average fuel consumption,
  - the distance travelled, for the second trip.

## Trip reset



- ☞ When the trip required is displayed, press the control for more than two seconds or use the left-hand thumbwheel of the steering mounted controls.
- Trips "1" and "2" are independent but their use is identical.
- For example, trip "1" can be used for daily figures, and trip "2" for monthly figures.

# Trip computer

## Touch screen

System that gives you information on the current journey (range, fuel consumption...).

The information is accessible in the "**Driving assistance**" menu.

## Information display in the touch screen



Permanent display:

- ☞ Select the "**Driving assistance**" menu.
- The trip computer information is displayed in the primary page of the menu.
- ☞ Press one of the buttons to display the desired tab.

Temporary display in a new window:

- ☞ Press the end of the wiper control stalk for access to the information and display the different tabs.



The current fuel consumption tab with:

- the range,
- the current fuel consumption,
- the Stop & Start time counter.



The trip "1" tab with:

- the distance travelled,
- the average fuel consumption,
- the average speed, for the first trip.



The trip "2" tab with:

- the distance travelled,
- the average fuel consumption,
- the average speed, for the second trip.

## Trip reset

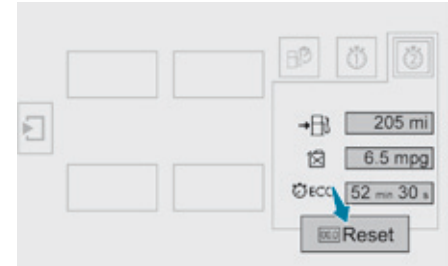

- ☞ When the desired trip is displayed, press the reset button or on the end of the wiper control stalk.

Trips "1" and "2" are independent but their use is identical.

For example, trip "1" can be used for daily figures, and trip "2" for monthly figures.



## Trip computer, a few definitions



### Range

(miles or km)

The distance which can still be travelled with the fuel remaining in the tank (related to the average fuel consumption over the last few miles (kilometres) travelled).



This value may vary following a change in the style of driving or the relief, resulting in a significant change in the current fuel consumption.

When the range falls below 20 miles (30 km), dashes are displayed. After filling with at least 5 litres of fuel, the range is recalculated and is displayed when it exceeds 60 miles (100 km).



If dashes are displayed continuously while driving in place of the digits, contact a PEUGEOT dealer or a qualified workshop.



### Current fuel consumption

(mpg or l/100 km or km/l)

Calculated over the last few seconds.



This function is only displayed from 20 mph (30 km/h).



### Average fuel consumption

(mpg or l/100 km or km/l)

Calculated since the last trip computer reset.



### Average speed

(mph or km/h)

Calculated since the last trip computer reset.



### Distance travelled

(miles or km)

Calculated since the last trip computer reset.



### Stop & Start time counter

(minutes / seconds or hours / minutes)

A time counter calculates the time spent in STOP mode during a journey. It resets to zero every time the ignition is switched on.

# Touch screen

It gives access to:

- the heating/air conditioning controls,
- menus for adjusting settings for vehicle functions and systems,
- audio and display configuration menus,
- audio system and telephone controls and the display of associated information.

And, depending on equipment, it allows:

- the display of alert messages and the visual parking sensors information,
- access to the controls for the navigation system and Internet services, and the display of associated information.

**!** For reasons of safety, the driver should only carry out operations that require close attention, with the vehicle stationary.

Some functions are not accessible when driving.

## General operation

### Recommendations

It is necessary to press firmly, particularly for "flick" gestures (scrolling through lists, moving the map...).

A light wipe is not enough.

The screen does not recognise pressing with more than one finger.

This technology allows use at all temperatures and when wearing gloves.

Do not use pointed objects on the touch screen.

Do not touch the touch screen with wet hands.

Uses a soft clean cloth to clean the touch screen.

### State of indicator lamps

Some buttons contain an indicator lamp that gives the state of the corresponding function. Green indicator: you have switched on the corresponding function.

Orange indicator: you have switched off the corresponding function.

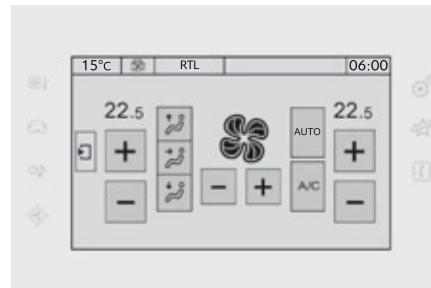

## Principles

Use the buttons on either side of the touch screen for access to the menus, then press the virtual buttons in the touch screen.

Each menu is displayed over one or two pages (primary page and secondary page).



Use this button to go to the secondary page.



Use this button to return to the primary page.

**i** After a few moments with no action on the secondary page, the primary page is displayed automatically.



Use this button for access to additional information and to the settings for certain functions.



Use this button to confirm.



Use this button to quit.

## Touch screen menus

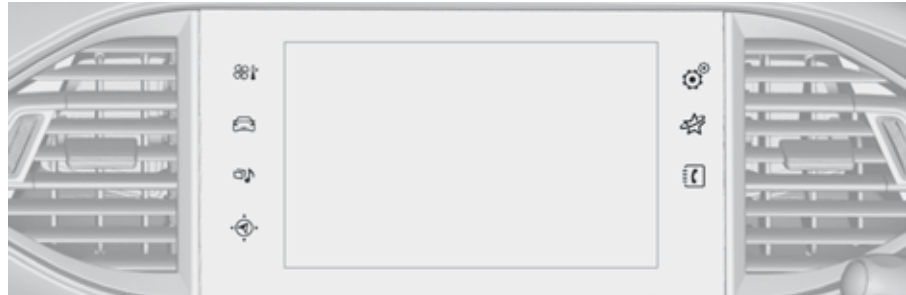

### Air conditioning.

Allows adjustment of the various settings for temperature, air flow... See the sections on "Heating", "Manual air conditioning" and "Digital air conditioning".



### Driving assistance.

Allows certain functions to be switched on and off and their settings adjusted.



### Media.

See the "Audio equipment and telematics" section.



### Navigation.

Depending on trim level, navigation can be not available, an option or standard. See the "Audio equipment and telematics" section.



### Configuration.

Allows configuration of the display and the system.



### Connected services.

These services can be not available, an option or standard. See the "Audio equipment and telematics" section.



### Telephone.

See the "Audio equipment and telematics" section.





**1.** Volume / mute.  
See the "Audio equipment and telematics" section.



## "Driving assistance" menu

The systems with settings that can be adjusted are detailed in the table below.

| Button   | Corresponding function                | Comments   |
|--|---------------------------------------|--|
| A circular icon representing a speedometer, with a needle and a scale.                             | <b>Speed settings</b>                 | Memorisation of speeds for use with the speed limiter or cruise control. |
| A circular icon with an exclamation mark inside, representing a warning for under-inflation.       | <b>Under-inflation initialisation</b> | Reinitialisation of the under-inflation system.                          |
| An icon showing a car with two rectangular sensors on its sides, representing blind spot sensors.  | <b>Blind spot sensors</b>             | Activation of the function.  |
| The letter 'P' above a circular icon with a steering wheel, representing the Park Assist function. | <b>Park Assist</b>                    | Activation/Deactivation of the function                                  |

| Button  | Corresponding function        | Comments  |
|---|-------------------------------|---|
|  | <b>Vehicle settings</b>       | <p>Access to other functions with settings that can be adjusted.<br/>           Select or deselect the tabs at the bottom of the screen to display the functions required.</p> <ul style="list-style-type: none"> <li>- <b>"Driving assistance"</b> <ul style="list-style-type: none"> <li>- "[Automatic rear wiper in reverse]" (activation of rear wiper coupled to reverse gear).</li> </ul> </li> </ul> <p>For more information on the <b>Wiper control stalk</b>, refer to the corresponding section.</p> <ul style="list-style-type: none"> <li>- "[Collision risk alert]" (activation of the collision risk alert system).</li> </ul> <p>For more information on <b>Collision risk alert and emergency automatic braking</b>, refer to the corresponding section.</p> <ul style="list-style-type: none"> <li>- <b>"Lighting"</b> <ul style="list-style-type: none"> <li>- "[Guide-me-home lighting]" (automatic guide-me-home lighting),</li> <li>- "[Welcome lighting]" (exterior welcome lighting).</li> </ul> </li> </ul> <p>For more information on the <b>Lighting control stalk</b>, refer to the corresponding section.</p> <ul style="list-style-type: none"> <li>- "[Mood lighting]" (interior mood lighting).</li> </ul> <p>For more information on <b>Mood lighting</b>, refer to the corresponding section.</p> <ul style="list-style-type: none"> <li>- <b>"Vehicle access"</b> <ul style="list-style-type: none"> <li>- "[Driver plip action]" (selective unlocking of the driver's door).</li> </ul> </li> </ul> <p>For more information on the <b>Remote control</b> or <b>Keyless Entry and Starting</b>, refer to the corresponding section.</p> <ul style="list-style-type: none"> <li>- "[Unlocking boot]" (selective unlocking of the boot).</li> </ul> <p>For more information on the <b>Boot</b>, refer to the corresponding section.</p> |
| CHECK   | <b>Diagnostic</b>             | List of current alerts.   |
|  | <b>Parking sensors</b>        | Activation/Deactivation of the function.  |
|  | <b>Dynamic cruise control</b> | Choice of the standard cruise control or the dynamic cruise control.<br>The choice of dynamic cruise control is retained on condition that the steering mounted control thumbwheel is at the "CRUISE" position.   |

## State of adjustable systems

Some systems have a dedicated button, to which is associated an indicator lamp.

Illumination of this lamp indicates whether the system is activated or deactivated compared to the default (factory) setting.

Green indicator: you have switched on the corresponding system.

Orange indicator: you have switched off the corresponding system.

### Operating fault

In the event of a fault with one of these systems, the indicator lamp in the activation/deactivation button flashes for a few moments.

An alert symbol is displayed to the right of the button symbol, then, in the case of systems that are activated by default, the orange indicator comes on permanently.

Every time the button is pressed, the indicator flashes for a few moments.

Example:

- Function not activated.

AUTO  

- Operating fault alert.







  
 AUTO !  







then

AUTO !  

## "Configuration" menu

The functions available through this menu are detailed in the table below.

| Button   | Corresponding function  | Comments                              |
|--|-------------------------|---------------------------------------|
|   | <b>Audio settings</b>   | Adjustment of volume, balance...      |
|   | <b>Colour schemes</b>   | Choice of colour scheme.              |
|   | <b>Interactive help</b> | Access to the interactive user guide. |
|   | <b>Turn off screen</b>  |                                       |
| <br> | <b>Brightness</b>       |                                       |

| Button  | Corresponding function | Comments  |
|---|------------------------|---|
|  | <b>System Settings</b> | Choice of units: <ul style="list-style-type: none"><li>- temperature (°Celsius or °Fahrenheit)</li><li>- distance and fuel consumption (l/100 km, mpg or km/l).</li></ul> |
|  | <b>Time/Date</b>       | Setting the date and time.  |
|  | <b>Languages</b>       | Choice of language used: French, English, Italian, Spanish, German, Dutch, Portuguese, Polish, Turkish, Russian, Serbian, Croat, Hungarian, Czech, Brazilian.             |
|  | <b>Screen settings</b> | Adjustment of the display settings (scrolling of text, animations...)   |
|  | <b>Calculator</b>      |   |
|  | <b>Calendar</b>        |   |



# Setting the date and time

## Touch screen

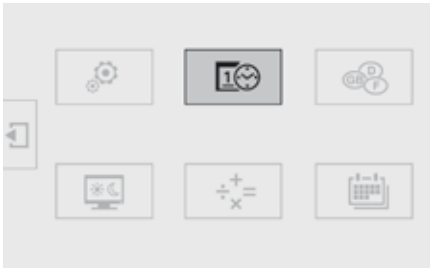

This function is accessible in the touch screen.



- ☞ Select the "**Configuration**" menu.

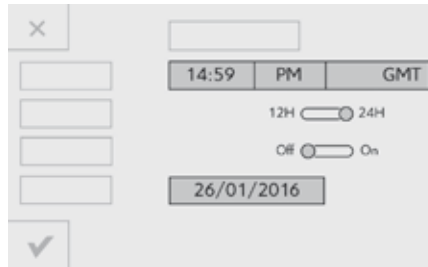

- ☞ In the secondary page, press on "**Time/Date**".



- ☞ Select "**Adjust time**" or "**Adjust date**" and modify the settings using the numeric keypad, then confirm.



- ☞ Press "**Confirm**" to quit.

## Screen C

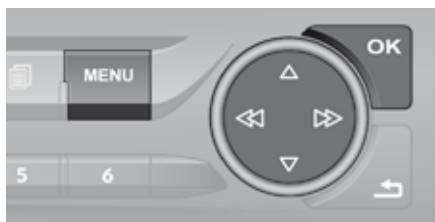

- ☞ Press the **MENU** button for access to the **main menu**.

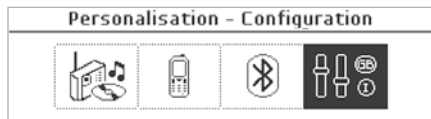

- ☞ Press the "◀" or "▶" button to select the **Personalisation-configuration** menu, then confirm by pressing the **"OK"** button.



- ☞ Press the "▲" or "▼" button to select the **Display configuration** menu then confirm by pressing the **"OK"** button.
- ☞ Press the "▲" or "▼" and "◀" or "▶" buttons to set the date and time, then confirm by pressing the **"OK"** button.

**i** For more information on the **Multimedia** menu, refer to the "Audio and telematics" section.

## Screen A



- ☞ Press the **"MENU"** button to gain access to the **main menu**, then press the **"▲"** or **"▼"** buttons to go to the **Display settings menu**.
- ☞ Press the **"OK"** button to select the menu required.

You have access to the following settings:

- year,
- month,
- day,
- hour,
- minutes,
- 12 or 24 hour mode.



- ☞ Once you have selected a setting, press the **"◀"** or **"▶"** buttons to change its value.



- ☞ Press the **"▲"** or **"▼"** buttons to switch respectively to the previous or next setting.
- ☞ Press the **"OK"** button to register the change and return to the normal display or press the **"J]"** button to cancel.

## Screen A (without audio system)



- ☞ Once you have selected a setting using the **"▲"** or **"▼"** buttons, press the **"OK"** button to change its value.
- ☞ Wait for approximately ten seconds without any action to allow the change to be registered or press the **"ESC"** button to cancel.

The screen then returns to the normal display.

## Remote control key

System for the central locking or unlocking of the vehicle using the door lock or from a distance.

It is also used to open and close the fuel filler cap, locate and start the vehicle, as well as providing protection against theft.

### Unfolding / Folding the key



☞ Press this button to unfold or fold the key.

**!** If you do not press the button, you risk damaging the remote control.

## Complete unlocking

### Using the key

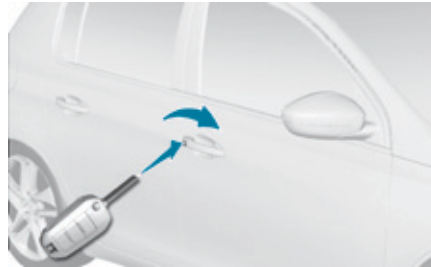

☞ Turn the key to the front of the vehicle to unlock the vehicle, then pull the handle to open the door.

If your vehicle has an alarm, this is not deactivated. Opening a door will trigger the alarm, which can then be stopped by switching the ignition on.

### Using the remote control



☞ Press this button to unlock the vehicle.

**i** Unlocking is confirmed by rapid flashing of the direction indicators for approximately two seconds. According to version, the door mirrors unfold at the same time.

## Selective unlocking

Complete unlocking is activated by default. This is set in the "**Driving assistance**" menu, then "**Vehicle settings**" and "**Vehicle access**".



Use this button for access to additional information.

## Using the remote control



To unlock the driver's door only, press this button once.

To unlock the other doors and the boot, press this button again



Unlocking is confirmed by rapid flashing of the direction indicators for approximately two seconds. According to version, the door mirrors unfold at the same time as the first unlocking action.

## Normal locking

### Using the key



Turn the key towards the rear of the vehicle to fully lock the vehicle.

If your vehicle has an alarm, this will not be activated.

### Using the remote control



Press this button to fully lock the vehicle.

Maintaining the locking action (key or remote control) automatically closes the windows.



Locking is confirmed by fixed lighting of the direction indicators for approximately two seconds. According to version, the door mirrors fold at the same time.



Driving with the doors locked may render access for the emergency services difficult in an emergency. As a safety measure (children on board), never leave the vehicle without taking your key, even for a short period.



When a door or the boot is not fully closed, engine running or vehicle moving (speed above 6 mph (10 km/h)), a message appears for a few seconds.

**i** If one of the doors or the boot is still open, the central locking does not take place.

When the vehicle is locked, if it is unlocked inadvertently, it will lock itself again automatically after about thirty seconds unless a door is opened.

And if your vehicle has an alarm, this will not be reactivated.

The folding and unfolding of the door mirrors by the remote control can be deactivated by a PEUGEOT dealer or a qualified workshop.

## Deadlocking

**!** Deadlocking renders the exterior and interior door controls inoperative. It also deactivates the manual central control button. Therefore, never leave anyone inside the vehicle when it is deadlocked.

## Using the key

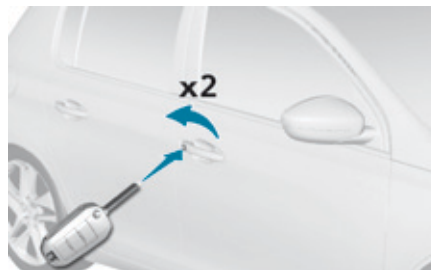

- ☞ Turn the key to the rear in the driver's door lock to lock the vehicle completely.
- ☞ Turn the key to the rear again within five seconds to deadlock the vehicle.

## Using the remote control



- ☞ Press this button to fully lock the vehicle.
- ☞ Press this button again within five seconds to deadlock the vehicle.

**i** Deadlocking is confirmed by fixed lighting of the direction indicators for approximately two seconds. Depending on version, the door mirrors fold at the same time.

## Locating your vehicle

This function allows you to identify your vehicle from a distance, particularly in poor light. Your vehicle must be locked.



Press this button.

This will switch on the courtesy lamps and the direction indicators will flash for around ten seconds.

## Remote operation of lighting



A short press this button switches on the lighting remotely (sidelamps, dipped beam headlamps and number plate lamps).

A second press before the end of the timed period cancels the remote lighting.

## Anti-theft protection

### Electronic engine immobiliser

The key contains an electronic chip which has a special code. When the ignition is switched on, this code must be recognised in order for starting to be possible.

This electronic engine immobiliser locks the engine management system a few moments after the ignition is switched off and prevents starting of the engine by anyone who does not have the key.

**SERVICE** In the event of a fault, you are informed by illumination of this warning lamp, an audible signal and a message in the screen.

In this case, your vehicle will not start; contact a PEUGEOT dealer as soon as possible.

**i** Keep safely, away from your vehicle, the label attached to the keys given to you on acquisition of the vehicle.

## Back-up control

For mechanically locking and unlocking the doors in the event of a fault with the central locking system or a battery failure.

### Driver's door



- ☞ Insert the key in the lock to lock or unlock the door.

### Passenger doors

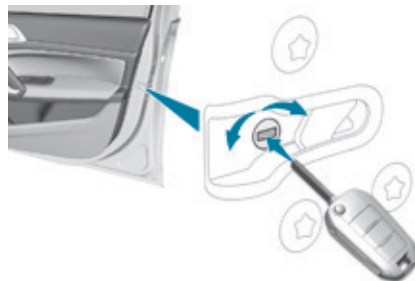

- ☞ On the rear doors, check that the child lock is not on.
- ☞ Insert the integral key into the latch on the edge of the door and turn it an eighth of a turn to the right, for the right-hand side and to the left for the left-hand side.
- ☞ Close the doors and check from the outside that they have locked correctly.

## Remote control problem

Following disconnection of the vehicle battery, replacement of the remote control battery or in the event of a remote control malfunction, you can no longer unlock, lock or locate your vehicle.

- ☞ First of all, use the key in the lock to unlock or lock your vehicle.
  - ☞ Then, reinitialise the remote control.
- If the problem persists, contact a PEUGEOT dealer as soon as possible.

**i** If your vehicle has an alarm, it will not be activated and deactivated on locking and unlocking the vehicle. Opening a door will trigger the alarm, which can be stopped by switching on the ignition.



## Reinitialisation

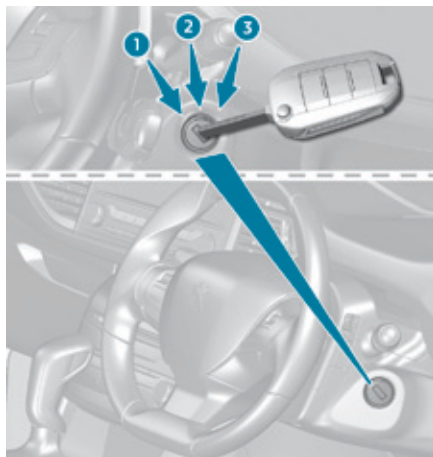

- ☞ Switch off the ignition.
- ☞ Turn the key to position **2 (Ignition)**.
- ☞ Press the closed padlock immediately for a few seconds.



- ☞ Switch off the ignition and remove the key from the ignition switch.
- The remote control is fully operational again.

## Changing the battery



Battery ref.: CR1620 / 3 volts.

- SERVICE** If the battery is flat, you are informed by lighting of this warning lamp in the instrument panel, an audible signal and a message in the screen.
- ☞ Unclip the cover using a screwdriver in the cut-out.
  - ☞ Remove the cover.
  - ☞ Remove the flat battery from its housing.
  - ☞ Place the new battery into its housing, observing the polarity.
  - ☞ Clip the cover in place.



Do not throw the remote control batteries away, they contain metals which are harmful to the environment. Take them to an approved collection point.

# "Keyless Entry and Starting" with remote control

System for the central locking or unlocking of the vehicle using the door lock or from a distance.

It is also used to locate and start the vehicle, as well as providing protection against theft.

## Complete unlocking



Press this button to unlock the vehicle.

## Selective unlocking

Complete unlocking is activated by default.

This setting is done in the "**Driving assistance**" menu, then "**Vehicle settings**" and "**Vehicle access**".



Use this button for access to additional information.



To unlock only the driver's door, press this button once.

To unlock the other doors and the boot, press this button again.



Unlocking is confirmed by rapid flashing of the direction indicators for two seconds.

At the same time, depending on version, the door mirrors unfold. And if your vehicle has an alarm, it is deactivated

## Locking



Press this button to fully lock the vehicle.

Hold the button down until the windows close completely.



Locking is confirmed by fixed illumination of the direction indicators for a few seconds.

Depending on version, the door mirrors fold and the alarm is activated



Driving with the doors locked may make access to the passenger compartment by the emergency services difficult in the event of an emergency. Be aware of children when operating the windows.



If a door or the boot is not properly closed, with the **engine running** or the **vehicle moving** (speed above 6 mph (10 km/h)), a message appears for a few seconds.

## Locating your vehicle

This function allows you to identify your vehicle from a distance, particularly in poor light. Your vehicle must be locked.



☞ Press this button.

This will switch on the courtesy lamps and the direction indicators will flash for around ten seconds.



As a safety measure (children on board), never leave the vehicle without taking the key for the Keyless Entry and Starting system, even for a short period.

Guard against theft when the key for the Keyless Entry and Starting system is in the recognition zone with the vehicle unlocked.

In order to preserve the charge of the cell battery in the remote control, the "hands-free" functions go into extended stand-by after 21 days of non-use. To restore these functions, press one of the remote control buttons or start the engine with the electronic key in the reader.

## "Keyless Entry and Starting"

System for unlocking, locking and starting the vehicle while keeping the electronic key on your person.

- i** The central locking does not take place:
- if the ignition is on,
  - if one of the doors or the boot is still open,
  - if the key for the Keyless Entry and Starting system has been left inside the vehicle.

When the vehicle is locked, if it is unlocked inadvertently, it will lock itself again automatically after about thirty seconds unless a door is opened. And if your vehicle has an alarm, this is not reactivated.

The folding and unfolding of the door mirrors by the remote control can be deactivated by a PEUGEOT dealer or a qualified workshop.

### Complete unlocking



- ☞ With the electronic key on your person and in the recognition zone **A**, pass your hand behind one of the front door handles to unlock the vehicle, then pull on the handle to open the door.

### Selective unlocking

When selective unlocking of the driver's door is activated:

- ☞ With the electronic key in the driver's door zone, pass your hand behind the driver's door handle to unlock just the driver's door, then pull on the door handle to open the door.
- ☞ With the electronic key in the passenger's door zone, pass your hand behind the passenger's door handle to unlock the whole vehicle, then pull on the door handle to open the door.

By default, complete unlocking is activated. This setting is done in the "**Driving assistance**" menu, then "**Vehicle settings**" and "**Vehicle access**".



Use this button for access to additional information.

- i** Unlocking is confirmed by rapid flashing of the direction indicators for a few seconds. Depending on version, the door mirrors unfold and the alarm is deactivated.

## Locking



- With the electronic key in the recognition zone **A**, press with a finger on one of the front door handles (at the markings) or press the locking control on the tailgate to lock the vehicle.  
Maintain pressure with your finger until the windows close completely.



If a door or the boot is not properly closed, with the **engine running** or the **vehicle moving** (speed above 6 mph (10 km/h)), a message appears for a few seconds.



Locking is confirmed by fixed illumination of the direction indicators for a few seconds. Depending on version, the door mirrors fold and the alarm is activated.

- Ensure that nobody prevents the correct operation of the windows. Be aware of children when operating the windows.

**!** For reasons of safety and theft protection, do not leave your electronic key in the vehicle, even when you are close to it.

It is recommended that you keep it on your person.

## Deadlocking

- ! Deadlocking renders the exterior and interior door controls inoperative. It also deactivates the manual central locking button. You must therefore never leave anyone inside the vehicle when it is deadlocked.

## Using the remote control



- ☞ Press this button to lock the vehicle completely. Maintain pressure with your finger to close the windows.
- ☞ Press this button again within five seconds to deadlock the vehicle.

- ! Ensure that nothing or any person prevents the correct closing of the windows. Be particularly aware of children when operating the windows.

## With Keyless Entry and Starting

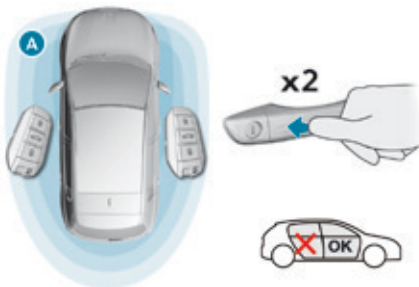

By the doors or tailgate:

- ☞ With the electronic key on your person in the recognition zone **A**, press with a finger or thumb on the door handle (at the markings) or on the locking control on the tailgate (right-hand side) to lock the vehicle.



- ☞ Within five seconds, press the door handle or the locking control on the tailgate (right-hand side) again to deadlock the vehicle.

- ! Accumulations (water, dust, grime, salt...) on the inner surface of the door handle may affect detection. If cleaning the inner surface of the door handle using a cloth does not restore detection, contact a PEUGEOT dealer or a qualified workshop. A sudden splash of water (stream of water, high pressure jet washer, ...) may be identified by the system as the desire to open the vehicle.

## Boot

### Opening using the key



- After unlocking the vehicle with the remote control, press this button and then open the boot.

### Opening using the "Keyless Entry and Starting" remote control

#### Complete unlocking



- Press this button, the **vehicle** is unlocked.

- Press the opening control, then raise the tailgate.

#### Selective unlocking

Complete unlocking is selected by default. This setting is done in the "**Driving assistance**" menu, then "**Vehicle settings**" and "**Vehicle access**".



- Press this button, the **boot** is unlocked.

- Press the opening control, then raise the tailgate.



Use this button for access to additional information.

### Opening using the "Keyless Entry and Starting" system

#### Complete unlocking



- With the electronic key on your person in the recognition zone **A**, press the opening control then raise the tailgate.

#### Selective unlocking

By default, complete unlocking is activated. This setting is done in the "**Driving assistance**" menu, then "**Vehicle settings**" and "**Vehicle access**".

When unlocking of the boot only is activated:

- ☞ With the electronic key in the recognition zone **A**, press the boot unlocking control to unlock just the tailgate, then raise the tailgate.

Unlocking is signalled by rapid flashing of the direction indicators for a few seconds.



Use this button for access to additional information.

## Closing

- ☞ Lower the tailgate using one of the interior grab handles.

If the tailgate is not closed correctly (the lock has two positions), with the **engine running** or **when moving** (speed above 6 mph (10 km/h)), a message appears for a few seconds.

## Locking with the "Keyless Entry and Starting" system



- ☞ With the electronic key in the recognition zone **A**, press the boot locking control to lock the vehicle.

Locking is signalled by rapid flashing of the direction indicators for a few seconds.

## Tailgate release

System allowing the mechanical unlocking of the boot in the event of a battery or central locking system malfunction.

## Unlocking

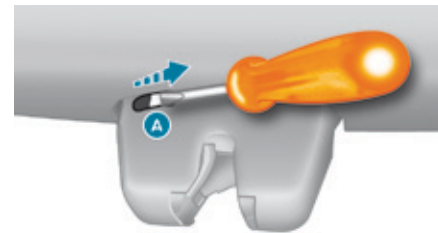

- ☞ Fold back the rear seats to gain access to the lock from inside the boot.
- ☞ Insert a small screwdriver into hole **A** of the lock to unlock the tailgate.
- ☞ Move the latch to the right.

## Locking after closing

If the fault persists after closing again, the boot will remain locked.



## Back-up key

### Unlocking / Locking using the integral key with Keyless Entry and Starting

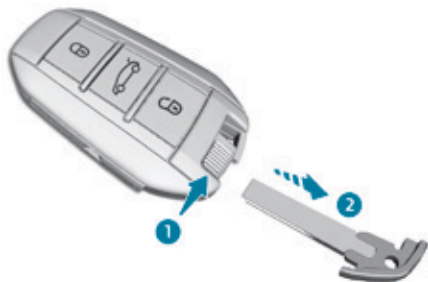

The integral key is used to lock and unlock the vehicle when the electronic key cannot operate:

- battery flat, vehicle battery discharged or disconnected, ...
  - vehicle located in an area with strong electromagnetic signals.
- ☞ Maintain a pull on button 1, to extract the integral key 2.

**i** If the alarm is activated, the audible signal triggered on opening a door with the key (integral with the remote control) will stop when the ignition is switched on.

#### Locking the driver's door



- ☞ Insert the integral key in the door lock, then turn it to the rear.

#### Unlocking the driver's door

- ☞ Insert the integral key in the door lock, then turn it to the front.

**i** For more information on the **Child lock**, refer to the corresponding section.

#### Locking the passenger doors

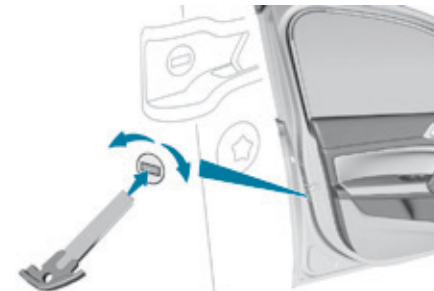

- ☞ Open the doors.
- ☞ For the rear doors, check that the child lock is not on.
- ☞ Insert the integral key in the latch located on the edge of the door and turn it an eighth of a turn to the right for the right-hand door, and to the left for the left-hand door.
- ☞ Close the doors and check that the vehicle has locked correctly from the outside.

#### Unlocking the passenger doors

- ☞ Pull the interior door opening control.

## Changing the battery



Battery ref.: CR2032 / 3 volts.

This replacement battery is available from a PEUGEOT dealer or a qualified workshop. A message appears in the instrument panel screen when replacement of the battery is needed.

- ☞ Unclip the cover using a small screwdriver at the cutout.
- ☞ Lift off the cover.
- ☞ Remove the flat battery from its location.
- ☞ Fit the new battery into its location observing the original direction of fitment.
- ☞ Clip the cover onto the casing.



Do not throw the remote control batteries away, they contain metals which are harmful to the environment. Take them to an approved collection point.

## Remote control problem - reinitialisation

Following disconnection of the vehicle battery, replacement of the remote control battery or in the event of a remote control malfunction, you can no longer unlock, lock or locate your vehicle.



- ☞ Place the mechanical key (integral with the remote control) in the lock to unlock your vehicle.
- ☞ Remove the mat under 12 V socket.
- ☞ Place the electronic key in the housing provided.
- ☞ Switch on the ignition by pressing START/STOP.

The electronic key is fully operational again.

If the problem persists, contact a PEUGEOT dealer or a qualified workshop as soon as possible.

## **! Lost keys, remote control, electronic key**

Visit a PEUGEOT dealer with the vehicle's registration certificate, your personal identification documents and if possible, the label bearing the key code.

The PEUGEOT dealer will be able to retrieve the key code and the transponder code required to order a new key

### **Remote control**

The high frequency remote control is a sensitive system; do not operate it while it is in your pocket as there is a possibility that it may unlock the vehicle, without you being aware of it.

Do not repeatedly press the buttons of your remote control out of range and out of sight of your vehicle. You run the risk of stopping it from working and the remote control would have to be reinitialised.

The remote control does not operate when the key is in the ignition, even when the ignition is switched off.

### **Locking the vehicle**

Driving with the doors locked may make access to the passenger compartment by the emergency services more difficult in an emergency.

As a safety precaution (with children on board), remove the key from the ignition or take the electronic key when you leave the vehicle, even for a short time.

### **Electrical interference**

The Keyless Entry and Starting electronic key may not operate if close to certain electronic devices: telephone, laptop computer, strong magnetic fields, ...

### **Anti-theft protection**

Do not make any modifications to the electronic engine immobiliser system; this could cause malfunctions.

Don't forget to turn the steering to engage the steering lock.

### **When purchasing a second-hand vehicle**

Have the key codes memorised by a PEUGEOT dealer, to ensure that the keys in your possession are the only ones which can start the vehicle.

## Locking/ unlocking from the inside

### Automatic central locking of the doors

The doors can lock automatically while driving (speed above 6 mph (10 km/h)).



To activate or deactivate this function, press and hold the button until a message appears in the screen.

**i** After unlocking, if no door is opened within 30 seconds, the doors lock again automatically.

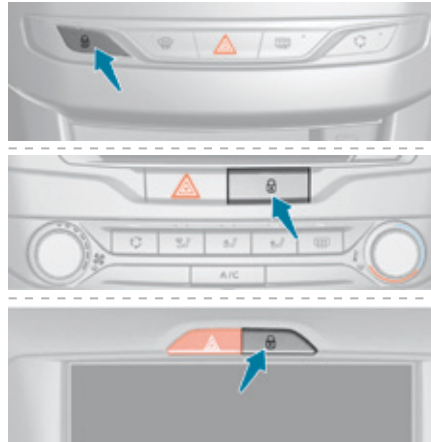

 Press the button.  
This allows the doors and the boot to be locked or unlocked.

**!** Driving with the doors locked may make access to the passenger compartment by the emergency services more difficult in an emergency.

**!** If the vehicle is deadlocked or locked with the remote control or the door handles, the button is not active. In this case, use the key or the remote control to unlock.

**i** When carrying large objects with the boot open, you can press this button to lock just the doors.  
When locking from inside, the door mirrors do not fold.

## Alarm



System which protects and provides a deterrent against theft and break-ins.

It provides the following types of monitoring:

### Exterior perimeter

The system checks for opening of the vehicle. The alarm is triggered if anyone tries to open a door, the boot or the bonnet.

### Interior volumetric

The system checks for any variation in the volume in the passenger compartment. The alarm is triggered if anyone breaks a window, enters the passenger compartment or moves inside the vehicle.

**i** For vehicles fitted with the system, the volumetric monitoring is not compatible with programmed temperature pre-conditioning.

### Tilt\*

The system checks for movement of the vehicle on the ground.

The alarm is triggered if the vehicle is lifted, moved or collided with.

### **!** Self-protection function

The system checks for the disconnection of any of its components. The alarm is triggered if the battery, the button or the wires of the siren are disconnected or damaged.

For all work on the alarm system, contact a PEUGEOT dealer or a qualified workshop.

## Locking the vehicle with full alarm system

### Activation

☞ Switch off the ignition and get out of the vehicle.



☞ Lock the vehicle using the remote control.

or

☞ Lock the vehicle using the "Keyless Entry and Starting" system.

The monitoring system is active: the indicator lamp in the button flashes once per second and the direction indicators come on for about 2 seconds.

After an instruction to lock the vehicle using the remote control or the Keyless Entry and Starting system, the exterior perimeter monitoring is activated after a delay of 5 seconds, the interior volumetric monitoring after 45 seconds.

If an opening (door, boot, bonnet...) is not closed fully, the vehicle is not locked but monitoring will be activated after a delay of 45 seconds.

\* On GT and GTi versions.

## Deactivation



☞ Press this unlocking button on the remote control.

or

☞ Unlock the vehicle using the "Keyless Entry and Starting" system.

The monitoring system is deactivated: the indicator lamp in the button goes off and the direction indicators flash for about 2 seconds.

**i** If the vehicle self-locks automatically (occurs after 30 seconds if a door or the boot is not opened), the monitoring system is not reactivated automatically. To reactivate the system, it is necessary to unlock and then lock the vehicle again, using the remote control or the "Keyless Entry and Starting" system.

## Locking the vehicle with exterior perimeter monitoring only

Deactivate the interior volumetric monitoring (and tilt monitoring if your vehicle has it) to avoid unwanted triggering of the alarm in certain cases such as:

- occupant(s) present in the vehicle,
- leaving a window partially open,
- washing your vehicle,
- changing a wheel,
- towing your vehicle,
- transport on a ferry.

## Deactivating the volumetric monitoring

The tilt alarm is deactivated as well, if your vehicle has it.



☞ Switch of the ignition and within ten seconds press this button until its indicator lamp is on fixed.

☞ Get out of the vehicle.



☞ Immediately lock the vehicle using the remote control or the "Keyless Entry and Starting" system.

Only the exterior perimeter protection system is active: the indicator lamp in the button flashes once per second.

To be taken into account, this deactivation must be done every time the ignition is switched off.

## Reactivating the volumetric monitoring

The tilt alarm is reactivated as well, if your vehicle has it.



- ☞ Deactivate the exterior perimeter monitoring by unlocking the vehicle using the remote control or the Keyless Entry and Starting system.

The indicator lamp in the button goes off.



- ☞ Reactivate the full alarm system by locking the vehicle using the remote control or the "Keyless Entry and Starting" system.

The indicator lamp in the button flashes once per second again.

## Triggering of the alarm

This is indicated by sounding of the siren and flashing of the direction indicators for thirty seconds.

The monitoring functions remain active until the alarm has been triggered eleven times in succession.



- When the vehicle is unlocked using the remote control or the Keyless Entry and Starting system, rapid flashing of the indicator lamp in the button informs you that the alarm was triggered during your absence. When the ignition is switched on, this flashing stops immediately.

## Failure of the remote control

To deactivate the monitoring functions:

- ☞ Unlock the vehicle using the key (integral with the remote control) in the driver's door lock.
- ☞ Open the door; the alarm is triggered.
- ☞ Switch on the ignition; the alarm stops. The indicator lamp in the button goes off.

## Locking the vehicle without activating the alarm

- ☞ Lock or deadlock the vehicle using the key (integral with the remote control) in the driver's door lock.

## Operating fault



- When the ignition is switched on, fixed illumination of the indicator lamp in the button indicates a fault in the system.

Have it checked by a PEUGEOT dealer or a qualified workshop.

## Automatic activation

This function is either not available, an option or is standard.

2 minutes after the last door or the boot is closed, the system is activated automatically.

- ☞ To avoid triggering the alarm on entering the vehicle, first press the unlocking button on the remote control or unlock the vehicle using the Keyless Entry and Starting system.

## Electric windows



1. Front left.
2. Front right
3. Rear right.
4. Rear left.
5. Deactivating the rear electric window switches.

**i** Maintaining the locking action (on the key or the remote control) closes the windows automatically.

### Manual operation

To open or close the window, press or pull the switch gently. The window stops as soon as the switch is released.

### Automatic one-touch operation (depending on version)

To open or close the window, press or pull the switch fully: the window opens or closes completely when the switch is released. Pressing the switch again stops the movement of the window.

The electric window switches remain operational for approximately one minute after the key has been removed. Once this time has elapsed, the electric windows will not operate. To reactivate them, switch the ignition on again.

### Safety anti-pinch (depending on version)

When the window rises and meets an obstacle, it stops and immediately partially lowers again.

In the event of unwanted opening of the window when closing automatically, press the switch until the window opens completely, then pull the switch immediately until the window closes. Continue to hold the switch for approximately one second after the window has closed.

The safety anti-pinch function is not active during this operation.



## Deactivating the rear window controls



For the safety of your children, press this switch to prevent operation of the windows of the rear doors, irrespective of their position.

With the indicator lamp on, the rear switches are deactivated.

With the indicator lamp off, the switches are active.

## Reinitialising the electric windows

Following reconnection of the battery, the safety anti-pinch function must be reinitialised. The safety anti-pinch is not active during these operations:

- lower the window completely, then raise it, it will rise in steps of a few centimetres each time the switch is pressed. Repeat the operation until the window closes completely,
- press and hold the switch upwards for at least one second after reaching this position, window closed.



Always remove the key when leaving the vehicle, even for a short time.

In the event of contact during operation of the windows, you must reverse the movement of the window. To do this, press the switch concerned.

When operating the passenger electric window switches, the driver must ensure that no one is preventing correct closing of the windows.

The driver must ensure that the passengers use the electric windows correctly.

Be aware of children when operating the windows.

## PEUGEOT i-Cockpit

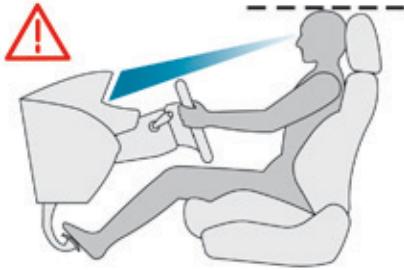

Before taking to the road and to make the most of the special ergonomics of the PEUGEOT i-Cockpit, carry out these adjustments in the following order:

- head restraint height,
- backrest angle,
- seat cushion height,
- seat longitudinal position,
- steering wheel reach and then height
- the interior and door mirrors.

**i** Once these adjustments have been made, ensure that from your driving position you can see the "head-up" instrument panel clearly, over the reduced diameter steering wheel.

**!** Before moving the seat backwards, ensure that there is nothing that might prevent the full travel of the seat, so as to avoid the risk of jamming the seat caused by the presence of objects on the floor behind the seat or rear passengers. If the seat jams, stop the movement immediately.

## Steering wheel adjustment

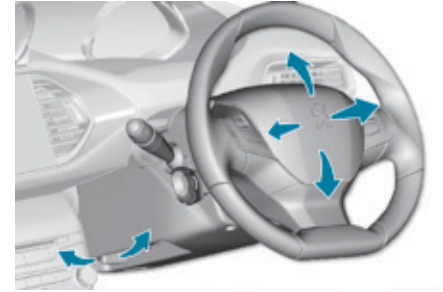

- ☞ **When stationary**, lower the control lever to release the steering wheel adjustment mechanism.
- ☞ Adjust the height and reach to suit your driving position.
- ☞ Pull the control lever to lock the steering wheel adjustment mechanism.

**!** As a safety precaution, these operations should only be carried out while the vehicle is stationary.

# Front seats with manual adjustments

As a safety measure, seat adjustments should only be carried out when stationary.

## Forwards-backwards

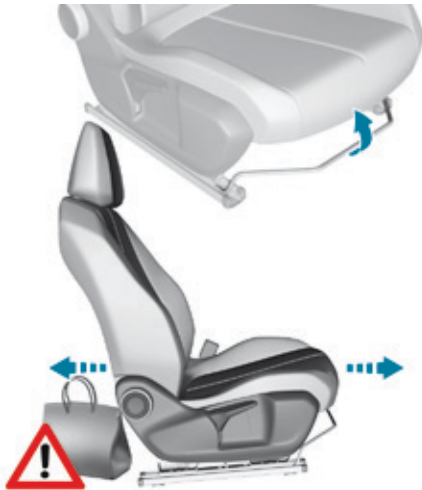

- ☞ Raise the control and slide the seat forwards or backwards.

## Height



- ☞ Pull the control upwards to raise or push it downwards to lower, as many times as required, to obtain the position required.

## Backrest angle

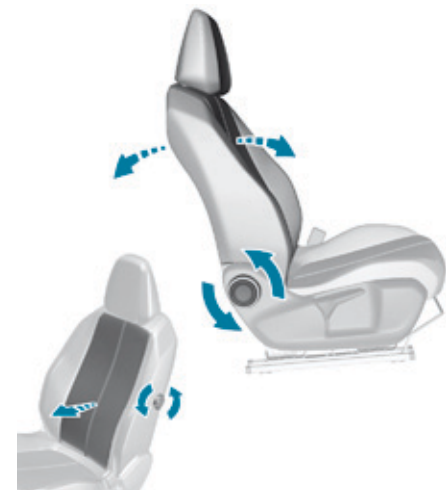

- ☞ Turn the knob to adjust the backrest.

## Lumbar

- ☞ Turn the knob manually to obtain the desired level of lumbar support.

**!** Before moving the seat backwards, ensure that there is nothing that might prevent the full travel of the seat, so as to avoid the risk of jamming the seat caused by the presence of objects on the floor behind the seat or rear passengers. If the seat jams, stop the movement immediately.



# 3

## Additional adjustments

### Heated seats



With the engine running, the front seats can be heated separately.

- ☞ Use the adjustment thumbwheel to switch on and select the desired level of heating:
  - 0:** Off.
  - 1:** Low.
  - 2:** Medium.
  - 3:** High.

☘ Do not use the function if the seat is not occupied.  
Reduce the level of heating as soon as possible.  
Once the seat and passenger compartment are at a comfortable temperature, you can switch off the function; reducing electric current consumption also reduces fuel consumption.

! Prolonged use at the highest setting is not recommended for those with sensitive skin.  
There is a risk of burns for those that do not have normal perception of heat (illness, taking medicines, ...).  
There is a risk of overheating the system if material with insulating properties is used, such as cushions or seat covers.  
Do not use the system:

- if wearing damp clothing,
- if child seats are fitted.

To avoid breaking the heating element in the seat:

- do not place heavy objects on the seat,
- do not kneel or stand on the seat,
- do not place sharp objects on the seat,
- do not spill liquids onto the seat.

To avoid the risk of short-circuit:

- do not use liquid products for cleaning the seat,
- never use the heating function when the seat is damp.

## Head restraint height

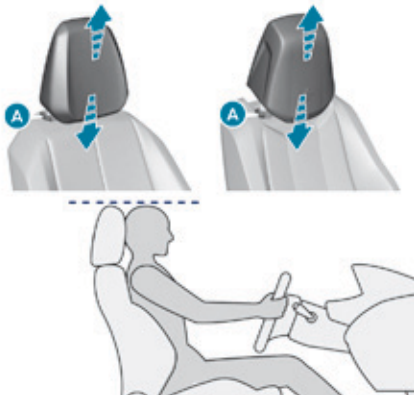

- ☞ To raise the head restraint, pull it upwards.
- ☞ To remove the head restraint, press the lug **A** and pull the head restraint upwards.
- ☞ To put the head restraint back in place, engage the head restraint stems in the openings keeping them in line with the seat backrest.
- ☞ To lower the head restraint, press the lug **A** and the head restraint at the same time.

**!** The head restraint is fitted with a frame with notches which prevents it from lowering; this is a safety device in case of impact.

**The adjustment is correct when the upper edge of the head restraint is level with the top of the head.**

Never drive with the head restraints removed; they must be in place and adjusted correctly.

## Electric lumbar adjustment



- ☞ Press the control to obtain the desired lumbar support.

# 3

## Massage function

This system provides the occupants of the front seats with a lumbar massage. It only operates when the engine is running or in STOP mode of the Stop & Start system.

### Activation / Deactivation



☞ Press this button.

Its indicator lamp comes on and the massage function is activated for a period of 1 hour.

During this time, massage is performed in 6 cycles of 10 minutes (6 minutes of massage followed by 4 minutes break).

After one hour, the function is deactivated, the indicator lamp goes off.

Deactivate the massage function by pressing this button; its indicator lamp goes off.

### Adjustment of intensity



☞ Press this button to adjust the intensity of the massage.  
Two levels of massage are available.



## Rear seats (hatchback)

Rear seats with fixed one-piece cushion and 1/3 - 2/3 split backrests which can be folded individually to adapt the load space in the boot.

### Folding the backrest



- ☞ Move the corresponding front seat forward if necessary.
- ☞ Check that the corresponding outer seat belt is positioned correctly against the backrest and buckle it.
- ☞ Place the head restraints in the low position.

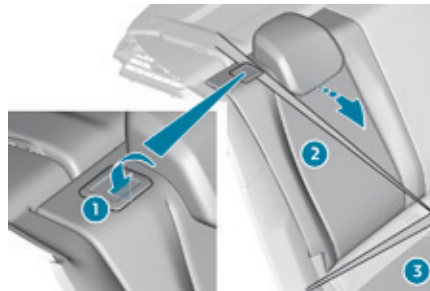

- ☞ Press control 1 to release the seat backrest 2.
- ☞ Fold the seat backrest 2 on to the cushion 3.

**!** When folding the seat, the centre seat belt should not be fastened, but laid out flat on the seat

**i** The rear seat cushion does not fold, just the seat backrest can be folded to increase the boot loading space.

### Repositioning the seat backrest



- ☞ Straighten the seat backrest 2 and secure it.
- ☞ Check that the red indicator, located next to the control 1, is no longer visible.
- ☞ Unbuckle and reposition the outer seat belt on the side of the backrest.

**!** When repositioning the seat backrest, take care not to trap the seat belts.

# 3

## Rear seats (SW)

1/3 - 2/3 split rear seats which can be folded to vary the boot load space.

### Folding the seat from the boot

Each section of the seat (1/3 or 2/3) has its own control to release the seat backrest from inside the boot.



- ☞ Check that nothing is preventing the seat backrest from folding (seat belts, ...) and that no object might interfere with the seat manoeuvre (above as well as below).
- ☞ Place the head restraints in the low position.



- ☞ Pull the control from inside the boot, the seat backrest folds onto the cushion.

### Folding the seat from the rear

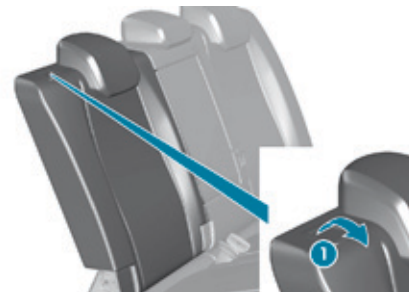

- ☞ Check that nothing is preventing the seat backrest folding and that no object might interfere with the seat manoeuvre (above as well as below).
- ☞ Move the corresponding front seat forwards if necessary.
- ☞ Check that the seat belt is positioned correctly on the side of the seat backrest.
- ☞ Place the head restraints in the low position.



- ☞ Pull the control 1 forwards, the seat backrest folds onto the cushion.

## Returning the seat back to its original position

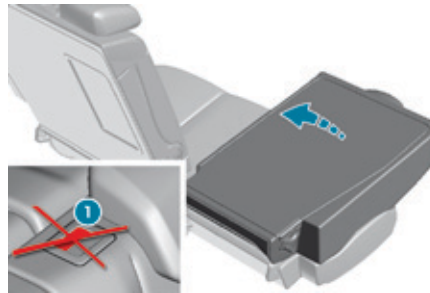

- ☞ Put the seat backrest in the upright position and secure it.
- ☞ Check that the red indicator, located at the control 1, is no longer visible.
- ☞ Refit the head restraints or put them back in place.

**!** When returning the rear seat back to its original position, take care not to trap the seat belts and ensure that their buckles are positioned correctly.

## Outer rear seat head restraints

These have one position for use (up) and a stowed position (down). They can be removed and are interchangeable.

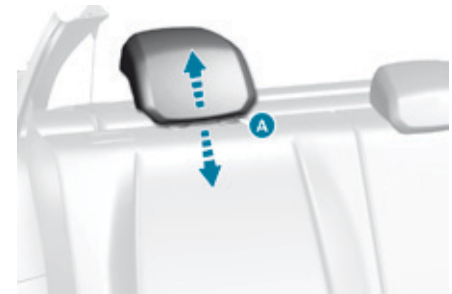

To remove a head restraint:

- ☞ pull the head restraint upwards to the stop,
- ☞ then, press the lug A.

**i** The centre head restraint is not adjustable.

**!** Never drive with the head restraints removed; they must be in place and correctly adjusted.

## Interior fittings

1. Refrigerated glove box equipped with a ventilation nozzle
2. 12V accessory socket (120 W)  
Observe the maximum power rating to avoid damaging your accessory.
3. USB port
4. Jack auxillary socket
5. Cup holder (depending on version)
6. Storage (depending on version)
7. Storage - Retractable cup holder  
Tip the carrier for access to the cup holder.
8. Front armrest

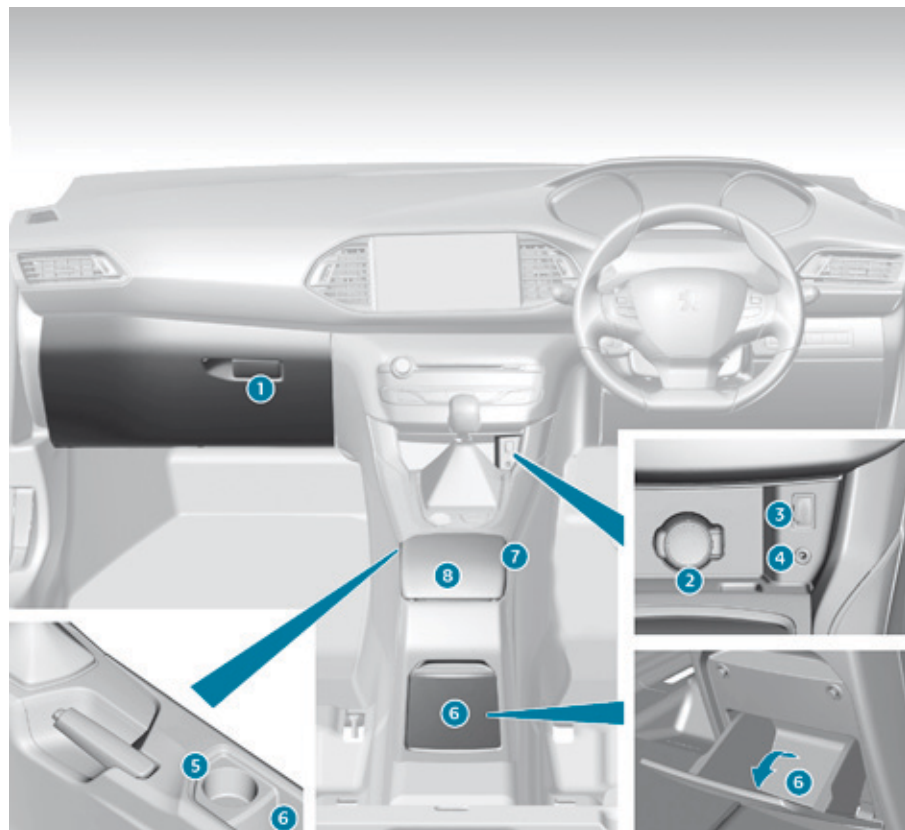

# Mats

## Fitting

When fitting the mat for the first time, on the driver's side use only the fixings provided in the wallet attached.

The other mats are simply placed on the carpet.

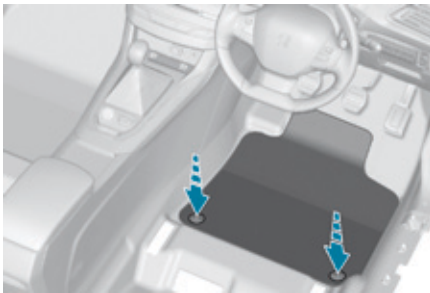

## Removal

To remove the mat on the driver's side:

- ☞ move the seat as far back as possible,
- ☞ unclip the fixings,
- ☞ remove the mat.

## Refitting

To refit the mat on the driver's side:

- ☞ position the mat correctly,
- ☞ refit the fixings by pressing,
- ☞ check that the mat is secured correctly.



To avoid any risk of jamming of the pedals:

- only use mats which are suited to the fixings already present in the vehicle; these fixings must be used,
- never fit one mat on top of another.

The use of mats not approved by PEUGEOT may interfere with access to the pedals and hinder the operation of the cruise control / speed limiter.

The mats approved by PEUGEOT have two fixings located below the seat.

## Front armrest

The height and longitudinal position of the armrest cover can be adjusted for greater comfort.

### Height adjustment

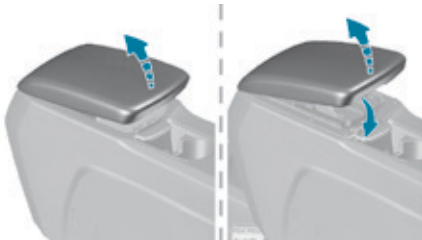

- ☞ Raise the cover to the required position (low, intermediate or high).
- ☞ If you raise the cover slightly beyond the high position, guide it when lowering it to the low position.

### Longitudinal adjustment



- ☞ Slide the cover fully forwards or rearwards.

### Storage



- ☞ Raise the lever.
- ☞ Raise the cover fully.

## 12 V accessory socket



- ☞ To connect a 12 V accessory (maximum power: 120 Watts), lift the cover and connect a suitable adaptor.

**!** Observe the maximum power rating to avoid damaging your accessory.

**!** The connection of an electrical device not approved by PEUGEOT, such as a USB charger, may adversely affect the operation of vehicle electrical systems, causing faults such as poor telephone reception or interference with displays in the screens.

## USB port



It allows the connection of a portable device, such as a digital audio player of the iPod® type or a USB memory stick.

It reads the audio files which are transmitted to your audio system and played via the vehicle's speakers.

You can manage these files using the steering mounted controls or the audio system.

- i** When a USB port is used, the portable device charges automatically. While charging, a message is displayed if the current consumption of the portable device exceeds the power rating of the port. For more information on using this equipment, refer to the **Audio and telematics** section.

## Jack auxiliary socket



It permits the connection of a portable device so that you can listen to your music files via the vehicle's speakers.

The management of the files is done using your portable device.

- i** For more information on the use of this equipment, refer to the **Audio and telematics** section.

## Rear armrest



- ☞ Lower the rear armrest for a more comfortable position.

It may be fitted with cup holders and also gives access to the ski flap.

## Ski flap

It allows long objects to be carried in the vehicle.

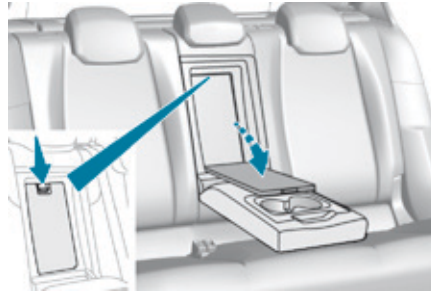

- ☞ Lower the armrest.
- ☞ Press the flap opening control.
- ☞ Lower the flap.
- ☞ Load the objects from inside the boot.

**!** Do not leave the flap open when not carrying long objects in the vehicle.



## Boot fittings (hatchback)

1. Rear parcel shelf
2. Boot floor  
Raise the floor for access to the storage.
3. Storage wells  
in which are stowed:
  - the towing eye,
  - the temporary puncture repair kit,
  - the spare wheel, depending on trim level, an option or standard.
4. Stowing rings
5. Strap (depending on version)

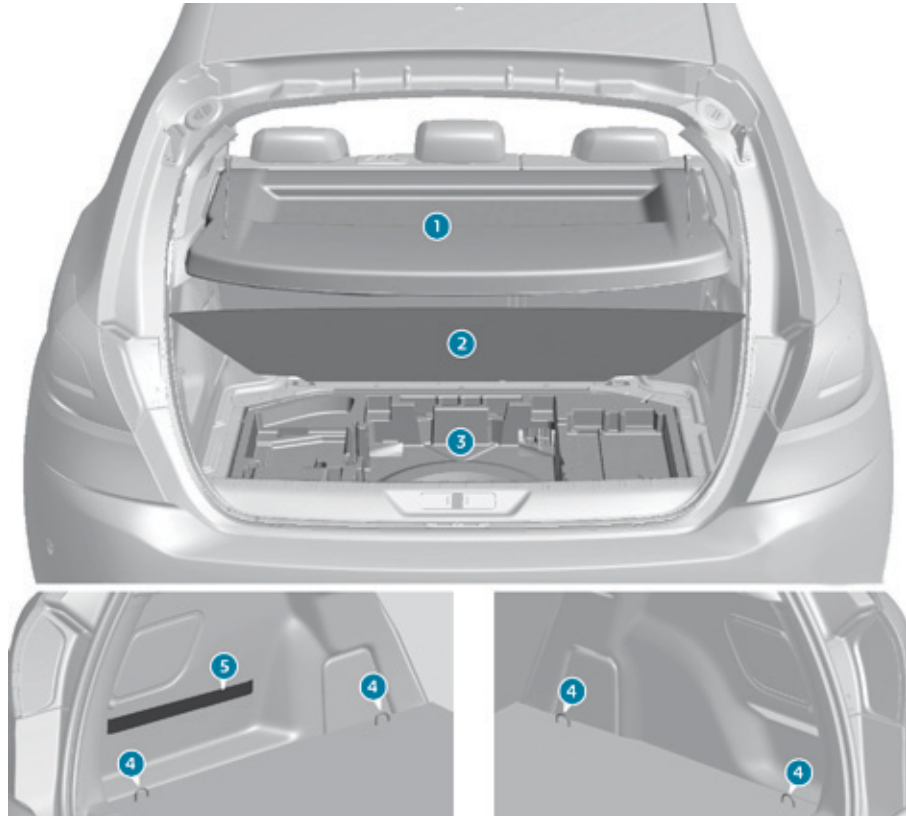

## Boot fittings (SW)

1. Boot lamp
2. Rear seat folding controls
3. 12 V accessory socket (120 W max)
4. Removable storage boxes  
Pull up to unclip them.
5. Storage wells, in which are stowed:
  - the towing eye,
  - the temporary puncture repair kit,
  - the spare wheel, depending on trim level, an option or standard.
6. Luggage cover  
(see corresponding section)

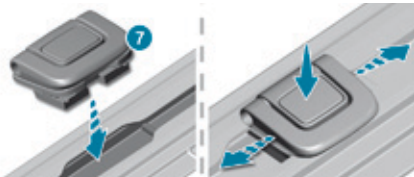

7. Eyes for fixing a net (to restrain luggage)  
(depending on version)
  - ☞ Extract the eyes one at a time then slide them into the oblong housing.
  - ☞ While pressing the button, move the eye to the desired position.
  - ☞ Observe the direction of fitting (eyes in the vertical position towards the outside of the vehicle).

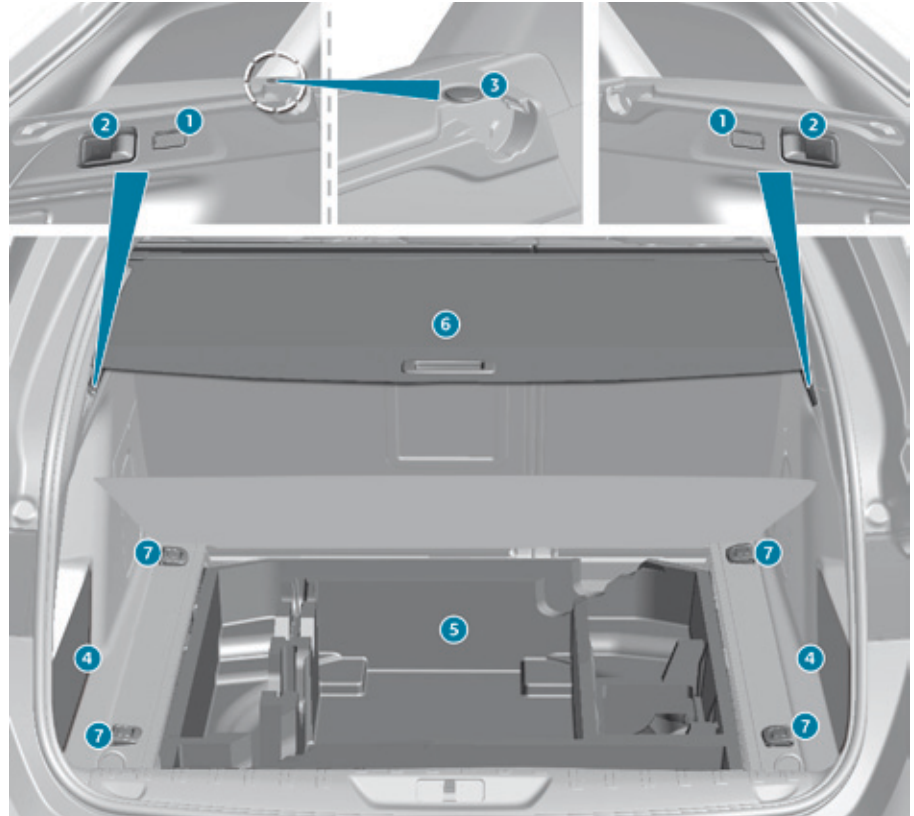

## Luggage cover, roller blind (SW)

### To reel in

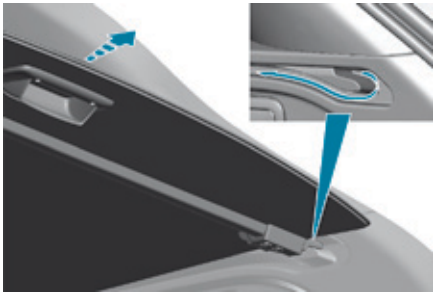

- ☞ Remove the roller guide from the rails in the boot pillars.
- ☞ Release the roller blind, it reels in automatically.

### To remove



- ☞ Place a hand on the left **under** the luggage cover.
- ☞ Turn the end of the reel towards the front (clockwise) to release it.
- ☞ Repeat the operation on the right (anti-clockwise).

### Storage

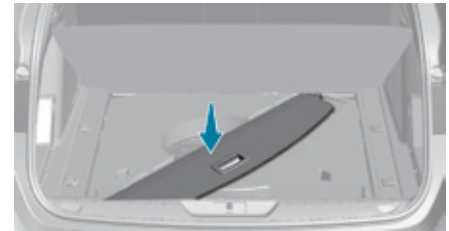

A recess in the floor well, under the boot carpet, allows the luggage cover to be stowed diagonally.

- i** This recess is not available with the bass woofer unit.

# 3

## To install



- ☞ Position the left and then right-hand ends of the luggage cover in their respective housings.
- ☞ Place your hands **on** the roller then turn the assembly to the rear to secure it.
- ☞ Unreel the roller blind until it locks on the rear pillar.

## High load (SW)

### Luggage retaining net

This allows the use of the entire loading volume up to the roof:

- behind the front seats (row 1) when the rear seats are folded.
- behind the rear seats (row 2).



#### Row 1

- ☞ Fold the rear seats.
- ☞ Remove the cover on each side of the roof.
- ☞ Position the net's upper hooks in the roof.
- ☞ Attach the bottom of the net to the fixings located at the seat belt mountings.
- ☞ Pull on the straps to stretch the net.

Once fitted, the net does not prevent folding of the rear seat backrests.

#### Row 2

- ☞ Remove the cover on each side of the roof.
- ☞ Position the net's upper hooks in the roof.
- ☞ Attach the bottom of the net to the rings located either side of the boot carpet or on the boot rails (depending on trim level).
- ☞ Pull on the straps to stretch the net.

# Heating and Ventilation

## Air intake

The air circulating in the passenger compartment is filtered and originates either from the outside via the grille located at the base of the windscreen or from the inside in air recirculation mode.

## Controls

The incoming air follows various routes depending on the controls selected by the driver, the front passenger and rear passengers, according to the level of equipment.

The temperature control enables you to obtain the level of comfort required by mixing the air of the various circuits.

The air distribution control enables you to select the air vents used in the passenger compartment by the combined use of the associated buttons.

The air flow control enables you to increase or reduce the speed of the ventilation fan. Depending on your vehicle, the controls are accessible in the "**Air conditioning**" menu of the touch screen or are grouped together on control panel on the centre console.

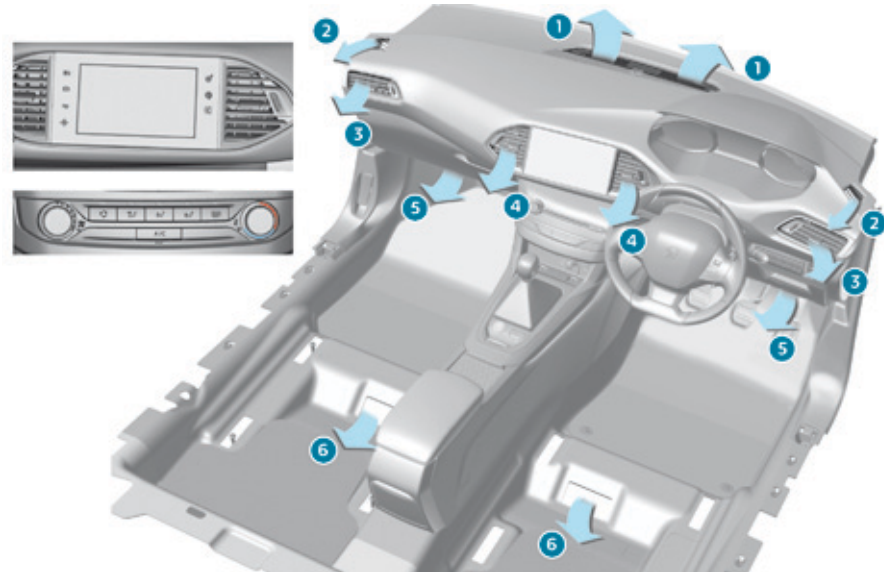

## Air distribution

1. Windscreen demisting/defrosting vents.
2. Front side window demisting/defrosting vents.
3. Side adjustable air vents.
4. Central adjustable air vents.
5. Air outlets to the front footwells.
6. Air outlets to the rear footwells.

## Recommendations for ventilation and air conditioning

- i** In order for these systems to be fully effective, follow the operation and maintenance guidelines below:
- ☞ To obtain an even air distribution, take care not to obstruct the exterior air intake grilles located at the base of the windscreen, the nozzles, the vents and the air outlets, as well as the air extractor located in the boot.
  - ☞ Do not cover the sunshine sensor, located on the dashboard; this is used for regulation of the air conditioning system.
  - ☞ Operate the air conditioning system for at least 5 to 10 minutes, once or twice a month to keep it in perfect working order.
  - ☞ Ensure that the passenger compartment filter is in good condition and have the filter elements replaced regularly.  
We recommend the use of a combined passenger compartment filter. Thanks to its special active additive, it contributes to the purification of the air breathed by the occupants and the cleanliness of the passenger compartment (reduction of allergic symptoms, bad odours and greasy deposits).
  - ☞ To ensure correct operation of the air conditioning system, you are also advised to have it checked regularly as recommended in the warranty and maintenance record.
  - ☞ If the system does not produce cold air, switch it off and contact a PEUGEOT dealer or a qualified workshop.

When towing the maximum load on a steep gradient in high temperatures, switching off the air conditioning increases the available engine power and so improves the towing ability.

- i** If after an extended stop in sunshine, the interior temperature is very high, first ventilate the passenger compartment for a few moments.  
Put the air flow control at a setting high enough to quickly change the air in the passenger compartment.  
The air conditioning system does not contain chlorine and does not present any danger to the ozone layer.

- i** The condensation created by the air conditioning results in a discharge of water under the vehicle which is perfectly normal.

### **i** Stop & Start

The heating and air conditioning systems only work when the engine is running.

To maintain a comfortable temperature in the passenger compartment, you can temporarily deactivate the Stop & Start system.

For more information on **Stop & Start**, refer to the corresponding section.

# Manual air conditioning

The air conditioning system only operates with the engine running.



## Temperature adjustment



- Turn the dial from blue (cold) to red (hot) to adjust the temperature to your requirements.

## Air flow adjustment



- Turn the dial to obtain a comfortable air flow.

**i** If you put the air flow control in the **minimum** position (system off), the temperature is no longer controlled. However, a slight flow of air can still be felt, resulting from the movement of the vehicle.

## Air distribution adjustment



Windscreen and side windows.



Central and side vents.



Footwells.

The air distribution can be adapted by adding the corresponding buttons.

## Air conditioning On / Off

**A/C**

The air conditioning is designed to operate effectively in all seasons, with the windows closed.

It enables you to:

- lower the temperature, in summer,
- increase the effectiveness of the demisting in winter, above 3°C.

### Switching on

- Press this button; its indicator lamp comes on.

**i** The air conditioning does not operate when the air flow adjustment is set to off.

To obtain cool air more quickly, you can use interior air recirculation for a few moments. Then return to the intake of exterior air.

### Switching off

- Press this button again; its indicator lamp goes off.

Switching off the air conditioning may result in some discomfort (humidity, misting).

# Manual air conditioning (Touch screen)

The air conditioning system operates with the engine running.



Press the button for the "Air conditioning" menu to display the system controls page.

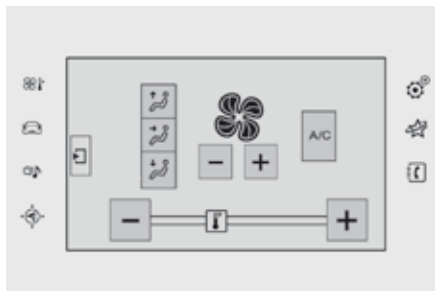

## Temperature adjustment



Press one of these buttons to reduce or increase the value.

## Air flow adjustment



Press one of these buttons to increase or decrease the speed of the air booster fan.

The air flow symbol (a fan) fills progressively according to the quantity of air wanted. By reducing the air flow to minimum, you are stopping ventilation.

**i** Avoid driving too long without ventilation (risk of misting and deterioration of air quality).

## Air distribution adjustment

These buttons are used to arrange the distribution of air in the passenger compartment by combining several air outlets.



Windscreen.



Central and side vents.



Footwells.

The air distribution can be adapted by using several buttons: illumination of the indicator lamp confirms the presence of fan boosted air in the direction indicated, the indicator lamp off indicates the absence of fan boosted air in the direction indicated.

For a uniform distribution of air in the passenger compartment, the three buttons can be activated simultaneously.



## Air conditioning On / Off

**A/C** The air conditioning is designed to operate effectively in all seasons, with the windows closed.

It enables you to:

- lower the temperature, in summer,
- increase the effectiveness of the demisting in winter, above 3°C.

### Switching on

**A/C** Press this button; its indicator lamp comes on.

**i** The air conditioning does not operate when the air flow adjustment is set to off.

To obtain cool air more quickly, you can use interior air recirculation for a few moments. Then return to the intake of exterior air.

### Switching off

**A/C** Press this button again; its indicator lamp goes off.

Switching off the air conditioning may result in some discomfort (humidity, misting).

## Dual-zone digital air conditioning (Touch screen)

This air conditioning system operates with the engine running, but the ventilation and its controls are available with the ignition on. Operation of the air conditioning and regulation of temperature, air flow and air distribution in the passenger compartment are automatic according to the temperature in the passenger compartment and the temperature setting.



Press the button for the "Air conditioning" menu to display the controls for the air conditioning system.

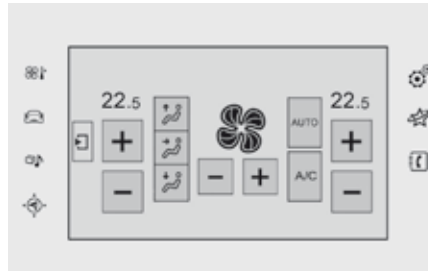

## Temperature adjustment

The driver and front passenger can each set the temperature.



- Press one of these buttons to increase the value.
- Press one of these buttons to decrease the value.

The value displayed corresponds to a level of comfort and not to a precise temperature. It is recommended that you avoid a difference between the left and right setting of more than 3.

## Automatic comfort programme

☞ Press the **"AUTO"** button to activate or deactivate the automatic mode of the air conditioning system.

When the indicator lamp in the button is on, the air conditioning system operates automatically: the system manages the temperature, air flow and air distribution in the passenger compartment in an optimum way depending on the comfort level you have selected.



It is possible to modulate the intensity of the automatic comfort programme by choosing one of three mode settings offered in the secondary page of the **"Air conditioning"** menu.

To change the current setting, shown by the green indicator lamp, press the button for the desired mode:



"Soft": provides soft and quiet operation by limiting air flow.



"Normal": offers the best compromise between a comfortable temperature and quiet operation (default setting).



"Fast": provides strong and effective air flow.

This setting is associated with AUTO mode only. However, on deactivation of AUTO mode, the indicator for the last setting remains on. Changing the setting does not reactivate AUTO mode if deactivated.

**i** In cold conditions and when the engine is cold, to limit distribution of cold air in the passenger compartment, the air flow will change gradually until the comfort setting is reached. On entering the vehicle, if the interior temperature is much colder or warmer than the comfort value setting, there is no need to alter the value displayed in order to reach the required level of comfort more quickly. The system automatically corrects the temperature difference.

## Resuming manual control

You can manually adjust one or more settings, while retaining automatic control of the other functions:

- air flow,
- air distribution.

As soon as you modify a setting, the indicator lamp in the "AUTO" button goes off.

**AUTO**  Press the "AUTO" button again to activate the automatic comfort programme again.

## Air flow adjustment



 Press one of these buttons to increase or decrease the speed of the booster fan.

The air flow symbol (a fan) is filled in progressively in relation to the quantity of air wanted.

By reducing the air flow to minimum, you are stopping ventilation.

"OFF" is displayed alongside the fan.

 Avoid driving for too long with the ventilation off (risk of misting and deterioration of air quality).

## Air distribution adjustment

You can modulate the distribution of air in the passenger compartment using these three buttons.

 Windscreen.

 Centre and side vents.

 Footwells.

Each press on a button activates or deactivates the function. The indicator lamp is on when the button is activated. For a uniform distribution in the passenger compartment, all three buttons can be pressed simultaneously.

In AUTO mode, the indicator lamps in all three buttons are off.

## Air conditioning On / Off

**A/C** The air conditioning is designed to operate efficiently in all seasons, with the windows closed.

It allows you:

- in summer, to lower the temperature,
- in winter, above 3 °C, to improve demisting.

### Switching on

☞ Press the "**A/C**" button to activate the air conditioning.

When the indicator lamp under the button is on, the air conditioning function is activated.

The air conditioning cannot operate when the air flow is set to off.

### Switching off

☞ Press the "**A/C**" button again to deactivate the air conditioning.

When the indicator lamp under the button is off, the air conditioning function is deactivated.

## Ventilation with "ignition on" function

With the ignition on, you can use the ventilation system and access the "**Air conditioning**" menu to adjust the **air flow** and **air distribution** in the passenger compartment. This function is available for a few minutes, depending on the state of charge of the battery of your vehicle.

This function does not activate the air conditioning.

You can make use of the residual heat in the engine to warm the passenger compartment using the temperature setting buttons.

## "Mono" function

The comfort setting for the passenger's side can be indexed to the driver's comfort setting (mono-zone).

From the secondary page of the "**Air conditioning**" menu:



- ☞ Press this button to activate / deactivate the "Mono" function. The indicator lamp in the button is on when the function is activated.

The function is deactivated automatically when the passenger uses their temperature setting buttons.

## Air intake / Air recirculation

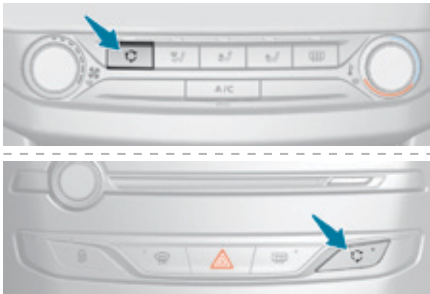

The intake of exterior air avoids misting of the windscreen and side windows.

The recirculation of interior air insulates the passenger compartment from exterior odours and smoke.

**i** This allows hot or cold air to be delivered quickly when required.



☞ Press this button to recirculate the interior air. Its indicator lamp comes on.

☞ Press the button again to allow fresh air into the passenger compartment. Its indicator lamp goes off.

**i** Return to exterior air intake as soon as possible to prevent deterioration of the air quality and the formation of mist.

## Front demist - defrost



These markings on the control panel indicate the control positions for rapid demisting or defrosting of the windscreen and side windows.

### With manual air conditioning



- ☞ Put the air flow, temperature and distribution controls to the dedicated marked position.
- ☞ Press the **"A/C"** button for air conditioning; the indicator lamp in the button comes on.

### With manual or dual-zone digital air conditioning (with the touch screen)



- ☞ Press this button to demist or defrost the windscreen and side windows as quickly as possible.

The system automatically manages the air conditioning, air flow and air intake, and provides optimum distribution towards the windscreen and side windows.

- ☞ To stop, press this button again or on **"AUTO"**.

The system reverts to the previous settings.

**i** With Stop & Start, when demisting has been activated, the STOP mode is not available.

## Rear screen demist - defrost

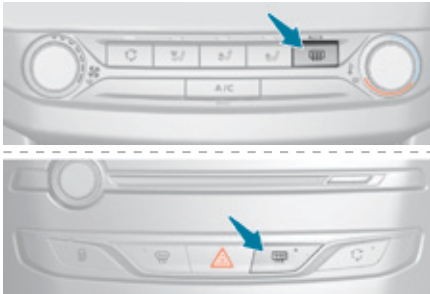

### Switching on



☞ Press this button to demist/defrost the rear screen and (depending on version) the door mirrors.

The indicator lamp associated with the button comes on.

### Switching off

The demisting/defrosting switches off automatically to prevent an excessive consumption of current.



☞ It is possible to stop the demisting/defrosting operation before it is switched off automatically by pressing the button again.

The indicator lamp associated with the button goes off.



Switch off the heating of the rear screen and door mirrors as soon as you judge it possible, as reducing the consumption of electrical current reduces fuel consumption.



The rear screen demist - defrost can only operate when the engine is running.

## Panoramic sunroof

Its electric blind improves thermal and acoustic comfort.

### Electric blind

#### Opening



- ☞ Press the back of the control without going beyond the point of resistance. The blind stops when you release the control.

#### Closing

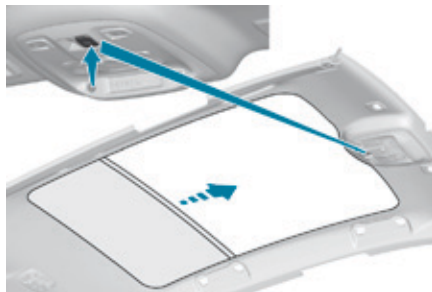

- ☞ Press the front of the control without going beyond the point of resistance. The blind stops when you release the control.

- ! You can also press or pull the control beyond the point of resistance: the blind opens or closes **completely** after you release the control. Operating the control again stops the movement of the blind.

#### ! Anti-pinch

If the blind encounters an obstacle, you should reverse the movement. Use the control to do this.

Remember to always switch off the ignition when leaving the vehicle, even for a short time.

When operating the control, the driver should ensure that there is nothing preventing movement of the blind.

The driver must ensure that passengers use the blind correctly.

Be aware of children when operating the blind.



# Courtesy lamps



1. Front courtesy lamp
2. Front map reading lamps



3. Rear courtesy lamp
4. Rear map reading lamps

## Front - rear courtesy lamps



In this position, the courtesy lamp comes on gradually:

- when the vehicle is unlocked,
- when the electronic key is removed from the reader,
- when opening a door,
- when the remote control locking button is used, in order to locate your vehicle.

It switches off gradually:

- when the vehicle is locked,
- when the ignition is switched on,
- 30 seconds after the last door is closed.



Permanently off.



Permanent lighting.



Depending on version, you can also switch the courtesy lamp on or off by pressing this button.

## Front - rear map reading lamps

- ☞ With the ignition on, press the corresponding switch.



Take care to avoid leaving anything in contact with the courtesy lamps.



With the "permanent lighting" mode, the lighting time varies according to the circumstances:

- with the ignition off, approximately ten minutes,
- in energy economy mode, approximately thirty seconds,
- with the engine running, unlimited.

## Footwell lighting

### Switching on



Its operation is identical to that of the courtesy lamps. The lamps come on when one of the doors is opened.

## Interior mood lighting

The dimmed passenger compartment lighting improves visibility in the vehicle when the light is poor.

### Switching on



At night, the illumination of the interior opening controls on the front doors comes on automatically when the sidelamps are switched on.

The interior mood lighting switches off automatically when the sidelamps are switched off.

The brightness of the interior mood lighting can be adjusted in the "**Driving assistance**" menu.

- ☞ Select the "**Vehicle settings**" menu.
- ☞ Check the "**Mood lighting**" line.



Press on the "**magnifying glass**" to adjust the brightness.

# Mirrors

## Door mirrors



Each fitted with an adjustable mirror glass providing the lateral rearward vision necessary for overtaking or parking. They can also be folded for parking in confined spaces.

### Demisting - Defrosting



Demisting-defrosting of the door mirrors operates with the engine running, by switching on the heated rear screen.

**i** For more information on **Demisting - Defrosting the rear screen**, refer to the corresponding section.

### Adjustment



- ☞ Move control **A** to the right or to the left to select the corresponding mirror.
- ☞ Move control **B** in all four directions to adjust.
- ☞ Return control **A** to the central position.

**!** As a safety measure, the mirrors should be adjusted to reduce the "blind spots". The objects observed are, in reality, closer than they appear. Take this into account in order to correctly judge the distance of vehicles approaching from behind.

### Folding

- ☞ From outside: lock the vehicle using the electronic key or the Keyless Entry and Starting system.
- ☞ From inside: with the ignition on, pull the control **A** in the central position rearwards.

**i** If the mirrors are folded using control **A**, they will not unfold when the vehicle is unlocked. Pull again on control **A**.

### Unfolding

- ☞ From outside: unlock the vehicle using the electronic key or the Keyless Entry and Starting system.
- ☞ From inside: with the ignition on, pull the control **A** in the central position rearwards.

**i** The folding and unfolding of the door mirrors using the remote control can be deactivated by a PEUGEOT dealer or a qualified workshop.

**i** If necessary, it is possible to fold the mirrors manually.

## Rear view mirror

Equipped with an anti-dazzle system, which darkens the mirror glass and reduces the nuisance to the driver caused by the sun, headlamps from other vehicles...

### Manual model

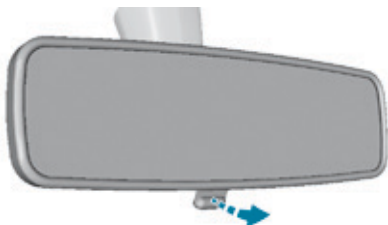

#### Adjustment

- ☞ Adjust the mirror so that the glass is directed correctly in the "day" position.

#### Day / night position

- ☞ Pull the lever to change to the "night" anti-dazzle position.
- ☞ Push the lever to change to the normal "day" position.

### Automatic "electrochrome" model



This system automatically and progressively changes between the day and night uses by means of a sensor, which measures the light from the rear of the vehicle.

**i** In order to ensure optimum visibility during your manoeuvres, the mirror lightens automatically when reverse gear is engaged.

# Lighting control stalk

Selection and control of the various front and rear lamps providing the vehicle's lighting and signalling.

## Main lighting

There are various lamps on the vehicle:

- sidelamps, to be seen,
- dipped beam headlamps to see without dazzling other drivers,
- main beam headlamps to see clearly when the road is clear,
- daytime running lamps at the front, to be seen during the day.

## Additional lighting

Other lamps are installed to fulfil the requirements of particular driving conditions:

- rear foglamps, to better signal the presence of the vehicle in foggy conditions,
- front foglamps, for better visibility in foggy conditions and to improve lighting at intersections and when parking,

## Automatic lighting functions

Various automatic lighting functions are also available depending on options:

- guide-me-home lighting (remotely),
- welcome lighting,
- daytime running lamps,
- automatic illumination of headlamps.

## Programming

You can adjust the settings of certain functions:

- guide-me-home lighting (remotely),
- welcome lighting.

# 4

**i** In some weather conditions (e.g. low temperature or humidity), the presence of misting on the internal surface of the glass of the headlamps and rear lamps is normal; it disappears after the lamps have been on for a few minutes.

## **i** Travelling abroad

### Halogen headlamps

If using your vehicle in a country that drives on the other side of the road, the headlamps must be adjusted to avoid dazzling on-coming drivers. Contact a PEUGEOT dealer or a qualified workshop.

### LED headlamps

The design of the LED headlamps allows you to use your vehicle in a country that drives on the other side of the road without any adjustment.



## Selection of main lighting mode

Turn the ring to align the desired symbol with the marking.

### Without AUTO lighting



**O** Lighting off (ignition off) / Front daytime running lamps (engine running).

**AUTO** Automatic illumination of headlamps.

 Sidelamps only.

 Dipped or main beam headlamps.

### With AUTO lighting



## Dipping the headlamps



Pull the stalk to switch the lighting between dipped and main beam headlamps.

In the lighting off and sidelamps modes, the driver can switch on the main beam headlamps temporarily ("headlamp flash") by maintaining a pull on the stalk.

## Display

Illumination of the corresponding indicator lamp in the instrument panel confirms the lighting switched on.

## Foglamps



### Rear foglamp only

The dipped or main beam headlamps must be on.

- ☞ To switch it on, turn the ring forwards.
- When the lighting is switched off automatically (with AUTO model), the foglamp goes off.
- ☞ To switch it off, turn the ring rearwards.



### Front and rear foglamps

The front and rear foglamps operate with the sidelamps or dipped beam on (in manual or auto mode).

Rotate and release the ring:

- ☞ forwards once to switch on the front foglamps,
- ☞ forwards again to switch on the rear foglamps,
- ☞ rearwards once to switch off the rear foglamps,
- ☞ rearwards again to switch off the front fog lamps.

When the headlamps switch off with automatic illumination of headlamps (AUTO model) or when the dipped beam headlamps are switched off manually, the foglamps and sidelamps remain on.

- ☞ Turn the ring rearwards to switch off the foglamps, the sidelamps will then switch off.

**!** In good or rainy weather, by both day and night, the front foglamps and the rear foglamps are prohibited. In these situations, the power of their beams may dazzle other drivers. They should only be used in fog or falling snow. In these weather conditions, you should switch on the foglamps and dipped beam headlamps manually, as the sunshine sensor may detect sufficient light. Do not forget to switch off the front and rear foglamps when they are no longer necessary.

**i** **Switching off the lighting when switching off the ignition**

When the ignition is switched off, all of the lamps switch off immediately, except for the dipped beam headlamps if automatic guide-me-home lighting is activated.

**i** **Switching on the lighting when switching on the ignition**

To reactivate the lighting control stalk, turn the ring **A** to position **"0"** - lighting off, then to the position of your choice. When the driver's door is opened, a temporary audible signal warns you that the vehicle's lighting is on. They switch off automatically after a period which depends on the state of charge of the battery (entry to energy economy mode).

## Front daytime running lamps (light-emitting diodes)



They come on automatically when the engine is started, when the lighting control stalk is in position **"0"** or **"AUTO"**.



## Automatic illumination of headlamps

When a low level of ambient light is detected by a sunshine sensor, the number plate lamps, sidelamps and dipped beam headlamps are switched on automatically, without any action on the part of the driver. They can also come on if rain is detected, at the same time as automatic operation of the windscreen wipers. As soon as the brightness returns to a sufficient level or after the windscreen wipers are switched off, the lamps are switched off automatically.

### Activation



- ☞ Turn the ring to the "AUTO" position. The activation of the function is accompanied by the display of a message.

### Deactivation

- ☞ Turn the ring to another position. Deactivation of the function is accompanied by the display of a message.

### Operating fault

**SERVICE** In the event of a malfunction of the sunshine sensor, the lighting comes on; this warning lamp is displayed in the instrument panel accompanied by an audible signal and/or a message.

Contact a PEUGEOT dealer or a qualified workshop.

**!** In fog or snow, the sunshine sensor may detect sufficient light. In this case, the lighting will not come on automatically. Do not cover the sunshine sensor, coupled with the rain sensor and located in the top of the windscreen behind the rear view mirror; the associated functions would no longer be controlled.

## Guide-me-home lighting Manual



Temporarily keeping the dipped beam headlamps on after the vehicle's ignition has been switched off makes the driver's exit easier when the light is poor.

### Switching on

- ☞ With the ignition off, "flash" the headlamps using the lighting stalk.
- ☞ Another "headlamp flash" switches the function off.

### Switching off

The manual guide-me-home lighting switches off automatically after a set time.

## Automatic

When the automatic illumination of headlamps function is activated (lighting control stalk in the "AUTO" position), under low ambient light the dipped beams headlamps come on automatically when the ignition is switched off.



Activation or deactivation, as well as the duration of the guide-me-home lighting, is set in the "Driving assistance" menu, then "Vehicle settings" in the secondary page.

## Exterior welcome lighting

The remote switching on of the lighting makes your approach to the vehicle easier in poor light. It is activated when the lighting control is in the "AUTO" position and the level of light detected by the sunshine sensor is low.

### Switching on



- Press the open padlock on the remote control or one of the front door handles with Keyless Entry and Starting.

The dipped beam headlamps and sidelamps come on; your vehicle is also unlocked.

### Switching off

The exterior welcome lighting switches off automatically after a set time, when the ignition is switched on or on locking the vehicle.

### Programming



The activation, deactivation and choice of welcome lighting duration are done in the "Driving assistance" menu then "Vehicle settings".

## Direction indicators



- Left: lower the lighting stalk passing the point of resistance.
- Right: raise the lighting stalk passing the point of resistance.

### Three flashes of the direction indicators

- Press briefly upwards or downwards, without going beyond the point of resistance; the direction indicators will flash 3 times.

## Door mirror spotlamps



To make your approach to the vehicle easier, these illuminate:

- the zones facing the driver's and passenger's doors,
- the zones forward of the door mirrors and rearward of the front doors.

## Switching on



When the courtesy lamp is in this position, the spotlamps come on automatically:

- when you unlock the vehicle,
- when you switch off the ignition,
- when you open a door,
- when you use the remote control to locate the vehicle.

## Switching off

They are timed to go off automatically.

## Headlamp beam height adjustment

### Manual adjustment of halogen headlamps



To avoid causing a nuisance to other road users, the beams of the halogen headlamps should be adjusted according to the load in the vehicle.

- 0** Driver or driver + front passenger.
- Driver + front passenger + rear passengers.
- 1** 5 people.
- 5 people + a load in the boot.
- 2** Driver + a load in the boot.

**i** The initial setting is position "0".

### Automatic adjustment of "Full LED" technology headlamps

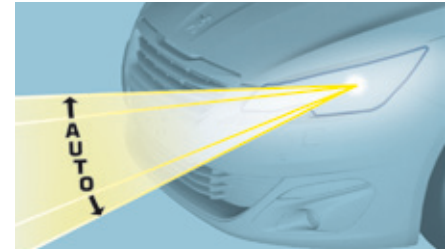

This system automatically adjusts the height of the beams from this type of headlamp, according to the load in the vehicle, to avoid causing a nuisance to other road users.

**SERVICE** If a fault occurs, this warning lamp comes on in the instrument panel, accompanied by a message and an audible signal.

The system then places the headlamp beams in the lowest position.

**!** Do not touch the "Full LED" technology headlamps. Risk of electrocution! Have the system checked by a PEUGEOT dealer or a qualified workshop.

# Wiper control stalk

## Programming

Your vehicle may also include some functions that can be configured:

- automatic rain sensitive windscreen wipers,
- rear wiping on engaging reverse gear.

**i** In wintry conditions, remove snow, ice or frost present on the windscreen, around the wiper arms and blades and the windscreen seal, before operating the wipers.

**!** Do not operate the wipers on a dry windscreen. Under extremely hot or cold conditions, ensure that the wiper blades are not stuck to the windscreen before operating the wipers.

## Manual controls



The wipers are controlled directly by the driver.

### With manual wiping (intermittent)



### With AUTO wiping



## Windscreen wipers

Wiping speed control stalk: raise or lower the stalk to the desired position.

- 2** Fast wipe (heavy rain).
- 1** Normal wipe (moderate rain).
- Int** Intermittent wipe (proportional to the speed of the vehicle).
- 0** Park.
- ↓** Single wipe (press downwards or pull the stalk briefly towards you, then release).
- or
- AUTO ↓** Automatic wiping (press down, then release).  
Single wipe (pull the stalk briefly towards you).

## Rear wiper



Rear wiper selection ring:



Park.



Intermittent wipe.



Wash-wipe (set duration).

## Reverse gear

When reverse gear is engaged, the rear wiper will come into operation automatically if the windscreen wipers are operating. Activation or deactivation of this automatic function can be set in the touch screen.



Select the "**Driving assistance**" menu, then "**Vehicle settings**".



This function is activated by default.



If a significant accumulation of snow or ice is present, or when using a bicycle carrier on the boot, deactivate the automatic rear wiper.

## Windscreen and headlamp wash



4

Pull the windscreen wiper stalk towards you. The screenwash then the wipers operate for a fixed period.

The headlamp wash is only activated **if the dipped headlamps are on** and the vehicle is **moving**.

With daytime running lamps, to activate the headlamp wash, position the lighting stalk in the dipped beam position.



On vehicles fitted with automatic air conditioning, any action on the windscreen wash control results in temporary closing of the air intake to avoid odours inside the passenger compartment.

## Screenwash/headlamp wash level low

### SERVICE

In the case of vehicles fitted with headlamp washers, when the fluid reservoir low level is reached this warning lamp comes on in the instrument panel, accompanied by an audible signal and a message.

The warning lamp comes on when the ignition is switched on, or every time the stalk is operated, until the reservoir is refilled. Next time you stop, refill the screenwash / headlamp wash reservoir.

## Automatic rain sensitive windscreen wipers

The windscreen wipers operate automatically, without any action on the part of the driver, if rain is detected (sensor behind the rear view mirror), adapting their speed to the intensity of the rainfall.

### Switching on



Briefly push the control stalk downwards. A wiping cycle confirms that the instruction has been accepted. This warning lamp comes on in the instrument panel and a message is displayed.

### Switching off



Briefly push the control stalk downwards again, or place the control stalk in another position (Int, 1 or 2). This warning lamp goes off in the instrument panel and a message is displayed.

**i** The automatic rain sensitive windscreen wipers must be reactivated by pushing the control stalk downwards, if the ignition has been off for more than one minute.

### Operating fault

If a fault occurs with the automatic rain sensitive wipers, the wipers will operate in intermittent mode. Have it checked by PEUGEOT dealer or a qualified workshop.

**!** Do not cover the rain sensor, linked with the sunshine sensor and located in the centre of the windscreen behind the rear view mirror. Switch off the automatic rain sensitive wipers when using an automatic car wash. In winter, it is advisable to wait until the windscreen is completely clear of ice before activating the automatic rain sensitive wipers.

## Special position of the windscreen wipers



This position permits release of the windscreen wiper blades.

It is used for cleaning or replacement of the wiper blades. It can also be useful, in winter, to release the wiper blades from the windscreen.

- ☞ Any action on the wiper stalk within one minute after switching off the ignition places the wiper blades vertically on the screen.
- ☞ To park the wiper blades again, switch on the ignition and operate the wiper stalk.

- i** To maintain the effectiveness of the flat wiper blades, it is advisable to:
- handle them with care,
  - clean them regularly using soapy water,
  - avoid using them to retain cardboard on the windscreen,
  - replace them at the first signs of wear.

## Heated windscreen and washer jets\*

This function heats the windscreen and washer jets under cold conditions.



In area 1, the heating frees the wiper blades when they are stuck by snow or ice.

In area 2, the heating improves visibility by avoiding the accumulation of snow when the wipers are operating.

### Switching on



- ☞ With the engine running, press this button; its indicator lamp comes on.

The period of operation depends on the ambient temperature.

Pressing this button again switches the function off; its indicator lamp goes off.

\* Depending on the country of sale.

## Hazard warning lamps

Visual warning with all of the direction indicators flashing to alert other road users to a vehicle breakdown, towing or accident.

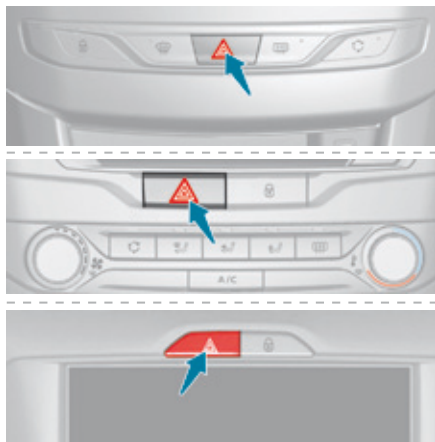

- ☞ Press this button, all of the direction indicators flash. They can operate with the ignition off.

### Automatic operation of hazard warning lamps

When braking in an emergency, depending on the rate of deceleration, as well as when the ABS regulation is invoked or in the event of an impact, the hazard warning lamps come on automatically.

They switch off automatically the first time you accelerate.

- ☞ You can also switch them off by pressing the button.



## Emergency or assistance call



### PEUGEOT Connect SOS



In an emergency, press this button for more than 2 seconds. Flashing of the green LED and a voice message confirm that the call has been made to the "PEUGEOT Connect SOS" call centre\*.

Pressing this button again immediately cancels the request.

The green LED goes off.

The green LED remains on (without flashing) when communication is established.

It goes off at the end of the call.

"PEUGEOT Connect SOS" immediately locates your vehicle, starts communication with you in your language\*\*, and where necessary sends the appropriate public emergency services\*\*. In countries where the service is not available, or when the locating service has been expressly declined, the call is sent directly to the emergency services (112) without the vehicle location.



**!** If an impact is detected by the airbag control unit, and independently of the deployment of any airbags, an emergency call is made automatically.

**i** If you benefit from the PEUGEOT Connect Packs offer with the SOS and assistance pack included, there are additional services available to you in your MyPEUGEOT personal space, via the Internet website for your country.

\* Subject to the general conditions for the service available from dealers and subject to technological and technical limitations.

\*\* Depending on the geographical cover of "PEUGEOT Connect SOS", "PEUGEOT Connect Assistance" and the official national language selected by the owner of the vehicle. The list of countries covered and PEUGEOT CONNECT services is available from dealers or at [www.peugeot.co.uk](http://www.peugeot.co.uk).

## Operation of the system



When the ignition is switched on, the green LED comes on for 3 seconds indicating that the system is operating correctly.

### For all countries except Russia, Belarus and Kazakhstan.



The red indicator lamp flashes then goes off: there is a system fault.

The red indicator lamp is on continuously: replace the back-up battery.

### For Russia, Belarus and Kazakhstan.



The red indicator lamp is on continuously: there is a system fault.

The red indicator lamp flashes: replace the back-up battery.

In either case, the emergency and assistance calls may not function.

Contact a qualified repairer as soon as possible.

**i** A fault with the system does not prevent the vehicle being driven.

## PEUGEOT Connect Assistance



Press this button for more than 2 seconds to request assistance if the vehicle breaks down.

A voice message confirms that the call has been made\*\*.

Pressing this button again immediately cancels the request.

The cancellation is confirmed by a voice message.

## Geo-location



You can deactivate geo-location by simultaneously pressing the "PEUGEOT Connect SOS" and "PEUGEOT Connect Assistance" buttons, followed by a press on "PEUGEOT Connect Assistance" to confirm.

To reactivate geo-location, simultaneously press the "PEUGEOT Connect SOS" and "PEUGEOT Connect Assistance" buttons again, followed by a press on "PEUGEOT Connect Assistance" to confirm.

**i** If you purchased your vehicle outside the PEUGEOT dealer network, we invite you to have a dealer check the configuration of these services and, if desired, modified to suit your wishes. In a multi-lingual country, configuration is possible in the official national language of your choice.

**i** For technical reasons and in particular to improve the quality of "PEUGEOT CONNECT services" services to customers, the manufacturer reserves the right to carry out updates to the vehicle's on-board telematic system.

\*\* Depending on the geographical cover of "PEUGEOT Connect SOS", "PEUGEOT Connect Assistance" and the official national language selected by the owner of the vehicle. The list of countries covered and PEUGEOT CONNECT services is available from dealers or at [www.peugeot.co.uk](http://www.peugeot.co.uk).

## Horn

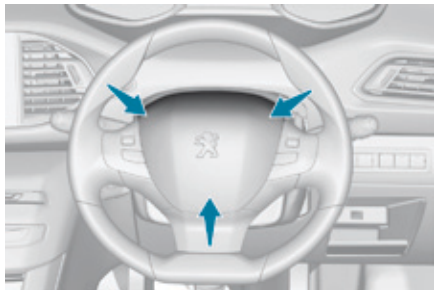

- ☞ Press the central part of the steering wheel.

## Electronic stability control (ESC)

Electronic stability control (ESC) incorporating the following systems:

- anti-lock braking system (ABS) and electronic brake force distribution (EBFD),
- emergency braking assistance (EBA),
- wheel anti-slip regulation (ASR) or traction control,
- dynamic stability control (DSC).

### Definitions

#### Anti-lock braking system (ABS) and electronic brake force distribution (EBFD)

This system improves the stability and manoeuvrability of your vehicle when braking and contributes towards improved control on corners, in particular on poor or slippery road surfaces.

The ABS prevents wheel lock in the event of emergency braking.

The EBFD manages the braking pressure wheel by wheel.

#### Emergency braking assistance (EBA)

In an emergency, this system enables you to reach the optimum braking pressure more quickly and therefore reduce the stopping distance.

It is triggered according to the speed at which the brake pedal is pressed. This is felt by a reduction in the resistance of the pedal and an increase in the effectiveness of the braking.

#### Anti-slip regulation (ASR)

The ASR system (also known as Traction Control) optimises traction in order to limit wheel slip by acting on the brakes of the driving wheels and on the engine. It also improves the directional stability of the vehicle on acceleration.

#### Dynamic stability control (DSC)

If there is a difference between the path followed by the vehicle and that required by the driver, the DSC monitors each wheel and automatically acts on the brake of one or more wheels and on the engine to return the vehicle to the required path, within the limits of the laws of physics.

## Intelligent traction control system

Depending on version, your vehicle has a system to help driving on snow: **intelligent traction control**.

This system detects situations of difficult surface grip that could make it difficult to move off or make progress on deep fresh snow or compacted snow.

In these situations, the **intelligent traction control** limits the amount of wheel spin to provide the best traction and trajectory control for your vehicle.

The use of snow tyres is strongly recommended on surfaces offering low levels of adhesion.

## Anti-lock braking system (ABS) and electronic brake force distribution (EBFD)

The fixed illumination of this warning lamp indicates that there is a fault with the ABS.



The vehicle retains conventional braking. Drive carefully at moderate speed.



When this warning lamp comes on, coupled with the **STOP** and ABS warning lamps, accompanied by an audible signal and a message, it indicates that there is a fault with the electronic brake force distribution (EBFD).

### **You must stop as soon as it is safe to do so.**

In both cases, have the system checked by a PEUGEOT dealer or a qualified workshop as soon as possible.

**i** When changing wheels (tyres and rims), ensure that these are approved for your vehicle. Normal operation of the ABS may make itself felt by slight vibrations of the brake pedal.

**!** **In emergency braking, press very firmly and maintain this pressure.**

## Dynamic stability control (DSC) and anti-slip regulation (ASR)

### Activation



These systems are activated automatically each time the vehicle is started.

As soon as they detect a problem of grip or trajectory, these systems act on the operation of the engine and brakes.



This is indicated by flashing of this warning lamp in the instrument panel.

### Deactivation

In exceptional conditions (starting a vehicle which is bogged down, stuck in snow, on soft ground...), it may be advisable to deactivate the DSC system, so that the wheels can spin freely and regain grip.

It is however recommended that the system be reactivated as soon as possible.



☞ Press the button.



This warning lamp and the indicator lamp in the button come on: the DSC system no longer acts on the operation of the engine.

### Reactivation

The system is reactivated automatically each time the ignition is switched back on or from 30 mph (50 km/h) (except GT and GTi versions).



☞ Press the button again to reactivate it manually.

### Operating fault



If this warning lamp comes on, accompanied by an audible signal and a message, this indicates a fault with the system.

Contact a PEUGEOT dealer or a qualified workshop to have the system checked.

**!** The DSC system offers exceptional safety in normal driving, but this should not encourage the driver to take extra risks or drive at high speed.

The correct operation of the system depends on observation of the manufacturer's recommendations regarding the wheels (tyres and rims), the braking components, the electronic components and the assembly and repair procedures used by PEUGEOT dealers.

To fully benefit from the effectiveness of these systems in wintry conditions, it is essential to fit a set of four winter tyres to the vehicle. This will allow the vehicle to retain a neutral behaviour. After an impact, have the system checked by a PEUGEOT dealer or a qualified workshop.

## Seat belts

### Front seat belts



The front seat belts are fitted with a pretensioning and force limiting system. This system improves safety in the front seats in the event of a front or side impact. Depending on the severity of the impact, the pretensioning system instantly tightens the seat belts against the body of the occupants. The pretensioning seat belts are active when the ignition is on. The force limiter reduces the pressure of the seat belt on the chest of the occupant, so improving their protection.

### Rear seat belts



The rear seats are each fitted with a seat belt, three-point anchorages with inertia reel and force limiter (except for the centre rear seat).

### Fastening



- ☞ Pull the strap, then insert the tongue in the buckle.
- ☞ Check that the seat belt is fastened correctly by pulling the strap.

### Unfastening

- ☞ Press the red button on the buckle.
- ☞ Guide the seat belt as it reels in.

## Seat belt not fastened / unfastened warning lamps



1. Front and/or rear seat belts not fastened / unfastened warning lamp in the instrument panel.
2. Front left seat belt warning lamp.
3. Front right seat belt warning lamp.
4. Rear right seat belt warning lamp.
5. Rear centre seat belt warning lamp.
6. Rear left seat belt warning lamp.



From approximately 12 mph (20 km/h), the warning lamp(s) flash for two minutes accompanied by an audible signal. Once these two minutes have elapsed, the warning lamp(s) remain on until the driver or one or more passengers fasten their seat belt.

## Front and rear seat belt warning lamps



On switching on the ignition, warning lamp 1 comes on in the instrument panel and the corresponding warning lamp (2 to 6) comes on in red in the passenger's seat belt and front airbag warning lamp display if the corresponding seat belt is not fastened or is unfastened.



If a rear seatbelt is not fastened, the corresponding warning lamp (4 to 6) comes on for about 30 seconds.

## **i** Advice

The driver must ensure that passengers use the seat belts correctly and that they are all fastened before setting off.

Wherever you are seated in the vehicle, always fasten your seat belt, even for short journeys.

Do not interchange the seat belt buckles as they will not fulfill their role fully.

The seat belts are fitted with an inertia reel permitting automatic adjustment of the length of the strap to your size. The seat belt is stowed automatically when not in use.

Before and after use, ensure that the seat belt is reeled in correctly.

The lower part of the strap must be positioned as low as possible on the pelvis. The upper part must be positioned in the hollow of the shoulder.

The inertia reels are fitted with an automatic locking device which comes into operation in the event of a collision, emergency braking or if the vehicle rolls over. You can release the device by pulling the strap firmly and then releasing it so that it reels in slightly.

In order to be effective, a seat belt must:

- be tightened as close to the body as possible,
- be pulled in front of you with a smooth movement, checking that it does not twist,
- be used to restrain only one person,
- not bear any trace of cuts or fraying,
- not be converted or modified to avoid affecting its performance.

In accordance with current safety regulations, for all repairs on your vehicle's seat belts, go to a qualified workshop with the skills and equipment needed, which a PEUGEOT dealer is able to provide. Have your seat belts checked regularly by a PEUGEOT dealer or a qualified workshop, particularly if the straps show signs of damage.

Clean the seat belt straps with soapy water or a textile cleaning product, sold by PEUGEOT dealers.

After folding or moving a seat or rear bench seat, ensure that the seat belt is positioned and reeled in correctly.

## **Recommendations for children**

Use a suitable child seat if the passenger is less than 12 years old or shorter than one and a half metres.

Never use the same seat belt to secure more than one person.

Never allow a child to travel on your lap.

For more information on **Child seats**, refer to the corresponding section.

## **In the event of an impact**

**Depending on the nature and seriousness of the impact**, the pretensioning device may be deployed before and independently of the airbags.

Deployment of the pretensioners is accompanied by a slight discharge of harmless smoke and a noise, due to the activation of the pyrotechnic cartridge incorporated in the system.

In all cases, the airbag warning lamp comes on.

Following an impact, have the seat belts system checked, and if necessary replaced, by a PEUGEOT dealer or a qualified workshop.



# Airbags

## General information

System designed to contribute towards improving the safety of the occupants (with the exception of the rear centre passenger) in the event of violent collisions. The airbags supplement the action of the seat belts fitted with force limiters (all except the centre rear passenger belt).

If a collision occurs, the electronic detectors record and analyse the front and side impacts sustained in the impact detection zones:

- in the case of a serious impact, the airbags are deployed instantly and contribute towards better protection of the occupants of the vehicle (with the exception of the rear centre passenger); immediately after the impact, the airbags deflate rapidly so that they do not hinder visibility or the exit of the occupants,
- in the case of a minor or rear impact or in certain roll-over conditions, the airbags may not be deployed; the seat belt alone contributes towards ensuring your protection in these situations.

### **!** The airbags do not operate when the ignition is switched off.

This equipment will only deploy once. If a second impact occurs (during the same or a subsequent accident), the airbag will not be deployed again.

## Impact detection zones



- A. Front impact zone.
- B. Side impact zone.

**i** Deployment of one or more of the airbags is accompanied by a slight emission of smoke and a noise, due to the activation of the pyrotechnic cartridge incorporated in the system. This smoke is not harmful, but sensitive individuals may experience slight irritation. The noise of detonation associated with the deployment of one or more airbags may result in a slight loss of hearing for a short time.

## Front airbags

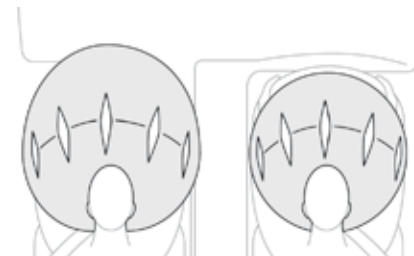

System which protects the driver and front passenger in the event of a serious front impact in order to limit the risk of injury to the head and thorax.

The driver's airbag is fitted in the centre of the steering wheel; the front passenger's airbag is fitted in the dashboard above the glove box.

## Deployment

The airbags are deployed, except the passenger's front airbag if it is deactivated, in the event of a serious front impact to all or part of the front impact zone A, in the longitudinal centreline of the vehicle on a horizontal plane and directed from the front to the rear of the vehicle.

The front airbag inflates between the thorax and head of the front occupant of the vehicle and the steering wheel, driver's side, and the dashboard, passenger's side to cushion their forward movement.

## Deactivating the passenger's front airbag

Only the passenger's front airbag can be deactivated.



- ☞ **With the ignition off**, insert the key in the passenger airbag deactivation switch.
- ☞ Turn it to the **"OFF"** position.
- ☞ Remove the key keeping the switch in the new position.



When the ignition is on, this warning lamp comes in the seat belt warning display screen. It stays on while the airbag is deactivated.



To assure the safety of your child, the passenger's front airbag must be deactivated when you install a rearward facing child seat on the front passenger seat.

Otherwise, the child would risk being seriously injured or killed if the airbag were deployed.

## Reactivating the passenger's front airbag

When you remove the child seat, **with the ignition off**, turn the switch to the **"ON"** position to reactivate the airbag and so assure the safety of your front passenger in the event of an impact.



When the ignition is switched on, this warning lamp comes on in the seat belt warning display screen for approximately one minute to signal that the front airbag is activated.

## Operating fault



If this warning lamp comes on in the instrument panel, you must contact a PEUGEOT dealer or a qualified workshop to have the system checked. The airbags may no longer be deployed in the event of a serious impact.

## Lateral airbags



If fitted to your vehicle, this is a system which protects the driver and front passenger in the event of a serious side impact in order to limit the risk of injury to the chest, between the abdomen and head.

Each lateral airbag is fitted in the seat backrest frame, door side.

### Deployment

The lateral airbags are deployed unilaterally in the event of a serious side impact applied to all or part of the side impact zone, perpendicular to the longitudinal centreline of the vehicle on a horizontal plane and directed from the outside towards the inside of the vehicle.

The lateral airbag inflates between the abdomen and head of the front occupant of the vehicle and the corresponding door trim panel.

## Curtain airbags

System contributing towards greater protection for the driver and passengers (with the exception of the rear centre passenger) in the event of a serious side impact in order to limit the risk of injury to the side of the head. Each curtain airbag is built into the pillars and the upper passenger compartment area.

### Deployment

The curtain airbag is deployed at the same time as the corresponding lateral airbag in the event of a serious side impact applied to all or part of the side impact zone **B**, perpendicular to the longitudinal centreline of the vehicle on a horizontal plane and directed from the outside towards the inside of the vehicle.

The curtain airbag inflates between the front or rear occupant of the vehicle and the windows.

## Operating fault



If this warning lamp comes on in the instrument panel, you must contact a PEUGEOT dealer or a qualified workshop to have the system checked.

The airbags may no longer be deployed in the event of a serious impact.



In the event of a minor impact or bump on the side of the vehicle or if the vehicle rolls over, the airbags may not be deployed.

In the event of a rear or front collision, none of the lateral airbags is deployed.

## ! For the airbags to be fully effective, observe the following safety rules:

Sit in a normal upright position.

Wear a correctly adjusted seat belt.

Do not leave anything between the occupants and the airbags (a child, pet, object...), nor fix or attach anything close to the inflation trajectory of the airbags; this could cause injuries during their deployment.

Never modify the original definition of your vehicle, particularly in the area directly around the airbags.

After an accident or if the vehicle has been stolen or broken into, have the airbag systems checked.

All work on the airbag system must be carried out by a PEUGEOT dealer or a qualified workshop.

Even if all of the precautions mentioned are observed, a risk of injury or of minor burns to the head, chest or arms when an airbag is deployed cannot be ruled out.

The bag inflates almost instantly (within a few milliseconds) then deflates within the same time discharging the hot gas via openings provided for this purpose.

### Front airbags

Do not drive holding the steering wheel by its spokes or resting your hands on the centre part of the wheel.

Passengers must not place their feet on the dashboard.

Do not smoke as deployment of the airbags can cause burns or the risk of injury from a cigarette or pipe.

Never remove or pierce the steering wheel or hit it violently.

Do not fit or attach anything to the steering wheel or dashboard, this could cause injuries with deployment of the airbags.

### Curtain airbags

Do not fix or attach anything to the roof. This could cause injury to the head if the curtain airbag is deployed.

If fitted on your vehicle, do not remove the grab handles installed on the roof, they play a part in securing the curtain airbags.

### Lateral airbags

Use only approved covers on the seats, compatible with the deployment the lateral airbags. For information on the range of seat covers suitable for your vehicle, you can contact a PEUGEOT dealer.

For more information on **Accessories**, refer to the corresponding section.

Do not fix or attach anything to the seat backrests (clothing...). This could cause injury to the chest or arms if the lateral airbag is deployed.

Do not sit with the upper part of the body any nearer to the door than necessary.

The vehicle's front door panels include side impact sensors.

A damaged door or any unauthorised or incorrectly executed work (modification or repair) on the front doors or their interior trim could compromise the operation of these sensors - Risk of malfunction of the lateral airbags!

Such work must only be done by a PEUGEOT dealer or a qualified workshop.

# Carrying children

## General points

Although one of PEUGEOT's main criteria when designing your vehicle, the safety of your children also depends on you.

For maximum safety, please observe the following recommendations:

- in accordance with European regulations, **all children under the age of 12 or less than one and a half metres tall must travel in approved child seats suited to their weight**, on seats fitted with a seat belt or ISOFIX mountings\*,
- **statistically, the safest seats in your vehicle for carrying children are the rear seats,**
- **a child weighing less than 9 kg must travel in the rearward facing position both in the front and in the rear.**

- i** **PEUGEOT recommends** that children should travel on the **rear seats** of your vehicle:
- **rearward facing** up to the age of 3,
  - **forward facing** over the age of 3.

\* The regulations on carrying children are specific to each country. Refer to the legislation in force in your country.

## Child seat at the rear

### Rearward facing

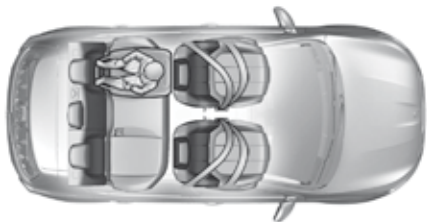

When a rearward facing child seat is installed **on a rear passenger seat**, move the vehicle's front seat forward and straighten the backrest so that the rearward facing child seat does not touch the vehicle's front seat.

### Forward facing

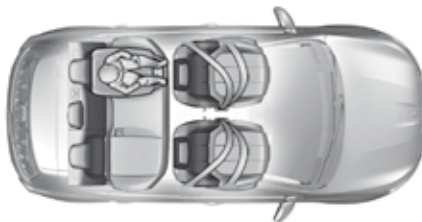

When a forward facing child seat is installed **on a rear passenger seat**, move the vehicle's front seat forward and straighten the backrest so that the legs of the child in the forward facing child seat do not touch the vehicle's front seat.

### Centre rear seat

A child seat with a support leg must never be installed on the **centre rear passenger seat**.

The incorrect installation of a child seat in a vehicle compromises the protection of the child in the event of an accident.

- i** Ensure that the seat belt is correctly tensioned.  
For child seats with a support leg, ensure that this is in firm contact with the floor. If necessary, adjust the front seat of the vehicle.

## Child seat at the front\*

### Rearward facing



When a rearward facing child seat is installed on the **front passenger seat**, adjust the seat to the fully back and highest position, with the backrest straightened. The passenger's front airbag must be deactivated. Otherwise, **the child risks being seriously injured or killed if the airbag is deployed.**

### Forward facing



When a forward facing child seat is installed on the **front passenger seat**, adjust the vehicle's seat to the fully back and highest position with the seat backrest straightened and leave the passenger's front airbag activated.

- i** Ensure that the seat belt is correctly tensioned.  
For child seats with a support leg, ensure that the support leg is in firm and stable contact with the floor. If necessary, adjust the passenger seat.

\* Refer to the legislation in force in your country before carrying your child in this seating position.



**Passenger seat in the fully back and highest position.**

## Deactivating the passenger front airbag

**!** Never install a rearward facing child restraint system on a seat protected by an active front airbag. This could cause the death of the child or serious injury.

The warning label present on both sides of the passenger sun visor repeats this advice. In line with current legislation, the following tables contain this warning in all of the languages required.



Passenger airbag OFF

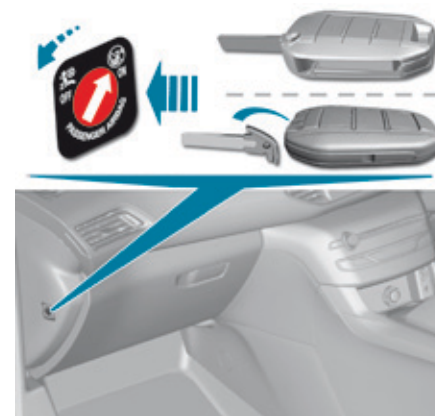

**i** For more information on the **Airbags**, refer to the corresponding section.





|    |   |
|----|---|
| AR | لا يجب أبدا تركيب نظام لإجلاس الطفل الوجه باتجاه الورااء على مقعد سيارة مجهز بوسادة أمان هوائية أمامية مغلقة، فقد يؤدي هذا إلى التسبب بموت الطفل أو بإصابات خطيرة لديه.   |
| BG | НИКОГА НЕ инсталирайте детско столче на седалка с АКТИВИРАНА предна ВЪЗДУШНА ВЪЗГЛАВНИЦА. Това може да причини СМЪРТ или СЕРИОЗНО НАРАНЯВАНЕ на детето.   |
| CS | NIKDY neumistujte dětské zádržné zařízení orientované směrem dozadu na sedadlo chráněné AKTIVOVANÝM čelním AIRBAGEM. Hrozí nebezpečí SMRTI DÍTĚTE nebo VÁŽNĚHO ZRANĚNÍ.   |
| DA | Brug ALDRIG en bagudvendt barnestol på et sæde, der er beskyttet af en AKTIV AIRBAG. BARNET risikerer at blive ALVORLIGT KVÆSTET eller DRÆBT.   |
| DE | Montieren Sie auf einem Sitz mit AKTIVIERTEM Front-Airbag NIEMALS einen Kindersitz oder eine Babyschale entgegen der Fahrtrichtung, das Kind könnte schwere oder sogar tödliche Verletzungen erleiden.  |
| EL | Μη χρησιμοποιείτε ΠΟΤΕ παιδικό κάθισμα με την πλάτη του προς το εμπρός μέρος του αυτοκινήτου, σε μια θέση που προστατεύεται από ΜΕΤΩΠΙΚΟ αερόσακο που είναι ΕΝΕΡΓΟΣ. Αυτό μπορεί να έχει σαν συνέπεια το ΘΑΝΑΤΟ ή το ΣΟΒΑΡΟ ΤΡΑΥΜΑΤΙΣΜΟ του ΠΑΙΔΙΟΥ |
| EN | NEVER use a rearward facing child restraint on a seat protected by an ACTIVE AIRBAG in front of it, DEATH or SERIOUS INJURY to the CHILD can occur  |
| ES | NO INSTALAR NUNCA un sistema de retención para niños de espaldas al sentido de la marcha en un asiento protegido mediante un AIRBAG frontal ACTIVADO, ya que podría causar lesiones GRAVES o incluso la MUERTE del niño.                            |
| ET | Ärge MITTE KUNAGI paigaldage "seljaga sõidusuunas" lapseistet juhi kõrvalistmele, mille ESITURVAPADI on AKTIVEERITUD. Turvapadja avanemine võib last TOSISELT või ELUOHTLIKULT vigastada.   |
| FI | ÄLÄ KOSKAAN aseta lapsen turvaistuinta selkå ajosuuntaan istuimelle, jonka edesså suojana on käyttöön aktivoitu TURVATYNNY. Sen laukeaminen voi aiheuttaa LAPSEN KUOLEMAN tai VAKAVAN LOUKKAANTUMISEN.  |
| FR | NE JAMAIS installer de système de retenue pour enfants faisant face vers l'arrière sur un siège protégé par un COUSSIN GONFLABLE frontal ACTIVÉ.<br>Cela peut provoquer la MORT de l'ENFANT ou le BLESSER GRAVEMENT                                 |
| HR | NIKADA ne postavljati dječju sjedalicu leđima u smjeru vožnje na sjedalo zaštićeno UKLJUČENIM prednjim ZRAČNIM JASTUKOM. To bi moglo uzrokovati SMRT ili TESKU OZLJEDU djeteta.   |
| HU | SOHA ne használjon menetiránynak háttal beszerelt gyermekülést AKTIVÁLT (BEKAPCSOLT) FRONTLÉGSÁKKAL védett ülésen. Ez a gyermek HALÁLÁT vagy SÜLYÖS SÉRÜLÉSÉT okozhatja.  |
| IT | NON installare MAI seggiolini per bambini posizionati in senso contrario a quello di marcia su un sedile protetto da un AIRBAG frontale ATTIVATO. Ciò potrebbe provocare la MORTE o FERITE GRAVI al bambino.  |
| LT | NIEKADA neįrenkite vaiko prilaikymo priemonės su atgal atgretžtu vaiku ant sėdynės, kuri saugoma VEIKIANČIOS priekinės ORO PAGALVĖS. Išsiskleidus oro pagalvei vaikas gali būti MIRTINAI arba SUNKIAI TRAUMUOTAS.                                   |

|    |   |
|----|---|
| LV | NEKAD NEuzstādiēt uz aizmuguri vērstu bērnu sēdekļi priekšējā pasažiera sēdvietā, kurā ir AKTIVIZĒTS priekšējais DROŠĪBAS GAISA SPILVENS.<br>Tas var izraisīt BĒRNA NĀVI vai radīt NOPIETNUS IEVAINOJUMUS.  |
| MT | Qatt m'ghandek thalli tifel/tifla marbut f'siggu dahru lejn l-Airbag attiva, ghalix tista' tikkawza korriment serju jew anke mewt lit-tifel/tifla   |
| NL | Plaats NOOIT een kinderzitje met de rug in de rijrichting op een zitplaats waarvan de AIRBAG is INGESCHAKELD. Bij het afgaan van de airbag kan het KIND LEVENSGEVAARLIJK GEWOND RAKEN   |
| NO | Installer ALDRI et barnesete med ryggen mot kjøreretningen i et sete som er beskyttet med en frontal AKTIVERT KOLLISJONSPUTE, BARNET risikerer å bli DREPT eller HARDT SKADET.  |
| PL | NIGDY nie instalować fotelika dziecięcego w pozycji "tyłem do kierunku jazdy" na siedzeniu wyposażonym w CZŁOWA PODUSZKE POWIETRZNA w stanie AKTYWNYM. Może to doprowadzić do ŚMIERCI DZIECKA lub spowodować u niego POWAŻNE OBRAŻENIA CIAŁA.                                   |
| PT | NUNCA instale um sistema de retenção para crianças de costas para a estrada num banco protegido por um AIRBAG frontal ACTIVADO. Esta instalação poderá provocar FERIMENTOS GRAVES ou a MORTE da CRIANÇA.  |
| RO | Nu instalati NICIODATA un sistem de retenere pentru copii, dispus cu spatele in directia de mers, pe un loc din vehicul protejat cu AIRBAG frontal ACTIVAT. Aceasta ar putea provoca MOARTEA COPILULUI sau RANIREA lui GRAVA.   |
| RU | ВО ВСЕХ СЛУЧАЯХ ЗАПРЕЩАЕТСЯ использовать обращенное назад детское удерживающее устройство на сиденье, защищенном ФУНКЦИОНИРУЮЩЕЙ ПОДУШКОЙ БЕЗОПАСНОСТИ, установленной перед этим сиденьем. Это может привести к ГИБЕЛИ РЕБЕНКА или НАНЕСЕНИЮ ЕМУ СЕРЬЕЗНЫХ ТЕЛЕСНЫХ ПОВРЕЖДЕНИЙ |
| SK | NIKDY neinštalujte detské zádržné zariadenie orientované smerom dozadu na sedadlo chránené AKTIVOVANÝM čelným AIRBAGOM. Mohlo by dôjsť k SMRTELNÉMU alebo VÁŽNEMU PORANENIU DIEŤATA.  |
| SL | NIKOLI ne nameščajte otroškega sedeža s hrbtom v smeri vožnje, če je VARNOSTNA BLAZINA pred sprednjim sopotnikovim sedežem AKTIVIRANA. Takšna namestitev lahko povzroči SMRT OTROKA ali HUDE POŠKODBE.  |
| SR | NIKADA ne koristite dečje sedišta koje se okreće unazad na sedištu zaštićenim AKTIVNIM VAZDUŠNIM JASTUKOM ispred njega, jer mogu nastupiti SMRT ili OZBILJNA POVREDA DETETA.  |
| SV | Passagerarkrockkudden fram MÅSTE vara avaktiverad om en bakåtvänd bilbarnstol installerad på denna plats. Annars riskerar barnet att DÖDAS eller SKADAS ALLVARLIGT.   |
| TR | KESİNLİKLE HAVA YASTIĞI AKTİF olan ön koltuğa yüzü arkaya dönük bir çocuk koltuğu yerleştirmeyiniz. Bu ÇOCUĞUN ÖLMESİNE veya ÇOK AĞIR YARALANMASINA sebep olabilir.   |





# Child seats recommended by PEUGEOT

PEUGEOT offers a range of recommended child seats which are secured using a **three point seat belt**.

| Group 0+: from birth to 13 kg  | Groups 2 and 3: from 15 to 36 kg  |  |
|--|---|--|
|  <p data-bbox="309 503 336 519"><b>L1</b></p> <p data-bbox="204 529 442 545">"RÖMER Baby-Safe Plus"</p> <p data-bbox="142 556 504 572">Installed in the rearward facing position.</p> |  <p data-bbox="767 503 794 519"><b>L4</b></p> <p data-bbox="695 529 866 545">"KLIPPAN Optima"</p> <p data-bbox="619 556 943 599">From 22 kg (approximately 6 years),<br/>the booster is used on its own.</p> |  <p data-bbox="1225 503 1252 519"><b>L5</b></p> <p data-bbox="1158 529 1319 545">"RÖMER KIDFIX"</p> <p data-bbox="1023 556 1458 599">Can be fitted to the vehicle's ISOFIX mountings.<br/>The child is restrained by the seat belt.</p> |

## Locations for child seats secured with the seat belt

In accordance with the European legislation, this table indicates the options for the installation of child seats secured using the seat belt and universally approved (a) in relation to the weight of the child and the seat in the vehicle.

| Weight of the child / indicative age  |   |  |   |  |   |
|---|---|--|---|--|---|
| Seat  |   | Less than 13 kg<br>(groups 0 (b) and 0+)<br>Up to approx. 1 year | From 9 to 18 kg<br>(group 1)<br>From approx. 1 to 3 years | From 15 to 25 kg<br>(group 2)<br>From approx. 3 to 6 years | From 22 to 36 kg<br>(group 3)<br>From approx. 6 to 10 years |
| Front passenger seat (c) (d)<br>- with height adjustment<br>- without height adjustment<br>(straightening the backrest) |  | U (R)  | U (R)   | U (R)  | U (R)   |
|   |   | U (R)  | U (R)   | U (R)  | U (R)   |
| Hatchback   |   |  |   |  |   |
| Outer rear seats (e)  |  | U  | U   | U  | U   |
| Centre rear seat (e)  |  | U (f)  | U (f)   | X  | X   |
| SW  |   |  |   |  |   |
| Outer rear seats (e)  |  | U  | U   | U  | U   |
| Centre rear seat (e)  |  | X  | X   | X  | X   |

- U** Seat suitable for the installation of a child seat secured using the seat belt and universally approved rearward facing and/or forward facing.
- U(R)** As for **U**, the vehicle seat must be adjusted to the highest and fully back position.
- X** Seat not suitable for the installation of a child seat of the weight group indicated.
- (a) Universal child seat: child seat which can be installed in all vehicles using the seat belt.
  - (b) Group 0: from birth to 10 kg. Infant car seats and "car cots" cannot be installed on the front passenger seat.
  - (c) Consult the legislation in force in your country before installing your child on this seat.
  - (d) When a rearward facing child seat is installed on the front passenger seat, the passenger's front airbag must be deactivated. Otherwise the child risks being seriously injured or killed if the airbag is deployed.  
When a forward facing child seat is installed on the front passenger seat, leave the passenger's front airbag active.
  - (e) To install a child seat on a rear seat, rearward or forward facing, move the front seat forward, then straighten the backrest to allow enough room for the child seat and the child's legs.
  - (f) A child seat with support leg must never be installed on the centre rear passenger seat.

**i** Remove and stow the head restraint before fitting a child seat with a backrest to a passenger seat. Refit the head restraint when the child seat is removed.

## "ISOFIX" mountings

Your vehicle has been approved to the **latest ISOFIX regulations**.  
The seats shown below are fitted with regulation ISOFIX mountings.

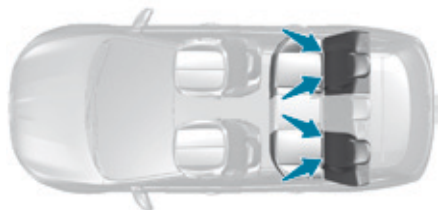

There are three rings for each seat.  
Two rings **A**, located between the seat backrest and cushion, indicated by an ISOFIX marking.

- i** These rings are located behind covers (hatchback) or clear closures (SW).  
For access to them:
  - ☞ Unclip the covers by pulling them forward then pivot them upward (hatchback).
  - ☞ Pull the clear closures up to open them (SW).

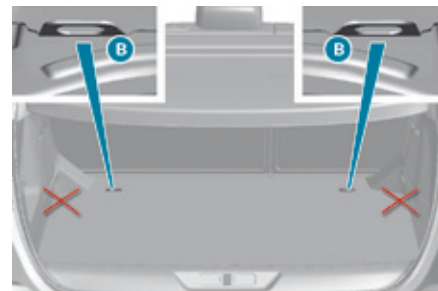

A ring **B** is located in the boot (indicated by a marking), referred to as the **TOP TETHER**, for fixing the upper strap.  
The TOP TETHER is used to secure the upper strap of child seats that have them. This limits the forward tipping of the child seat in the event of a frontal impact.  
The TOP TETHER is located on the boot floor behind the seat backrest.

**!** Do not use the luggage net rings (hatchback) or lashing rings (SW), located at the edges of the boot floor.

This ISOFIX mounting system provides fast, reliable and safe fitting of the child seat in your vehicle.

The **ISOFIX child seats** are fitted with two latches which are easily secured on the two rings **A**.

Some also have an **upper strap** which is attached to ring **B**.

To secure the child seat to the **TOP TETHER**:

- remove and stow the head restraint before installing the child seat on the vehicle seat (refit it when the child seat is removed),
- pass the child seat upper strap over the top of the seat backrest, centring it between the apertures for the head restraint rods,
- attach the upper strap to the ring **B**,
- tighten the upper strap.

**!** The incorrect installation of a child seat in a vehicle compromises the child's protection in the event of an accident. Observe strictly the fitting instructions provided with the child seat.

**i** For information regarding the ISOFIX child seats which can be installed in your vehicle, refer to the table showing the locations for installing ISOFIX child seats.

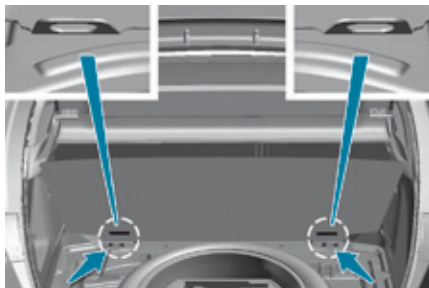

If your vehicle has a spare wheel of the same size as the four wheels, follow the procedure below:

- ☞ pass the strap and buckle over the boot floor (in the slot),
- ☞ raise the boot floor,
- ☞ lift out the upper storage box, located alongside the wheel,
- ☞ attach the spring hook to the **TOP TETHER** ring,
- ☞ refit the storage box and boot floor.

## ISOFIX child seats recommended by PEUGEOT

**i** PEUGEOT offers a range of ISOFIX child seats listed and type approved for your vehicle. Refer also to the child seat manufacturer's fitting instructions for information on installing and removing the seat.

**"RÖMER Baby-Safe Plus" and its ISOFIX base**  
(size category: E)

**Group 0+:** from birth to 13 kg

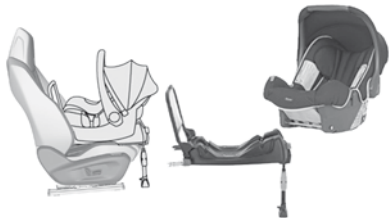

Installed rearward facing using an ISOFIX base which is attached to the rings **A**. The base has a support leg, adjustable for height, which sits on the vehicle's floor. This child seat can also be secured with a seat belt. In this case, only the shell is used and attached to the vehicle's seat by the three-point seat belt.

**"Baby P2C Midi" and its ISOFIX base**  
(size categories: D, C, A, B, B1)

**Group 1:** from 9 to 18 kg



Installed rearward facing using an ISOFIX base which is attached to the rings **A**. The base has a support leg, adjustable for height, which sits on the vehicle's floor. This child seat can also be used forward facing. This seat can **not** be secured with a seat belt. We recommend that you use the seat in the rearward facing position up to the age of 3 years.

**"RÖMER Duo Plus ISOFIX"**  
(size category: B1)

**Group 1:** from 9 to 18 kg







Is installed only in the forward facing position.  
Is attached to the rings **A** and the upper ring **B**, referred to as the TOP TETHER, using an upper strap.  
Three seat body angles: sitting, reclining, lying down.  
This child seat can also be used on seats not equipped with ISOFIX mountings. In this case, it must be secured to the vehicle's seat by the three-point seat belt. Adjust the position of the vehicle's front seat so that the child's feet are not touching the backrest.



## Locations for ISOFIX child seats

In accordance with European legislation, this table indicates the options for installing ISOFIX child seats on seats in the vehicle fitted with ISOFIX mountings.

In the case of universal and semi-universal ISOFIX child seats, the ISOFIX size category, determined by a letter from **A** to **G**, is indicated on the child seat next to the ISOFIX logo.

|  | Weight of the child / indicative age                      |   |   |                     |                     |  |                            |                |   |    |
|--|---|---|---|---------------------|---------------------|--|----------------------------|----------------|---|----|
|  | Less than 10 kg<br>(group 0)<br>Up to approx.<br>6 months |   | Less than 10 kg<br>(group 0)<br>Less than 13 kg<br>(group 0+)<br>Up to approx. 1 year |                     |                     | From 9 to 18 kg (group 1)<br>From approx. 1 to 3 years |                            |                |   |    |
| Type of ISOFIX child seat  | Cot   |   | rearward facing   |                     |                     | rearward facing  |                            | forward facing |   |    |
| ISOFIX size category   | F   | G | C   | D                   | E                   | C  | D                          | A              | B | B1 |
| Front passenger seat  | Not ISOFIX  |   |   |                     |                     |  |                            |                |   |    |
| <b>Hatchback</b>   |   |   |   |                     |                     |  |                            |                |   |    |
| Outer rear seats      | <b>IL-SU</b><br>(a+b)                                     |   | <b>IL-SU</b><br>(c)   | <b>IL-SU</b><br>(a) | <b>IL-SU</b><br>(c) | <b>IL-SU</b><br>(a)                                    | <b>IUF</b><br><b>IL-SU</b> |                |   |    |
| Centre rear seat      | Not ISOFIX  |   |   |                     |                     |  |                            |                |   |    |
| <b>SW</b>  |   |   |   |                     |                     |  |                            |                |   |    |
| Outer rear seats      | <b>IL-SU</b><br>(a+b)                                     |   | <b>IL-SU</b><br>(c)   | <b>IL-SU</b><br>(a) | <b>IL-SU</b><br>(c) | <b>IL-SU</b><br>(a)                                    | <b>IUF</b><br><b>IL-SU</b> |                |   |    |
| Centre rear seat      | Not ISOFIX  |   |   |                     |                     |  |                            |                |   |    |

- IUF** Seat suitable for the installation of an Isofix **Universal** seat, **Forward facing** secured using the upper strap.
- IL-SU** Seat suitable for the installation of an Isofix **Semi-Universal** seat either:
- rearward facing fitted with an upper strap or a support leg,
  - forward facing fitted with a support leg,
  - an infant car seat fitted with an upper strap or a support leg.
- X** Seat not suitable for the installation of a child seat of the weight group indicated.
- (a) Move a seat without height adjustment forwards by 1 notch from the mid position forwards and backwards. A seat with height adjustment must be in the highest position.
- (b) The installation of an infant carrier on one of the outer seats makes use of the other two seats impossible.
- (c) A seat with height adjustment must be placed in the highest position. Move the seat without height adjustment forward by 5 notches from the mid-position forwards and backwards.

**i** For more information on **ISOFIX mountings and child seats** and in particular the upper strap, refer to the corresponding section.

**!** Remove and stow the head restraint before fitting a child seat with a backrest to a passenger seat. Refit the head restraint when the child seat is removed.

## Child lock

This mechanical system prevents opening of a rear door using its interior control. The control is located on the edge of each rear door and locking is independent for each door.



### Locking

- ☞ Using the integral ignition key, turn the control as far as it will go:
- to the left on the left-hand rear door,
  - to the right on the right-hand rear door.

### Unlocking

- ☞ Using the integral ignition key, turn the control as far as it will go:
- to the right on the left-hand rear door,
  - to the left on the right-hand rear door.

## Recommendations

### ! Child seats

The incorrect installation of a child seat in a vehicle compromises the child's protection in the event of an accident.

Check that there is no seat belt or seat belt buckle under the child seat as this could destabilise it.

Remember to fasten the seat belts or the child seat harnesses **keeping the slack** in relation to the child's body **to a minimum**, even for short journeys.

For the installation of a child seat using a seat belt, ensure that this is well tensioned on the child seat and that it is holding the child seat firmly against the seat of your vehicle. If your front passenger seat is adjustable, move it forward if necessary.

At the rear seats, always leave sufficient space between the front seat and:

- a rearward facing child seat,
- the feet of a child seated in a forward facing child seat.

For this, move the front seat forward and if necessary straighten its backrest.

For optimum installation of the forward facing child seat, ensure that the back of the child seat is as close as possible to the backrest of the vehicle's seat, or in contact if possible. The head restraint must be removed before installing a child seat with a backrest on the passenger seat.

Ensure that the head restraint is stowed or attached securely so that it is not thrown around the vehicle in the event of sharp braking.

Refit the head restraint as soon as the child seat is removed.

### Children at the front

The legislation on carrying a child on the front passenger seat is specific to each country. Refer to the legislation in force in the country in which you are driving.

Deactivate the passenger front airbag when a rearward facing child seat is installed on the front passenger seat. Otherwise, the child would risk being seriously injured or killed if the airbag were deployed.

### Installing a booster cushion

The chest part of the seat belt must be positioned on the child's shoulder without touching the neck.

Ensure that the lap part of the seat belt passes correctly over the child's thighs. PEUGEOT recommends the use of a booster seat which has a back, fitted with a seat belt guide at shoulder level.

As a safety precaution, do not leave:

- one or more children alone and unsupervised in a vehicle,
- a child or an animal in a vehicle which is exposed to the sun, with the windows closed,
- the keys within reach of children inside the vehicle.

To prevent accidental opening of the doors, use the child lock.

Take care not to open the rear windows by more than one third.

To protect young children from the rays of the sun, fit side blinds on the rear windows.

## Driving recommendations

Observe the driving regulations and remain vigilant whatever the traffic conditions.

Pay close attention to the traffic and keep your hands on the wheel so that you are ready to react at any time to any eventuality.

On a long journey, a break every two hours is strongly recommended.

In difficult weather, drive smoothly, anticipate the need to brake and increase the distance from other vehicles.

### Driving on flooded roads

We strongly advise against driving on flooded roads, as this could cause serious damage to the engine or gearbox, as well as to the electrical systems of your vehicle.

If you are obliged to drive through water:



- check that the depth of water does not exceed 15 cm, taking account of waves that might be generated by other users,
- deactivate the Stop & Start system,
- drive as slowly as possible without stalling. In all cases, do not exceed 6 mph (10 km/h),
- do not stop and do not switch off the engine.

On leaving the flooded road, as soon as circumstances allow, make several light brake applications to dry the brake discs and pads. If in doubt on the state of your vehicle, contact a PEUGEOT dealer or a qualified workshop.

### Important!

**!** Never drive with the parking brake applied - Risk of overheating and damage to the braking system!  
Risk of fire!

As the exhaust system of your vehicle is very hot, even several minutes after switching off the engine, do not park or run the engine over areas where inflammable substances and materials are present: grass, leaves, etc.

**!** Never leave a vehicle unsupervised with the engine running. If you have to leave your vehicle with the engine running, apply the parking brake and put the gearbox into neutral or position **N** or **P**, depending on the type of gearbox.

## When towing

### Distribution of loads

☞ Distribute the load in the trailer so that the heaviest items are as close as possible to the axle and the nose weight approaches the maximum permitted without exceeding it. Air density decreases with altitude, thus reducing engine performance. Above 1 000 metres, the maximum towed load must be reduced by 10 % for every 1 000 metres of altitude.

**i** For more information on **Weights**, refer to the corresponding section.

### Side wind

☞ Take into account the increased sensitivity to side wind.

### Cooling

Towing a trailer on a slope increases the temperature of the coolant. As the fan is electrically controlled, its cooling capacity is not dependent on the engine speed.

☞ To lower the engine speed, reduce your speed.

The maximum towed load on a long incline depends on the gradient and the ambient temperature. In all cases, keep a check on the coolant temperature.



☞ If the warning lamp and the **STOP** warning lamp come on, stop the vehicle and switch off the engine as soon as possible.

### Braking

Towing a trailer increases the braking distance. To avoid overheating of the brakes, the use of engine braking is recommended.

### Tyres

☞ Check the tyre pressures of the towing vehicle and of the trailer, observing the recommended pressures.

### Lighting

☞ Check the electrical lighting and signalling on the trailer and the headlamp beam height of your vehicle.

**i** For more information on **Adjusting the headlamp beam height**, refer to the corresponding section.

**i** The rear parking sensors will be deactivated automatically to avoid the audible signal if a genuine PEUGEOT towbar is used.

# Starting-switching off the engine, remote control

Put the gear lever into neutral.

## Ignition switch

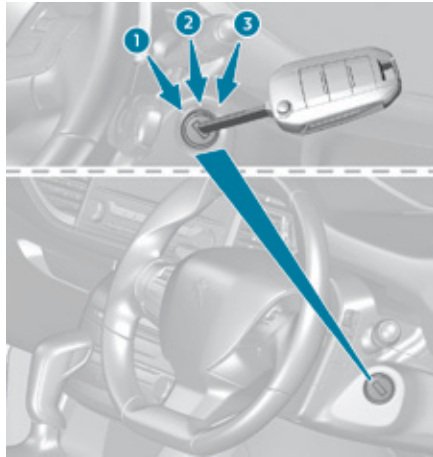

1. **Stop** position.
2. **Ignition on** position.
3. **Starting** position.

## Starting using the key

The parking brake must be applied.



- ☞ With a manual gearbox, place the gear lever in neutral then fully depress the clutch pedal.

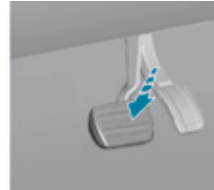
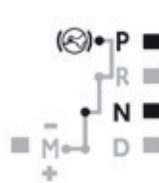

- ☞ With an automatic gearbox, place the gear lever at position **N** or **P** then press the brake pedal firmly.



- ☞ Insert the key in the ignition switch. The system recognises the starting code.
- ☞ Unlock the steering column by simultaneously turning the steering wheel and the key.

**i** In certain circumstances, you may have to apply some force to turn the wheels (if the wheels are against a kerb, for example).

☞ With a petrol engine, operate the starter motor by turning the key to position **3** until the engine starts, without pressing the accelerator. Once the engine starts, release the key.

☞ With a Diesel engine, turn the key to position **2**, ignition on, to operate the engine pre-heating system.



☞ Wait until this warning lamp goes off in the instrument panel, then operate the starter motor by turning the key to position **3** until the engine starts, without pressing the accelerator. Once the engine starts, release the key.

**i** In wintry conditions, the period of illumination of this warning lamp is extended. When the engine is hot, the warning lamp does not come on.

**!** If the engine does not start straight away, switch off the ignition. Wait a few moments before trying again. If the engine does not start after a few attempts, do not keep trying: you risk damaging the starter motor and the engine. Call on a PEUGEOT dealer or a qualified workshop.

**i** In temperate conditions, do not leave the engine running to warm up, but set off straight away and drive at moderate speed.

**!** Never leave the engine running in an enclosed area without adequate ventilation: internal combustion engines emit toxic exhaust gases, such as carbon monoxide. Danger of intoxication and death. In very severe wintry conditions (temperatures below  $-23^{\circ}\text{C}$ ), to ensure the correct operation and the durability of the mechanical components of your vehicle, engine and gearbox, it is necessary to leave the engine running for 4 minutes before moving off.

## Switching off using the key

- ☞ Immobilise the vehicle.
- ☞ Turn the key fully towards you to position **1 (Stop)**.
- ☞ Remove the key from the ignition switch.
- ☞ To lock the steering column, turn the steering wheel until it locks.

**i** To facilitate unlocking of the steering wheel, it is recommended that you place the wheels in the straight ahead position before switching off the engine.



- ☞ Check that the parking brake is correctly applied, particularly when parking on a slope.



- With a manual parking brake, the lever must be pulled up.
- With an electric parking brake, the indicator lamp in the control lever must be on.

**!** Never switch off the ignition until the vehicle has been brought to a complete stop.

**i** When leaving the vehicle, remove the key and lock the doors.

**!** Switching off the engine leads to a loss of braking assistance.

**i** Avoid attaching heavy objects to the key or the remote control, which would weigh down on its blade in the ignition switch and could cause a malfunction. It could adversely affect the deployment of the front airbag.

### **i** Key left in the "Ignition on" position

If the key has been left in the ignition switch at position **2 (Ignition on)**, the ignition will be switched off automatically after one hour. To switch the ignition back on, turn the key to position **1 (Stop)**, then back to position **2 (Ignition on)**.



# Starting and switching off the engine, "Keyless Entry and Starting"

## Starting



- ☞ Place the electronic key inside the vehicle, in the recognition zone.
- ☞ If your vehicle has a manual gearbox, place the gear lever in neutral then fully depress the clutch pedal.
- ☞ If your vehicle has an automatic gearbox, place the selector at position **P** then press the brake pedal firmly.



- ☞ Press the "**START/STOP**" button.

The steering column unlocks and the engine starts more or less immediately.

(Read the information on Diesel versions).



For **Diesel vehicles**, in sub-zero temperatures the engine will not start until the pre-heater warning lamp has gone off. If this warning lamp comes on after pressing the "START/STOP" button, press down on the brake or clutch pedal until the warning lamp goes off, without pressing the "START/STOP" button again, until the engine starts and runs.



The presence in the recognition zone of the electronic key of the "Keyless Entry and Starting" system is essential. For reasons of safety, do not leave this zone while the engine is running. A message is displayed if the electronic key is not detected in the zone. Move the electronic key into the zone to be able to start the engine.



If one of the starting conditions is not met, a reminder message appears in the instrument panel screen. In some circumstances, it is necessary to turn the steering wheel slightly while pressing the "START/STOP" button to assist unlocking of the steering; a message warns you when this is needed.

## Switching off

☞ Immobilise the vehicle.



☞ With the electronic key inside the vehicle, press the "**START/STOP**" button.

The engine stops and the steering column is locked.

**i** If the vehicle is not immobilised, the engine will not stop.

## Ignition on (without starting)



With the Keyless Entry and Starting remote control inside the vehicle, pressing the "START/STOP" button, **with no action on the pedals**, allows the ignition to be switched on. This also allows the accessories to be used (for example: audio system, lighting...).



☞ Press the "START/STOP" button, the instrument panel comes on but the engine does not start.

☞ Press the button again to switch off the ignition and allow the vehicle to be locked.

**i** With the ignition on, the system automatically goes into energy economy mode to maintain an adequate state of charge in the battery.

## Key not detected Back-up starting



When the electronic key is in the recognition zone and your vehicle does not start after pressing the "START/STOP" button:

☞ Insert the electronic key in the reader.

- ☞ If your vehicle has a manual gearbox, place the gear lever in neutral then fully depress the clutch pedal.
- ☞ If your vehicle has an automatic gearbox, place the selector at position **P** then press the brake pedal firmly.

**START STOP** ☞ Press the "START/STOP" button. The engine starts.

## Back-up switch off



When the electronic key is not detected or is no longer in the recognition zone, a message appears in the instrument panel when you close a door or when you request switching off the engine.



- ☞ To confirm the request to switch off the engine, press and hold the "START/STOP" button for about five seconds.

In the event of a fault with the electronic key, contact a PEUGEOT dealer or a qualified workshop.

## Emergency switch-off



In the event of an emergency only, the engine can be switched off without conditions (even when driving).

Press and hold the "START/STOP" button for about five seconds.

In this case the steering column locks as soon as the vehicle stops.

6

### **i** Key left in reader

You are warned by a message if the electronic key is still in the reader on opening the driver's door.

## Anti-theft protection

### Electronic engine immobiliser

The keys contain an electronic chip which has a secret code. When the ignition is switched on, this code must be recognised in order for starting to be possible.

This electronic engine immobiliser locks the engine management system a few minutes after the ignition is switched off and prevents starting of the engine by anyone who does not have the key.

In the event of a malfunction, you are informed by a message in the instrument panel screen. In this case, your vehicle does not start; contact a PEUGEOT dealer if required.

**!** For reasons of safety and theft protection, do not leave your electronic key in the vehicle, even when you are close to it. It is recommended that you keep it on your person.

## Manual parking brake

### Application

- ☞ With your foot on the brake pedal, pull the parking brake lever up to immobilise your vehicle.



### Release

- ☞ With your foot on the brake pedal, pull the parking brake lever up gently, press the release button then lower the lever fully.



When the vehicle is being driven, this warning lamp coming on, accompanied by an audible signal and a message, indicates that the parking brake is still on or has not been fully released.

**!** When parking on a slope, direct your wheels against the kerb, apply the parking brake, engage a gear and switch off the ignition.

**i** Pressing the brake pedal facilitates the application and release of the manual parking brake.

# Electric parking brake



The system allows the application of the parking brake on switching off the engine and release as the vehicle moves off.

## Indicator lamp



This indicator lamp comes on in the instrument panel and in the control lever to confirm the application of the parking brake.



It goes off to confirm the release of the parking brake.

The driver can take over at any time to apply or release the parking brake, by operating the control lever.



- By briefly **pulling** the control lever to apply the brake,



- By briefly **pushing** the control lever, while pressing the brake pedal, to release it.



The indicator lamp in the control lever flashes during manual application or release.



The technology adopted for the electric parking brake does not allow the fitment of 15 inch wheels.



In the event of a battery failure, the electric parking brake no longer works. As a safety measure, if the parking brake is not applied, immobilise the vehicle by placing a chock against one of the wheels.

With a manual gearbox, you can immobilise the vehicle by engaging a gear.

Contact a PEUGEOT dealer or a qualified workshop.



Never leave a child alone inside the vehicle with the ignition on, as they could release the parking brake.



When towing, parking on a steep slope, or if your vehicle is heavily laden, turn the wheels towards the kerb and engage a gear.

For towing, your vehicle is approved for parking on slopes of up to 12%.

## Automatic release

Ensure first that the engine is running and the driver's door is properly closed.

The electric parking brake **releases automatically and progressively as the vehicle moves off.**

**With a manual gearbox:** fully depress the clutch pedal, engage first gear or reverse; press the accelerator pedal and release the clutch pedal.

**With an automatic gearbox:** select position **D**, **M** or **R** then press the accelerator pedal.



The complete release of the parking brake is confirmed by the brake indicator lamp and the **P** indicator lamp in the control lever going off, accompanied by the display of a message.



When stationary with the engine running, do not depress the accelerator pedal unnecessarily, you risk releasing the parking brake.

## Automatic application

With the vehicle stationary, the parking brake is **automatically applied when the ignition is switched off.**



Application of the parking brake is confirmed by illumination of the brake indicator lamp and the **P** indicator lamp in the control lever, accompanied by the display of a message.



With the engine stalled or in STOP mode of Stop & Start, automatic application does not take place.



With automatic operation, you can manually apply or release the parking brake using the control lever.

## Manual release

With the ignition on or the engine running, to release the parking brake:

- ☞ press the brake pedal,
- ☞ briefly push the control lever.

The complete release of the parking brake is confirmed by the brake indicator lamp and the **P** indicator lamp in the control lever going off, accompanied by the display of a message and an audible signal until the doors are closed.

- i** If you push the control lever without pressing the brake pedal, the parking brake will not be released and a message is displayed.

## Manual application

With the vehicle stationary: briefly pull the control lever.

Confirmation of the instruction is signaled by flashing of the indicator lamp in the control lever.



Application of the parking brake is confirmed by illumination of the brake indicator lamp and the **P** indicator lamp in the control lever, accompanied by the display of a message.



The area in front of the electric parking brake control is not intended for the storage of objects.

## Recommendations

### Label on door panel



- i** Before leaving the vehicle, check that the parking brake is applied: the indicator lamps in the instrument panel and the control lever must be on fixed, not flashing.  
If the parking brake is not applied, there is an audible signal and a message is displayed on opening the driver's door.



## Immobilising the vehicle with the engine running

To immobilise the vehicle with the engine running, briefly pull the control lever.



Application of the parking brake is confirmed by illumination of the brake indicator lamp and the **P** indicator lamp in the control lever, accompanied by the display of a message.



## Parking the vehicle with the parking brake released

**!** In very cold conditions (risk of freezing), during recovery or in a carwash tunnel, it is recommended that the parking brake not be applied.

To immobilise your vehicle, engage a gear or fit a chock to one of the wheels.

- ☞ Switch off the engine.

Application of the parking brake is confirmed by illumination of the indicator lamps in the instrument panel and the control lever.

- ☞ Switch the ignition on again, without starting the engine.
- ☞ Release the parking brake manually by pushing the control lever while keeping your foot on the brake pedal.



The complete release of the parking brake is confirmed by the brake indicator lamp and the **P** indicator lamp in the control lever going off, accompanied by the display of a message.



- ☞ Switch off the ignition.



## Deactivating automatic operation

In some situations, such as very cold weather or towing (caravan, recovery), it may be necessary to deactivate automatic operation of the system.

- ☞ Start the engine.
- ☞ Apply the parking brake with the control lever, if it is released.
- ☞ Take your foot off the brake pedal.
- ☞ Push and hold the control lever in the release direction for at least 10 seconds and no more than 15 seconds.
- ☞ Release the control lever.
- ☞ Press and hold the brake pedal.
- ☞ Pull the control lever in the apply direction for 2 seconds.

 Deactivation of the automatic functions is confirmed by illumination of this indicator lamp in the instrument panel.

- ☞ Release the control lever and the brake pedal.

From this point, the parking brake can only be applied and released manually using the control lever.

Repeat this procedure to reactivate automatic operation.

Reactivation of automatic operation is confirmed by the indicator lamp in the instrument panel going off.

## Emergency braking

 The emergency braking should only be used in an exceptional situation.

In the event of a failure of the brake pedal or in an exceptional situation (e.g. driver taken ill, under instruction), a continuous pull on the control lever will brake the vehicle. Braking takes place while the control lever is being pulled. It is interrupted if the control lever is released.

The ABS and DSC systems provide stability of the vehicle during emergency braking.

If the emergency braking malfunctions, the message "Parking brake control faulty" will be displayed.











If the ABS and DSC systems malfunction, signalled by the illumination of one or both warning lamps in the instrument panel, then stability of the vehicle is no longer guaranteed. In this event, stability must be assured by the driver by repeating alternate "pull-release" actions on the control lever until the vehicle is immobilised.

## Operating faults

The various alert situations are described in this table.

In the event of a fault with the electric parking brake it is recommended that you contact a PEUGEOT dealer or a qualified workshop without delay.

| Situation  | Consequences  |
|--|---|
| Display of the message <b>"Parking brake fault"</b> and this warning lamp.<br><br><b>SERVICE</b>   | <ul style="list-style-type: none"> <li>- Automatic release is not available.</li> <li>- If you attempt an automatic release, a help message is displayed on acceleration when the parking brake is applied, prompting you to use manual release.</li> </ul>   |
| Display of the message <b>"Parking brake fault"</b> and these warning lamps.<br><br><b>SERVICE</b>  | <ul style="list-style-type: none"> <li>- Back-up braking does not have full power.</li> <li>- If automatic release is not available, a help message is displayed on acceleration when the parking brake is applied, prompting you to use manual release.</li> </ul>   |
| Display of the message <b>"Parking brake fault"</b> and these warning lamps.<br><br><b>SERVICE</b>  | <ul style="list-style-type: none"> <li>- Automatic application is not available: use the control lever.</li> <li>- The electric parking brake can only be used manually.</li> <li>- If automatic release is also not available, a help message is displayed on acceleration when the parking brake is applied, prompting you to use manual release.</li> </ul>      |
| Display of the message <b>"Parking brake fault"</b> and these warning lamps.<br><br><b>SERVICE</b>  | <ul style="list-style-type: none"> <li>- If manual application and release do not work, the control lever is faulty.</li> <li>- The automatic functions must be used in all circumstances: they are automatically reactivated in the event of failure of the control lever.</li> <li>- You can no longer immobilise the vehicle with the engine running.</li> </ul> |

| Situation   | Consequences   |
|---|--|
| <p>Display of the message "<b>Parking brake fault</b>" and these warning lamps.</p> <p><b>SERVICE</b>  </p>   | <p>The parking brake is faulty, the manual and automatic functions may not operate.</p> <p><b>When stationary</b>, to immobilise your vehicle:</p> <ul style="list-style-type: none"> <li>☞ pull and hold the control lever for about 7 to 15 seconds, until the warning lamp comes on in the instrument panel.</li> </ul> <p>If this procedure does not work, you should make your vehicle safe:</p> <ul style="list-style-type: none"> <li>☞ park on a level surface,</li> <li>☞ engage a gear,</li> <li>☞ if possible, fit a wheel chock.</li> </ul> <p>Call on a PEUGEOT dealer or a qualified workshop.</p>   |
| <p>Display of the message "<b>Parking brake fault</b>" and these warning lamps.</p> <p><b>SERVICE</b>   </p> | <ul style="list-style-type: none"> <li>- The parking brake does not have its full performance to securely hold the vehicle in all situations.</li> </ul> <p>You should make your vehicle safe:</p> <ul style="list-style-type: none"> <li>- park on a level surface,</li> <li>- engage a gear,</li> <li>- if possible, fit a wheel chock.</li> </ul> <p>Call on a PEUGEOT dealer or a qualified workshop.</p> <p>The flashing of the <b>P</b> warning lamps on starting the vehicle indicates that the parking brake is not correctly applied.</p> <p>As soon as possible, stop the vehicle and try to completely release the parking brake, using the control lever, with your foot on the brake pedal.</p> |
| <p>Display of the message "<b>Battery fault</b>" and this warning lamp.</p> <p></p>  | <ul style="list-style-type: none"> <li>- The state of charge of the battery is very low and requires immobilisation of the vehicle in a safe place.</li> <li>- Once the battery is completely discharged, the controls do not operate: to release the parking brake, call on a PEUGEOT dealer or a qualified workshop.</li> </ul>  |

## Hill start assist

System which keeps your vehicle immobilised temporarily (approximately 2 seconds) when starting on a gradient, the time it takes to move your foot from the brake pedal to the accelerator pedal.

It only operates when:

- the vehicle is completely stationary, with your foot on the brake pedal,
- particular conditions on a slope are met,
- the driver's door is closed.

This hill start assist system cannot be deactivated.

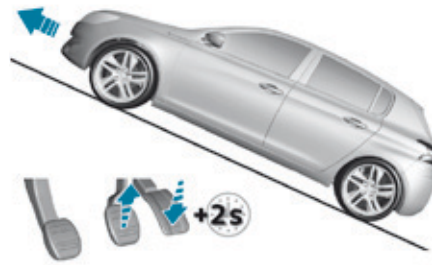

**On an ascending slope, with the vehicle stationary, the vehicle is held momentarily when you release the brake pedal.**

With a manual gearbox, if you are in first gear or neutral.

With an automatic gearbox, if you are in position **D** or **M**.



**On a descending slope, with the vehicle stationary and reverse gear engaged, the vehicle is held momentarily when you release the brake pedal.**

## Operating fault



If a fault in the system occurs, this warning lamp comes on accompanied by a message. Contact a PEUGEOT dealer or a qualified workshop to have the system checked.

## 5-speed manual gearbox

### Engaging reverse gear



- ☞ With the clutch pedal fully down, place the gear lever in neutral.
- ☞ Push the gear lever to the right then backwards.

**!** Only engage reverse gear when the vehicle is stationary with the engine at idle.

**i** As a safety precaution and to facilitate starting of the engine:

- always select neutral,
- press the clutch pedal.

## 6-speed manual gearbox

### Engaging 5<sup>th</sup> or 6<sup>th</sup> gear



- ☞ Move the lever fully to the right to engage 5<sup>th</sup> or 6<sup>th</sup> gear.

**!** Failure to follow this advice may cause permanent damage to the gearbox (engagement of 3<sup>rd</sup> or 4<sup>th</sup> gear by mistake).

### Engaging reverse gear

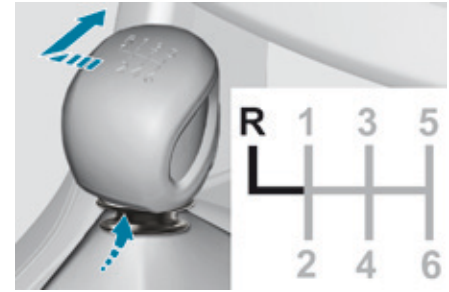

- ☞ Raise the ring under the knob and move the gear lever to the left then forwards.

**!** Only engage reverse gear when the vehicle is stationary with the engine at idle.

**i** As a safety precaution and to facilitate starting of the engine:

- always select neutral,
- press the clutch pedal.

# Gear efficiency indicator

System which reduces fuel consumption by recommending the most suitable gear.

Depending on the driving situation and your vehicle's equipment, the system may advise you to skip one or more gears.

You can follow this instruction without going through the intermediate gears.

**The gear engagement recommendations must not be considered compulsory. This is because the configuration of the road, traffic density and safety remain important factors in the choice of the best gear.**

The gear shift indicator system does not replace the need for vigilance on the part of the driver.

**i** This function cannot be deactivated.

Example:



- You are in third gear.



- You press the accelerator pedal.



- The system may suggest that you engage a higher gear.

The information appears in the instrument panel in the form of an arrow. On vehicles with manual gearbox, the arrow may be accompanied by the recommended gear.

- i** The system adapts its gear change recommendation according to the driving conditions (gradient, load, ...) and the demands of the driver (power, acceleration, braking, ...).  
The system never suggests:
- engaging first gear,
  - engaging reverse gear.
  - changing down.

## Automatic gearbox

Six speed automatic gearbox which offers a choice between the comfort of fully automatic operation, enhanced by sport and snow programmes, or manual gear changing.

Two driving modes are offered:

- **automatic** operation for electronic management of the gears by the gearbox,
  - with the **sport** programme for a more dynamic style of driving
  - or the **snow** programme to improve driving when traction is poor
- **manual** operation for sequential changing of the gears by the driver.

### Gear selection gate

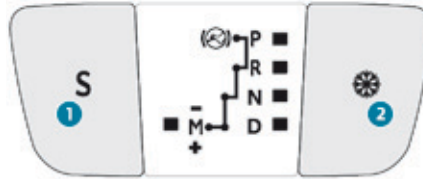

- P.** Park.
- Immobilisation of the vehicle, parking brake on or off.
  - Starting the engine.
- R.** Reverse.
- Reversing manoeuvres, vehicle stationary, engine at idle.
- N.** Neutral.
- Immobilisation of the vehicle, parking brake on.
  - Starting the engine.
- D.** Automatic operation.
- M.+ / -** Manual operation
- Sequential changing of the six gears.
- ☞ Pull towards the + sign and release to change up through the gears.
- or
- ☞ Push towards the - sign and release to change down through the gears.
1. "**S**" (**sport**) programme switch.
  2. "❄" (**snow**) programme switch.

### Steering mounted controls\*



Pull on the **right-hand** steering mounted control paddle to change up.

Pull on the **left-hand** steering mounted control paddle to change down.

**i** The steering mounted control paddles cannot be used to select neutral or to select or come out of reverse.

\* Depending on version.

## Displays in the instrument panel

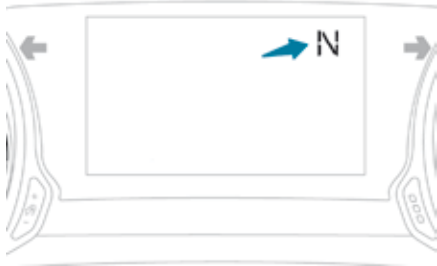

When you move the gear selector in the gate to select a position, the corresponding symbol appears in the instrument panel.

- P.** Park
- R.** Reverse
- N.** Neutral
- D.** Drive (automatic operation)
- S.** Sport programme
- ⊛ **Snow** programme
- 1 to 6.** Gear engaged during manual operation
- . Invalid value during manual operation

## Moving off



- ☞ With your foot on the brake, select position **P** or **N**.

- ☞ Start the engine.

If the conditions are not met, there is an audible signal, accompanied by a message in the instrument panel screen.

- ☞ With the engine running, press the brake pedal.
- ☞ Release the parking brake, unless it is programmed to automatic mode.
- ☞ Select position **R**, **D** or **M**.
- ☞ Gradually release the brake pedal.

The vehicle moves off.

- i** If position **N** is engaged inadvertently while driving, allow the engine to return to idle then engage position **D** to accelerate.

- !** When the engine is running at idle, with the brakes released, if position **R**, **D** or **M** is selected, the vehicle moves even without the accelerator being pressed. When the engine is running, never leave children in the vehicle without supervision. When carrying out maintenance with the engine running, apply the parking brake and select position **P**.



## Automatic operation

- ☞ Select position **D** for **automatic** changing of the six gears.

The gearbox then operates in auto-adaptive mode, without any intervention on the part of the driver. It continuously selects the most suitable gear according to the style of driving, the profile of the road and the load in the vehicle.

For maximum acceleration, without touching the gear selector press the accelerator pedal down fully (kick-down). The gearbox changes down automatically or maintains the gear selected until the maximum engine speed is reached.

On braking, the gearbox changes down automatically to provide efficient engine braking.

If you release the accelerator sharply, the gearbox will not change to a higher gear for safety reasons.

- ! Never select position **N** while the vehicle is moving.  
Never select positions **P** or **R** unless the vehicle is completely stationary.

## Sport and snow programmes

These two special programmes supplement the automatic operation in very specific conditions of use.

### Sport "S"

- ☞ Press the "**S**" switch, after starting the engine. The gearbox automatically favours a dynamic style of driving.



**S** appears in the instrument panel.

If your vehicle has the **Dynamic pack**, refer to the corresponding section which supplements sport mode.

### Snow "❄"

- ☞ Press the "❄" switch, after starting the engine. The gearbox adapts to driving on slippery roads.

This programme improves starting and drive when traction is poor.



❄ appears in the instrument panel.

## Return to automatic operation

- ☞ At any time, press the button selected (**S** or "❄") again at any time to quit the programme engaged and return to auto-adaptive mode.

## Creep function (moving without using the accelerator)

This function provides great flexibility in manoeuvring the vehicle at low speed (when parking, in traffic jams, ...).

With the engine at idle, parking brake released and position **D**, **M** or **R** selected, the **vehicle moves** as soon as you take your foot off the brake pedal (even without pressing the accelerator).

For your safety, this function will be activated only if you press the brake pedal when changing from forward drive to reverse.

It is deactivated on opening the driver's door. Closing the door then pressing the brake or accelerator pedal reactivates the function.

6

- ! Never leave children inside the vehicle without supervision when the engine is running.

## Manual operation

- ☞ Select position **M** for **sequential** changing of the six gears.
- ☞ Pull towards the **+** sign and release to change up a gear.
- ☞ Push towards the **-** sign and release to change down a gear.

It is only possible to change from one gear to another if the vehicle speed and engine speed permit; otherwise, the gearbox will operate temporarily in automatic mode.



**D** disappears and the gears engaged appear in succession in the instrument panel.

If the engine speed is too low or too high, the gear selected flashes for a few seconds, then the actual gear engaged is displayed.

It is possible to change from position **D** (automatic) to position **M** (manual) at any time. When the vehicle is stationary or moving very slowly, the gearbox selects gear **M1** automatically.

The sport and snow programmes do not operate in manual mode.

## Invalid value during manual operation



This symbol is displayed if a gear is not engaged correctly (gear selector between two positions).

## Stopping the vehicle

Before switching off the engine, you can engage position **P** or **N** to place the gearbox in neutral.

In both cases, apply the parking brake to immobilise the vehicle, unless it is programmed to automatic mode.

- i** If the selector lever is not in position **P**, when the driver's door is opened or approximately 45 seconds after the ignition is switched off, there is an audible signal and a message appears.
  - ☞ Return the selector lever to position **P**; the audible signal stops and the message disappears.

## Operating fault

**SERVICE** With the ignition on, a message appears in the instrument panel screen to indicate a gearbox fault.

In this case, the gearbox switches to back-up mode and is locked in 3rd gear. You may feel a substantial knock when changing from **P** to **R** and from **N** to **R**. This will not cause any damage to the gearbox. Do not exceed 62 mph (100 km/h), local speed restrictions permitting.

Have it checked by a PEUGEOT dealer or a qualified workshop.

- !** You risk damaging the gearbox:
- if you press the accelerator and brake pedals at the same time,
  - if you force the lever from position **P** to another position when the battery is flat.



To reduce fuel consumption when stationary for long periods with the engine running (traffic jam...), position the selector lever at **N** and apply the parking brake, unless it is programmed in automatic mode.

# Dynamic pack (Driver Sport Pack)

This pack conditions:

- the visual ambience, with specific back-lighting for the instrument panel,
- the acoustic ambience of the engine,
- the power assistance for the steering,
- the acceleration,
- the information to the driver in the instrument panel on dynamic settings.

**i** With an automatic gearbox, gear changes are faster.

**i** This function is only available when Park Assist is not selected and snow mode in the automatic gearbox is not selected.

If Park Assist is switched on, this automatically deactivates the function.

**i** The telemetry data (longitudinal and lateral acceleration, power produced, turbocharger pressure, ...) are given as an indication only.

## Activation



☞ Press and hold the button until the back-lighting in the instrument panel changes. The LED in the button stays on.

**i** If the LED flashes, activation is not possible (for example if Park Assist or snow mode is selected) and so the back-lighting returns to its normal mode. If the LED continues flashing for a long time, contact a PEUGEOT dealer or a qualified workshop.

## Display



☞ Press the end of the wiper control stalk to display in the instrument panel the different information on dynamic settings.

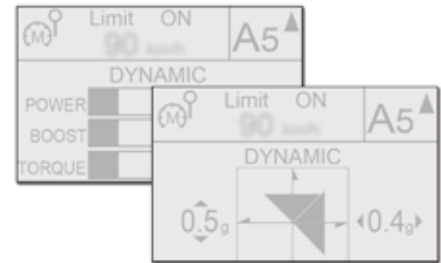

☞ Press repeatedly to go from one screen to another.

6

## Stop & Start

The Stop & Start system puts the engine temporarily into standby - STOP mode - during stops in the traffic (red lights, traffic jams, etc.). The engine restarts automatically - START mode - as soon as you want to move off.

The restart takes place instantly, quickly and silently.

Perfect for urban use, the Stop & Start system reduces fuel consumption and exhaust emissions as well as the noise level when stationary.

### Operation

#### Going into engine STOP mode



The "ECO" warning lamp comes on in the instrument panel and the engine goes into standby automatically:

- **With a manual gearbox**, with the speed below 12 mph (20 km/h) or with the vehicle stationary (depending on the engine), when you put the gear lever into neutral and release the clutch pedal.
- **With an automatic gearbox**, vehicle stationary, when you press the brake pedal or place the gear selector lever in position **N**.

#### Stop & Start time counter

(minutes / seconds or hours / minutes)



A time counter calculates the time spent in STOP mode during a journey.

It resets to zero every time the ignition is switched on.



For your comfort, during parking manoeuvres, STOP mode is not available for a few seconds after coming out of reverse gear.

The Stop & Start system does not affect the functionality of the vehicle, such as for example, braking, power steering... A slight delay between the vehicle stopping and the engine cutting out may be noticed.



Never refuel with the engine in STOP mode; you must switch off the ignition.

## Special cases: STOP mode not available

STOP mode is not invoked principally when:

- the vehicle is on a steep slope (up or down),
- the driver's door is open,
- the driver's seat belt is not fastened,
- the vehicle has not exceeded 6 mph (10 km/h) since the last engine start by the driver,
- the electric parking brake is applied or being applied,
- the engine is needed to maintain a comfortable temperature in the passenger compartment,
- demisting is active,
- some special conditions (battery charge, engine temperature, braking assistance, ambient temperature...) where the engine is needed to assure control of a system.



In this case, the "ECO" warning lamp flashes for a few seconds then goes off.

**This operation is perfectly normal.**

## Going into engine START mode



The "ECO" warning lamp goes off and the engine starts automatically:

- **With a manual gearbox**, when you fully depress the clutch pedal.
- **With an automatic gearbox**:
  - gear selector in position **D** or **M**, when you release the brake pedal,
  - or gear selector in position **N** and brake pedal released, when you place the gear selector in position **D** or **M**,
  - or when you engage reverse.

## Special cases: START invoked automatically

START mode is invoked automatically when:

- you open the driver's door,
- you unfasten the driver's seat belt,
- the speed of the vehicle exceeds 16 mph (25 km/h) or 2 mph (3 km/h) (depending on the engine) with a manual gearbox,
- the speed of the vehicle exceeds 2 mph (3 km/h) with an automatic gearbox,
- the electric parking brake is being applied,
- some special conditions (battery charge, engine temperature, braking assistance, ambient temperature...) where the engine is needed for control of a system.



In this case the "ECO" warning lamp flashes for a few seconds, then goes off.

**This operation is perfectly normal.**

## Deactivation / Reactivation



At any time, press the "**ECO OFF**" switch to deactivate the system. This is confirmed by the switch warning lamp coming on accompanied by a message.

**!** If the system has been deactivated in STOP mode, the engine restarts immediately.

Press the "**ECO OFF**" switch again. The system is active again; this is confirmed by the switch warning lamp going off, accompanied by a message.

**i** The system is reactivated automatically at every new engine start by the driver.

## Operating fault



In the event of a fault with the system, this warning lamp comes on continuously. Have it checked by a PEUGEOT dealer or a qualified workshop.

In the event of a fault in STOP mode, the vehicle may stall.

All of the instrument panel warning lamps come on.

Depending on version, an alert message may also be displayed, asking you to place the gear lever in position **N** and put your foot on the brake pedal.

You must switch off the ignition, then start the engine again.

## **!** Opening the bonnet



Before doing anything under the bonnet, deactivate the Stop & Start system to avoid the risk of injury related to an automatic change to START mode.

## **!** Driving on flooded roads

Before driving through a flooded road, it is strongly recommended that you deactivate the Stop & Start system. For more information on **Driving advice**, particularly on flooded roads, refer to the corresponding section.

**!** The Stop & Start system requires a 12 V battery of a special specification. All work on this type of battery must be carried out only by a PEUGEOT dealer or a qualified workshop. For more information on the **12 V battery**, refer to the corresponding section.

# Memorising speeds

## Touch screen

This function allows speeds to be saved, which can then be offered to set the two systems: the speed limiter (to limit the speed of the vehicle) or the cruise control (for a vehicle cruising speed).

You can memorise up to six speed settings for each of the two systems. By default, some speed settings are already memorised.

## Memorising

This function is accessible in the touch screen.



- Select "**Speed settings**" in the "**Driving assistance**" menu.



As a safety measure, the driver must carry out these operations when stationary.



- Select the system for which you want to memorise new speed settings:



- speed limiter

or



- cruise control.

- Press the button corresponding to the speed setting you want to modify.

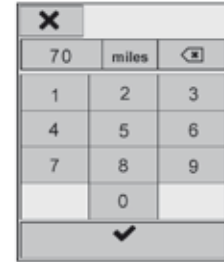

- Enter the new value using the numerical keypad and confirm.
- Confirm to save the modification and quit the menu.

## Speed limiter "LIMIT"

System which prevents the vehicle from exceeding the speed programmed by the driver.

Once the programmed speed limit is reached, additional pressure on the accelerator pedal has no effect.

**Switching on** the speed limiter requires a programmed speed of at least 20 mph (30 km/h).

The speed limiter is **paused** by operation of the control.

The programmed speed can be exceeded temporarily by pressing the accelerator firmly beyond the point of resistance.

To return to the programmed speed, simply release the accelerator pedal until the vehicle returns to the programmed speed limit.

**i** The programmed speed remains in the memory when the ignition is switched off.

**!** The speed limiter cannot, in any circumstances, replace the need to observe speed limits, nor can it replace the need for vigilance on the part of the driver.

### Steering mounted controls



1. Select speed limiter mode.
2. Decrease programmed speed.
3. Increase programmed speed.
4. Speed limiter on / pause.
5. Display the list of memorised speeds (on versions with touch screen tablet).

**i** For more information on **Memorising speeds**, refer to the corresponding section.

### Displays in the instrument panel

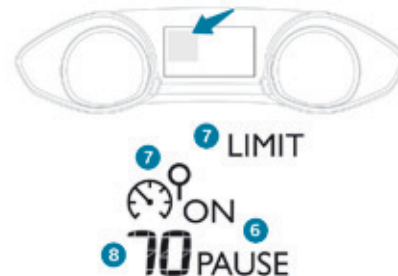

6. Speed limiter on / pause indication.
7. Speed limiter mode selection indication.
8. Programmed speed setting.



## Switching on / Pause

- ☞ Turn the thumbwheel **1** to the "**LIMIT**" position: the speed limiter mode is selected but is not switched on (Pause).
- ☞ Switch the speed limiter back on by pressing button **4**, if the speed displayed is suitable (by default, the last speed programmed).
- ☞ You can temporarily stop the speed limiter by pressing button **4** again: the display confirms that it has been stopped (Pause).

## Adjusting the speed limiter setting

You do not have to switch the speed limiter on in order to set the speed.

Once the function is selected, you can modify the speed setting by:

- using buttons **2** and **3**, increasing or decreasing the speed displayed:
  - ☞ by successive short presses, to modify by + or - 1 mph (1 km/h),
  - ☞ by a maintained press, to modify in steps of + or - 5 mph (5 km/h).

- pressing button **5**:
  - ☞ the six speeds memorised are displayed in the touch screen,
  - ☞ press the button corresponding to the speed limit chosen. The value is displayed in the instrument panel. The selection screen closes after a few moments.



## Temporarily exceeding the programmed speed

☞ Press **firmly** on the accelerator pedal, going beyond the **point of resistance**, to exceed the programmed speed limit.

The speed limiter is deactivated temporarily and the displayed programmed speed flashes. An audible signal accompanies the flashing of the programmed speed when exceeding the speed is not due to an action by the driver (steep hill...).

As soon as the vehicle's speed returns to the programmed value, the limiter operates again: the display of the programmed speed becomes steady again.

## Switching off

☞ Turn the wheel **1** to the "**0**" position. The display of speed limiter information disappears.

## Operating fault

Flashing of the dashes indicates a fault with the speed limiter.

Have it checked by a PEUGEOT dealer or a qualified workshop.



- !** On sharp acceleration, as when descending a steep hill, the speed limiter will not be able to prevent the vehicle from exceeding the programmed speed. The limiter is temporarily deactivated and the displayed programmed speed flashes. An audible signal accompanies the flashing of the programmed speed when exceeding the speed is not due to an action by the driver. The use of mats not approved by PEUGEOT may interfere with the operation of the speed limiter. To avoid any risk of jamming of the pedals:
- ensure that the mat is secured correctly,
  - do not fit one mat on top of another.

# Cruise control "CRUISE"

System which automatically maintains the speed of the vehicle at the value programmed by the driver, without any action on the accelerator pedal.

The cruise control is **switched on** manually: it requires a minimum vehicle speed of 25 mph (40 km/h).

With a manual gearbox, third or fourth gear (depending on engine) or higher must be engaged.

With an automatic gearbox, second gear or higher must be engaged.

The cruise control is **paused** manually or by pressing the brake or clutch pedal or on triggering of the ESC system for safety reasons.

It is possible to exceed the programmed speed temporarily by pressing the accelerator pedal. To return to the programmed speed, simply release the accelerator pedal until the programmed cruise speed is reached again.

**i** Switching off the ignition cancels any programmed speed value.

**!** The cruise control system cannot, in any circumstances, replace the need to observe speed limits, nor can it replace the need for vigilance on the part of the driver. You are advised to keep your feet near the pedals at all times.

## Steering mounted controls



1. Select cruise control mode.
2. Set the current speed as the speed setting / Decrease the speed setting.
3. Set the current speed as the speed setting / Increase the speed setting.
4. Pause / resume cruise control.
5. Display the list of memorised speeds.

**i** For more information on **Memorising speeds**, refer to the corresponding section.

## Displays in the instrument panel



6. Cruise control pause / resume indication.
7. Cruise control mode selection indication.
8. Programmed speed setting.

## Switching on / Pause

- ☞ Turn wheel **1** to the "**CRUISE**" position: the cruise control mode is selected but is not switched on (Pause).
- ☞ Press button **2** or **3**: your vehicle's current speed becomes the cruise speed.

The cruise control is activated (ON).

Once switched on, you can pause the cruise control at any time by pressing button **4**: the screen confirms the pause.

## Modification of the cruise speed setting

If the cruise control is switched on, you can then modify the cruise speed in one of the following ways:

- using buttons **2** or **3**:
  - ☞ by successive short presses, to modify the speed by + or - 1 mph (km/h),
  - ☞ by a long press, to modify the speed in steps of + or - 5 mph (km/h),



- pressing button **5**:
  - ☞ the six memorised speeds are displayed in the touch screen,
  - ☞ choose a value: it is displayed in the instrument panel.

The selection screen closes after a few moments.  
The modification is then accepted.

## Exceeding the programmed speed

If the programmed speed is exceeded, the displayed speed flashes.

Once the vehicle returns to the programmed speed, the display becomes steady again.

## Switching off

- ☞ Turn wheel **1** to the "**0**" position.  
The display of information related to the cruise control disappears.

## Operating fault

Flashing of the dashes indicates a fault with the cruise control.

Have it checked by a PEUGEOT dealer or a qualified workshop.



**!** When the cruise control is switched on, be careful if you maintain the pressure on one of the programmed speed changing buttons: this may result in a very rapid change in the speed of your vehicle.

Do not use the cruise control on slippery roads or in heavy traffic.

On a steep descent, the cruise control will not be able to prevent the vehicle from exceeding the programmed speed.

On steep climbs or when towing, the programmed speed may not be reached or maintained.

The use of mats not approved by PEUGEOT may interfere with the operation of the cruise control.

To avoid any risk of jamming of the pedals:

- ensure that the mat is secured correctly,
- never fit one mat on top of another.

# Dynamic cruise control "CRUISE"

This system allows the vehicle's speed to be maintained at a value set by the driver.

In addition it allows (when circumstances permit) an inter-vehicle time that you have selected to be maintained between your vehicle and the one in front.

## Switching between the types of cruise control

If you want to use the "standard" cruise control, it is possible to deactivate the dynamic cruise control in the touch screen.

The cruise control selection thumbwheel must be in the "CRUISE" position, otherwise the choice will not be taken into account.



Press the button to change from dynamic cruise control to "standard" cruise control and vice-versa.

**i** For more information on the **Cruise control**, refer to the corresponding section.

The state of the system is memorised on switching off the ignition.

## Principles of operation

Using a radar with a range of about 100 metres, located at the front of the vehicle, this system detects a vehicle running in front of your vehicle.

It automatically adapts the speed of your vehicle to that of the vehicle in front.

If the vehicle in front is running more slowly, the system progressively reduces the speed of your vehicle using just engine braking (as if the driver had pressed the "-" button).

If your vehicle is too close to, or approaching too quickly the vehicle in front, the dynamic cruise control is automatically deactivated. The driver is then alerted by an audible signal, accompanied by a message.

If the vehicle in front accelerates or changes lane, the dynamic cruise control progressively accelerates your vehicle to return to the programmed speed.

If the driver operates a direction indicator to overtake a slower vehicle, the dynamic cruise control allows your vehicle to temporarily approach the vehicle in front to assist the overtaking manoeuvre, though never exceeding the programmed speed.

**i** The dynamic cruise control operates by day and at night, in fog or moderate rainfall.

**i** The selection of this system deactivates the display of inter-vehicle time.

**!** The system does not act on the braking system, but works only with engine braking. The regulation range is limited: there will no longer be any adjustment of speed if the difference between the programmed speed setting and the speed of the vehicle in front becomes too great.

**!** If the difference between the programmed speed setting and the speed of the vehicle in front is too great, the speed cannot be adjusted: the cruise control is automatically deactivated.

## General points

The dynamic cruise control is **switched on** manually, it requires that the speed of the vehicle be between 25 mph (40 km/h) and 90 mph (150 km/h).

With a manual gearbox, third or fourth gear (depending on engine) or higher must be engaged.

With an automatic gearbox, second gear or higher must be engaged.

If the cruise speed setting is above 90 mph (150 km/h), the dynamic cruise control switches to normal cruise control mode (without automatic adjustment of the safety inter-vehicle distance).

**!** The dynamic cruise control cannot in any circumstances replace the observation of speed limits, nor the need for the vigilance on the part of the driver. It is recommended that you always keep your feet close to the pedals.

The dynamic cruise control can be **paused** manually with the control, or automatically:

- by pressing the brake or clutch pedal,
- in the event of operation of the ESC, for safety reasons,
- in the event of an action on the electric parking brake control,
- when an inter-vehicle time threshold is reached (calculated according to the relative speeds of your vehicle and the vehicle in front and the inter-vehicle time setting chosen),
- when the distance between your vehicle and the one in front becomes too small,
- when the speed of the vehicle in front is too low,
- when the speed of your vehicle becomes too low.

**i** The inter-vehicle time setting is memorised when switching off the ignition.

## Steering mounted controls



1. Select cruise control mode.
2. Set the current speed as the cruise speed setting / Reduce the cruise speed setting.
3. Set the current speed as the cruise speed setting / Increase the cruise speed setting.
4. Pause / resume cruise control.
5. Display the list of memorised speeds and adjust the inter-vehicle time.

**i** For more information on **Memorising speeds**, refer to the corresponding section.

## Displays in the instrument panel

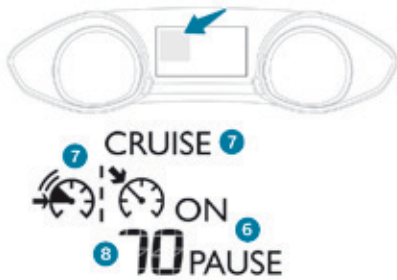

6. Indication of cruise control pause / resume.
7. Indication of selection of cruise control mode, or vehicle speed adjustment phase.
8. Programmed speed setting.

## Switching on

The dynamic cruise control must be selected in the "Driving assistance" menu.

- ☞ Turn the wheel **1** to the "CRUISE" position: cruise control mode is selected, but not started (Pause).
- ☞ Press one of the buttons **2** or **3**: the current speed of your vehicle becomes the cruise speed setting.

The cruise control is activated (ON).

By default, the inter-vehicle time is set at 2 seconds.

Otherwise, the last setting made will be used when switching on the system.

## Modification of the cruise speed

### Buttons 2 and 3

If the cruise control is on, you can modify the speed:

- ☞ by successive short presses, to modify in steps of + or - 1 mph (km/h),
- ☞ by a maintained press, to modify in steps of + or - 5 mph (km/h).

As a precaution, it is recommended that you select a cruise speed setting close to the current speed of your vehicle.



## Modification of the cruise control speed and/or the inter-vehicle time

### Button 5 (MEM)

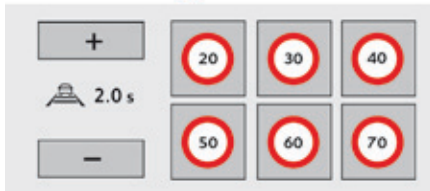

Press button **5**, the six memorised speeds and the inter-vehicle time setting are displayed in the touch screen.

- ☞ Choose a speed setting: it is displayed in the instrument panel,
- ☞ press or the "+" or "-" button to choose a new inter-vehicle time setting between 2.5 seconds and 1 second.

This setting remains memorised, whatever the state of the system.

The selection screen closes after a few moments. The modifications are then accepted.

**i** In the event of the presence of a vehicle detected by the radar, if the speed selected is much higher than the speed of that vehicle, the system is not activated and the alert message "Activation not possible, conditions unsuitable" is displayed until driving conditions are safe to allow activation of the system.

## Exceeding the programmed speed











It is possible to exceed the programmed speed temporarily by depressing the accelerator pedal.

Simply release the accelerator pedal to return to the programmed speed.

If the programmed setting is unintentionally exceeded, descending a steep hill for example, the speed setting in the instrument panel flashes as a warning.

## Driving situations and associated alerts

The following table describes the alerts and the messages displayed for the different driving situations. The display of these alerts is not sequential.

| Symbol  | Display in the instrument panel   | Associated message       | Comments   |
|---|---|--------------------------|--|
|  |  |                          | No vehicle detected: the system operates as a standard cruise control.   |
|  |  |                          | Detection of a vehicle, at the limit of the range of the radar: the system operates as a standard cruise control.  |
|  |  | "SPEED ADJUSTED"         | Detection of a vehicle that is too close or running at a speed lower than your vehicle's cruise speed setting. The system uses engine braking to slow your vehicle (within a limit of 20 mph (30 km/h)) and then hold it at the speed of the vehicle in front so as to observe the programmed inter-vehicle time. When automatically slowing down behind a vehicle, your true speed may be higher than the "adjusted speed" displayed. |
|  |  | "SPEED ADJUSTED"         | When the adjusted speed reaches the limit of regulation (speed setting less than 20 mph (30 km/h)), the adjusted speed flashes together with the speed setting to signal that automatic deactivation of the system is imminent.  |
|  |  | "Cruise control paused". | If the system exceeds the limit of speed adjustment possible by the system and in the absence of any reaction by the driver (operation of the direction indicator, change of lane, reduction of the speed of the vehicle), the system is automatically paused. The display of the deactivation message is accompanied by an audible signal.  |



When the dynamic cruise control is automatically paused, it can only be reactivated when safe conditions are restored. The message "Activation not possible, conditions unsuitable" is displayed while reactivation is not possible.

When the conditions allow, it is recommended that the function be reactivated by pressing button **2** (SET+) or **3** (SET-), which will make the current speed of your vehicle the new cruise speed setting, rather than by pressing button **4** (on/pause) which reactivates the cruise control using the old cruise speed setting, which may be very different from the current speed of your vehicle.

## Limits of operation

The speed regulation range is limited to a maximum difference of 20 mph (30 km/h) between the speed setting and the speed of the vehicle in front.

Above this, the system goes into pause if the safe distance becomes too low.

The dynamic cruise control uses only engine braking to slow the vehicle. Consequently the vehicle loses speed slowly, as when releasing the accelerator pedal.

The system is paused automatically:

- if the vehicle in front slows down too much or too suddenly, and the driver does not brake,
- if a vehicle comes between your vehicle and the vehicle in front,
- if the system does not slow the vehicle enough to continue to maintain a safe distance, for example when descending a steep hill.

As the radar's field of view is quite narrow, it is possible that the system may not detect:



- vehicles of reduced width, such as motorcycles,



- vehicles not running in the middle of the lane,



- vehicles entering a corner,
- vehicles changing lane at the last moment.



The cruise control does not take account of:

- stationary vehicles,
- vehicles driving in the opposite direction.

## Operating fault

In the event of a fault with the dynamic cruise control, you are alerted by an audible signal and display of the message "Driving aid functions fault".

Have the system checked by a PEUGEOT dealer or a qualified workshop.



- i The operation of the radar, located in the front bumper, may be disturbed in certain weather conditions, for example: with accumulations of snow, ice, mud, ...  
Clean the front bumper, removing the snow, mud, ...

- ! When the cruise control is working, take care if making a maintained press on one of the cruise control programmed speed modification buttons: this can lead to a very quick change in the speed of your vehicle.  
Do not use the dynamic cruise control on slippery surfaces or in heavy traffic.  
When descending a steep hill, the cruise control may not be able to prevent the vehicle from exceeding the programmed speed.  
When ascending a steep hill or when towing, it might not be possible to attain or maintain the programmed speed.

- The use of mats not approved by PEUGEOT may interfere with the operation of the dynamic cruise control. To avoid any risk of jamming the pedals:
- ensure that mats are secured correctly,
  - never fit one mat on top of another.

## Display of inter-vehicle time

Using a radar located at the front of the vehicle, this system helps the driver maintain a safe distance between their vehicle and the one in front, by displaying the current inter-vehicle time in the instrument panel.

This is the time interval, expressed in seconds, that separates two vehicles in line.

The recommended safe value is about 2 seconds.

Refer to the legislation or highway code in force in your country.



- i** The system is active in a speed range between 42 and 93 mph (70 and 150 km/h). Stationary vehicles and certain other road users (such as bicycles for example) are not detected. The system displays inter-vehicle time values of between 3 seconds and 0.5 of a second. Below 0.5 of a second, the value displayed is maintained at this level, even if the true inter-vehicle time is less.

- !** The measurement is displayed for information only: the system takes no action on the vehicle. This system does not in any circumstances replace the need for vigilance on the part of the driver, who must remain in control of the vehicle at all times. The system is not designed for urban use nor for more dynamic driving (bends, acceleration, harsh braking...) but rather when driving at a steady speed.

## Activation / deactivation\*

Activation of the system is done in the "Driving assistance" menu, with the engine running.



- ☞ Press this button, the indicator lamp comes on.

The state of the system is memorised when the ignition is switched off.





## Conditions for display

The dynamic cruise control must not be selected (the dynamic cruise control information is displayed instead of that for the inter-vehicle time).

\* Depending on version.

## Displays

Once the speed conditions are met, a symbol is displayed in the instrument panel.

| Symbol  | Associated message                    | Comments  |
|---|---------------------------------------|---|
|  |                                       | No vehicle detected by the radar.   |
|  |                                       | A vehicle is detected but the inter-vehicle time is more than 3 seconds. No value is displayed.   |
|  |                                       | A vehicle is detected. The inter-vehicle time is 3 seconds or less. The minimum value displayed is 0.5 seconds, even if the true inter-vehicle time is lower.   |
|  | "SYSTEM INACTIVE: Speed unsuitable"   | If the speed of your vehicle is outside the operating range.<br>Where the speed is not suitable, a message is displayed while the speed is outside limits (below 42 mph (70 km/h) or above 93 mph (150 km/h), approximately). However, when decelerating, the system is deactivated below 27 mph (45 km/h). |
|  | "SYSTEM INACTIVE: Visibility reduced" | The system switches to standby automatically if the sensor does not detect the vehicle in front correctly (very difficult weather conditions, sensor out of adjustment, ...).   |

## Operating limits

The vehicle being followed may not be detected in certain conditions such as, for example:

- when turning,
- when changing lane,
- when the vehicle in front is out of the range of the sensor (maximum range: around 100 m).



## Operating fault

### SERVICE

In the event of a fault with the system, this warning lamp is displayed accompanied by a message.

Have the system checked by a PEUGEOT dealer or a qualified workshop.

**i** At the first use of the system after repair, a message may be displayed indicating that the system is initialising. The system is not available while this is in progress. As soon as the message disappears the system is operational again. If the message does not disappear, contact a PEUGEOT dealer or a qualified workshop.

**i** The operation of the radar, located in the front bumper, may be disturbed in certain weather conditions, for example: with accumulations of snow, ice, mud, ...  
Clean the front bumper, removing the snow, mud, ...

# Emergency collision alert system and emergency collision braking system

## Emergency collision alert

System providing a warning to the driver that their vehicle is at risk of collision with the vehicle in front.



**i** This system operates from 20 mph (30 km/h), only when other vehicles are running in the same direction as your vehicle; the system does not detect stationary objects. A radar is fitted at the front of the vehicle.

**!** This system has been designed to improve driving safety. The driver must constantly monitor the traffic conditions, to assess the distance and relative speed of other vehicles. The collision risk alert system does not replace the need for vigilance on the part of the driver.

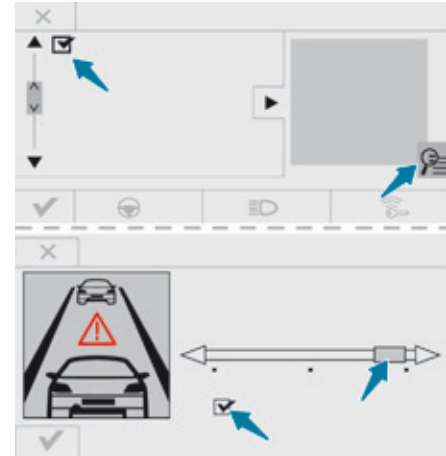

The emergency collision alert system can be activated or deactivated by the driver. From the secondary page of the "**Driving assistance**" menu:

- ☞ Select the "**Vehicle settings**" menu.
- ☞ Check the "**Collision risk alert and auto braking**" line and confirm.



## Setting the thresholds for the alert

The alert thresholds determine how you want to be alerted to the presence of a vehicle running in front of you.

You can choose from three thresholds:

- **"Distant"**, to be given an early alert (cautious driving).
- **"Normal"**.
- **"Close"**, to be given a later alert (sporty driving).



From the secondary page of the **"Driving assistance"** menu:

- ☞ Select the **"Vehicle settings"** menu.
- ☞ Check the **"Collision risk alert and auto braking"** line.



- ☞ Press on the magnifying glass.

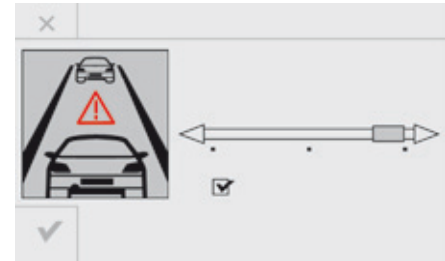

- ☞ Modify the alert threshold and press on **"Finish"** to memorise the threshold and leave the menu.
- ☞ Press on **"Confirm"** to save the change.

## Alerts

According to the collision risk detected by the system and the alert threshold chosen, different levels of alert can be given.



**Level 1:** visual alert only (orange) indicating that the vehicle in front is very close. The message "**Vehicle close**" is displayed.

This level of alert is based on the inter-vehicle time between your vehicle and the one in front.



**Level 2:** visual (red) and audible alerts indicating that a collision is imminent. The message "**Brake!**" is displayed.

This level of alert is based on a time before collision. It takes account of the vehicle dynamics, the speed of your vehicle and the speed of the vehicle in front, the driving conditions, the situation with your vehicle (cornering, pedals pressed, etc.) to trigger the alert at the right moment.

**!** The emergency collision alert system does not replace the need for vigilance on the part of the driver.

**i** The change from one level of alert to the next takes place if the driving conditions do not change (speed unchanged, no change of lane...).

**i** If the speed of your vehicle is too high when approaching another vehicle, the first level of alert may not be displayed: the level 2 alert may be displayed directly.

On the other hand, the level 1 alert is never displayed with the "close" triggering threshold 3.

Severe weather conditions (very heavy rain, accumulations of snow in front of the radar) may interfere with the operation of the system, resulting in the display of this message "**SYSTEM INACTIVE: Reduced visibility**". The system will remain unavailable until the message disappears.

## Emergency collision braking system

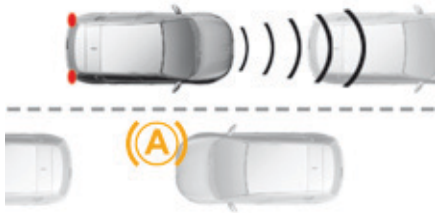

Emergency collision braking is a system that aims to reduce the speed of a frontal collision if the driver does not take action, using radar type detection and acting on the vehicle's braking system.

### Conditions for activation

Emergency collision braking only operates in the following conditions:

- engine running
- no fault in the electronic stability system,
- speed at least 12 mph (20 km/h),
- engine speed sufficiently high.

On the other hand, the radar type of detection cannot act on the braking system in a tight corner.



From the secondary page of the "**Driving assistance**" menu:

- ☞ Select the "**Vehicle settings**" menu.
- ☞ Check the "**Collision risk alert and auto braking**" line.



- ☞ Press the magnifying glass.

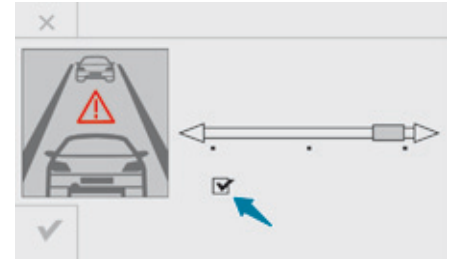

- ☞ Modify the alert threshold and check the "**Auto braking**" line.
- ☞ Press on "**Finish**" to memorise the threshold and leave the menu.
- ☞ Press on "**Confirm**" to save the change.



This warning lamp flashes when your vehicle "starts" to brake but will not in any circumstance completely stop the vehicle.



You should continue to press firmly on the brake pedal until the vehicle comes to a complete stop.



When the emergency collision braking system is not activated, this warning lamp is on fixed.

## Operating fault

**SERVICE** In the event of a fault, you are alerted by the display of the Service warning lamp, accompanied by a message. Consult a PEUGEOT dealer or a qualified workshop.



**i** The operation of the radar, located in the front bumper, may be disturbed in certain weather conditions, for example: with accumulations of snow, ice, mud, ...  
Clean the front bumper, removing the snow, mud, ...

# Blind spot monitoring system



This driving assistance system warns the driver of the presence of another vehicle in the blind spot angle of their vehicle (areas hidden from the driver's field of vision), as soon as this presents a potential danger.



A warning lamp appears in the door mirror on the side in question:

- immediately, when being overtaken,
- after a delay of about one second, when overtaking a vehicle slowly.

## Operation



Activation of the system is done in the "**Driving assistance**" menu of the touch screen.



Press this button (depending on version) to activate the system; the associated indicator lamp comes on.



This indicator lamp comes on in the instrument panel.

Sensors fitted in the front and rear bumpers monitor the blind spots.



This system is designed to improve safety when driving and is in no circumstances a substitute for the use of the interior rear view mirror and door mirrors. It is the driver's responsibility to constantly check the traffic, to assess the distances and relative speeds of other vehicles and to predict their movements before deciding whether to change lane. The blind spot monitoring system does not replace the need for vigilance on the part of the driver.

The alert is given by a warning lamp which comes on in the door mirror on the side in question as soon as a vehicle - car, lorry, bicycle - is detected and the following conditions are fulfilled:

- all the vehicles are moving in the same direction and on adjacent lanes,
- the speed of your vehicle is between 7 and 87 mph (12 and 140 km/h),
- when you overtake a vehicle with a speed difference of less than 6 mph (10 km/h),
- when a vehicle overtakes you with a speed difference of less than 16 mph (25 km/h),
- the traffic is flowing normally,
- in the case of an overtaking manoeuvre, if this is prolonged and the vehicle being overtaken remains in the blind spot,
- you are driving on a straight or slightly curved road,
- your vehicle is not pulling a trailer, a caravan...

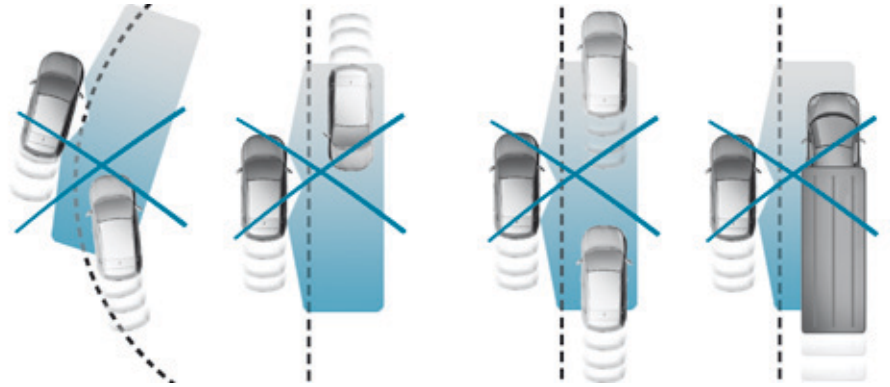

No alert will be given in the following situations:

- in the presence of immobile objects (parked vehicles, barriers, street lamps, road signs...),
- with vehicles moving in the opposite direction,
- driving on a winding road or a sharp corner,

- when overtaking (or being overtaken by) a very long vehicle (lorry, coach...) which is at the same time detected at the rear in the blind spot angle and present in the driver's forward field of vision,
- in very heavy traffic: vehicles detected in front and behind are confused with a lorry or an immobile object,
- when overtaking quickly.



- To deactivate the system, press this button again; its indicator lamp goes off as well as the associated indicator in the instrument panel (depending on version).

The state of the system remains in memory on switching off the ignition.

- The system is automatically deactivated when towing with a towbar approved by PEUGEOT.

## Operating fault

Depending on version:



- this warning lamp flashes for a few seconds then goes off,



- this symbol changes to alert mode, its warning lamp flashes for a few moments, then goes off.

Have it checked by a PEUGEOT dealer or a qualified workshop.

- The system may suffer temporary interference in certain weather conditions (rain, hail...). In particular, driving on a wet surface or moving from a dry area to a wet area can cause false alerts (for example, the presence of a fog of water droplets in the blind spot angle is interpreted as a vehicle). In bad or wintry weather, ensure that the sensors are not covered by mud, ice or snow. Take care not to cover the warning zone in the door mirrors or the detection zones on the front and rear bumpers with adhesive labels or other objects; they may hamper the correct operation of the system.

### ! High pressure jet wash

When washing your vehicle, direct the lance at least 30 cm away from the sensors.

## Parking sensors

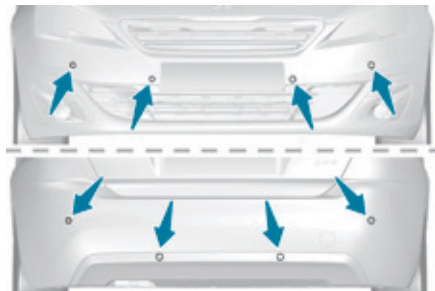

This system indicates the proximity of an obstacle (e.g. pedestrian, vehicle, tree, gate) which comes within the field of detection of sensors located in the bumper. Certain types of obstacle (e.g. stake, roadworks cone) detected initially will no longer be detected at the end of the manoeuvre, if they are located in blind spots in the sensors' field of detection.

**!** This system cannot in any circumstances replace the need for vigilance on the part of the driver.

### Rear parking sensors

The system is switched on by engaging reverse gear.

This is confirmed by an audible signal.

The system is switched off when you come out of reverse gear.

### Audible assistance



The proximity information is given by an intermittent audible signal, the frequency of which increases as the vehicle approaches the obstacle. The sound emitted by the speaker (right-hand or left-hand) indicates the side on which the obstacle is located.

When the distance between the vehicle and the obstacle becomes less than approximately thirty centimetres, the audible signal becomes continuous.

### Visual assistance



This supplements the audible signal by displaying bars in the screen or the instrument panel which move progressively nearer to the vehicle. When the obstacle is near, the "Danger" symbol is displayed.

### Front parking sensors

As an addition to the rear parking sensors, the front parking sensors are triggered when an obstacle is detected in front and the speed of the vehicle is still below 6 mph (10 km/h).

The front parking sensors are interrupted if the vehicle stops for more than three seconds in forward gear, if no further obstacles are detected or when the speed of the vehicle exceeds 6 mph (10 km/h).

**i** The sound from the speakers (front or rear) indicates whether the obstacle is in front or behind.



## Deactivation / Activation of the front and rear parking sensors



The system is deactivated in the "Driving assistance" menu of the touch screen.



Press this button. The indicator lamp in the button comes on.

Pressing this button again reactivates the function. The indicator lamp in the button goes off.

**i** The system will be deactivated automatically if a trailer is being towed or a bicycle carrier is fitted on a towbar (vehicle fitted with a towbar installed in line with the manufacturer's recommendations).

**i** The parking sensors are deactivated while the Park Assist system is measuring a space. For more information on **Park Assist**, refer to the corresponding section.

## Operating fault

Depending on version and when engaging reverse:

### SERVICE

- this warning lamp comes on in the instrument panel and/or a message appears, accompanied by an audible signal,
- this symbol changes to alert mode, its warning lamp flashes for a few moments then stays on and a message appears, accompanied by an audible signal.

Contact a PEUGEOT dealer or a qualified workshop.

**i** In bad or wintry weather, ensure that the sensors are not covered with mud, ice or snow. When reverse gear is engaged, an audible signal (long beep) indicates that the sensors may be dirty. Certain sound sources (motorcycle, lorry, pneumatic drill, etc.) may trigger the audible signals of the parking sensor system.

**!** **High pressure jet wash**  
When washing your vehicle, do not direct the lance within 30 cm of the sensors.

## Reversing camera



The reversing camera is activated automatically when reverse gear is engaged. Depending on version, the image is displayed in the touch screen or the instrument panel.

The reversing camera function may be completed with parking sensors.

**i** The reversing camera cannot in any circumstances replace the need for vigilance on the part of the driver.

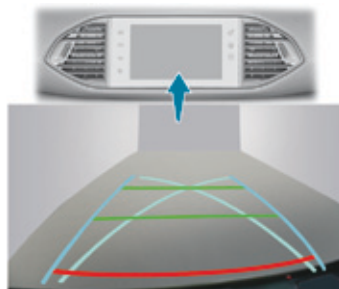

**!** **High pressure jet washing**  
When washing your vehicle, do not direct the lance within 30 cm of the camera lens.

The superimposed representation of guide lines helps with the manoeuvre. They are represented by lines marked "on the ground" and do not allow the position of the vehicle to be determined relative to tall obstacles (for example: other vehicles, ...). Some deformation of the image is normal. It is normal to be able to see part of the number plate at the bottom of the screen.

The blue lines represent the general direction of the vehicle (the difference corresponds to the width of your vehicle without the mirrors). The red lines represent a distance of about 30 cm beyond the edge of your vehicle's rear bumper. The green lines represent distances of about 1 and 2 metres beyond the edge of your vehicle's rear bumper. The turquoise blue curves represent the maximum turning circle.

**i** Opening the tailgate causes the display to disappear.

Clean the reversing camera regularly using a soft, dry cloth.

# Park Assist

This system provides active assistance with parking. It detects a parking space then operates the steering to park in the space. It operates the steering while the driver manages the accelerator, brakes, gears and clutch (manual gearbox). During phases of entry into and exit from a parking space, the system provides visual and audible information to the driver in order to make the manoeuvres safe. It may be necessary to move forwards and backwards more than once.

The driver can take control at any time by gripping the steering wheel.

**!** This manoeuvring assistance system cannot, in any circumstances, replace the need for vigilance on the part of the driver.

The driver must remain in control of their vehicle ensuring that the space remains clear throughout the manoeuvre. In some circumstances, the sensors may not detect small obstacles located in their blind spots.

**i** The Park Assist system cannot work with the engine off.

**P** The Park Assist system provides assistance for the following manoeuvres:

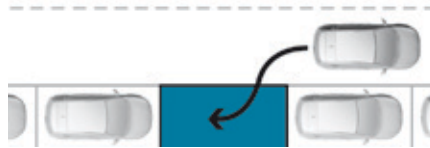

**A.** Entry into a parallel parking space



**B.** Exit from a parallel parking space

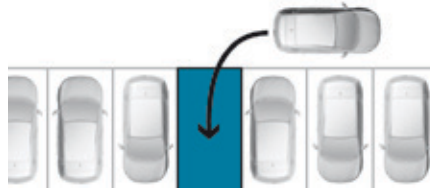

**C.** Bay parking

**!** During a manoeuvre, the steering wheel turns quickly: do not hold the steering wheel, do not place your hands between the spokes of the steering wheel and take care with loose and bulky clothing (scarves, ties, handbags...) - Risk of injury!

**i** When Park Assist is activated, it prevents a change to STOP mode of Stop & Start. In STOP mode, activation of Park Assist restarts the engine.

**i** The Park Assist system takes control of the power steering for a maximum of 4 manoeuvre cycles. The function is deactivated after these 4 cycles. If you think that your vehicle is not positioned correctly, you should then take control of the steering to carry out the manoeuvre.

**!** The sequence of manoeuvres and the driving instructions are displayed in the instrument panel.



The assistance is activated: the display of this symbol and a speed limit indicate that the steering manoeuvres are controlled by the system: do not touch the steering wheel.



The assistance is deactivated: the display of this symbol indicates that the steering manoeuvres are no longer controlled by the system: you must take control of the steering.

**!** You should always check the surroundings of your vehicle before starting a manoeuvre.

**i** The parking sensors function is not available during parking space measurement. It intervenes later when manoeuvring to warn you that your vehicle is approaching an obstacle: the audible signal becomes continuous when the obstacle is less than thirty centimetres away.  
If you have deactivated the parking sensors, they are automatically reactivated during assisted parking manoeuvres.

**!** Activation of Park Assist deactivates the Blind Spot Monitoring System.

## Operation

### Assistance with parallel parking manoeuvres



☞ When you have identified a parking space:



☞ Press this control.

or



☞ Select "**Park Assist**" in the "**Driving assistance**" menu of the touch screen to activate the function.



☞ Limit the speed of the vehicle to a maximum of 12 mph (20 km/h) and select "**Enter parking slot**" in the touch screen.



To enter a parking space, the system does not identify spaces that are clearly smaller or larger than the vehicle.

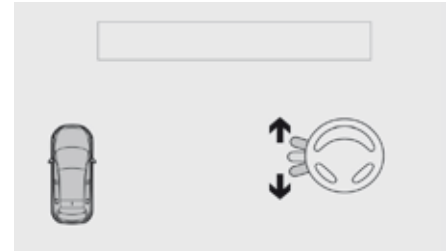

☞ Operate the direction indicator on the parking side chosen to activate the measurement function. You should drive at a distance of between 0.5 m and 1.5 m from the row of parked vehicles.

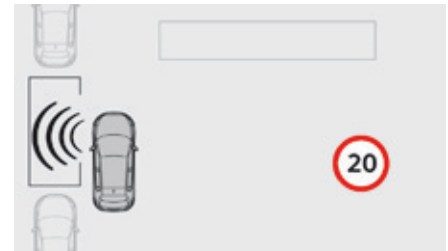

☞ Drive slowly following the instructions until the system finds a free space.



- ☞ Move forwards slowly until a message is displayed, accompanied by an audible signal, asking you to engage reverse gear.

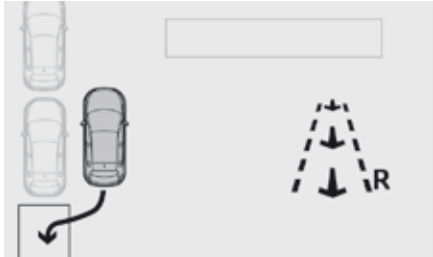

- ☞ Select reverse, release the steering wheel and start moving without exceeding 4 mph (7 km/h).



- ☞ The assisted parking manoeuvre is in progress. Without exceeding 4 mph (7 km/h), move forwards and backwards, aided by the warnings from the "Parking sensors" system, until the indication of the end of the manoeuvre.



- ☞ At the end of the manoeuvre, the operating indicator lamp goes out in the instrument panel, accompanied by a message and an audible signal. The assistance is deactivated: you can take over control.

## Assistance in exiting from a parallel parking space



- ☞ When you want to leave a parallel parking space, start the engine.



- ☞ With the vehicle stationary, press this control.

or



- ☞ Select "**Park Assist**" in the "**Driving assistance**" menu of the touch screen to activate the function.



- ☞ Press on "**Exit parking slot**" in the touch screen.



- ☞ Operate the direction indicator for the exit side chosen.
- ☞ Engage reverse or forward gear and release the steering wheel.

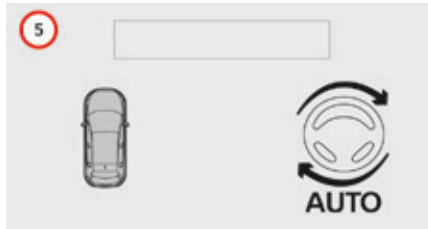

- ☞ The assisted parking manoeuvre is in progress. Without exceeding 3 mph (5 km/h), move forwards and backwards, aided by the warnings from the "Parking sensors" system, until the indication of the end of the manoeuvre.

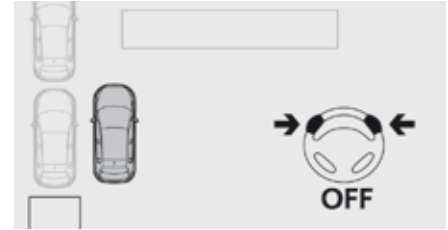

The manoeuvre is complete when the vehicle's front wheels are clear of the parking space. At the end of the manoeuvre, the indicator lamp in the instrument panel goes off, accompanied by a message and an audible signal. The assistance is deactivated: you can take over control.

## Assistance with bay parking manoeuvres



- ☞ Once you have identified a parking zone, press this control at the steering wheel.

or



- ☞ Select "**Park Assist**" in the "**Driving assistance**" menu of the touch screen to activate the function.



- ☞ Limit the speed of the vehicle to a maximum of 12 mph (20 km/h) and select "**Start parking in a bay**" on the touch screen.



- ☞ Operate the direction indicator on the parking side chosen to activate the measurement function. You should drive at a distance of between 0.5 m and 1.5 m from the row of parked vehicles.



- ☞ Drive slowly following the instructions until the system finds a free space.

- i** When several successive bays are found, the vehicle will be directed towards the last one.

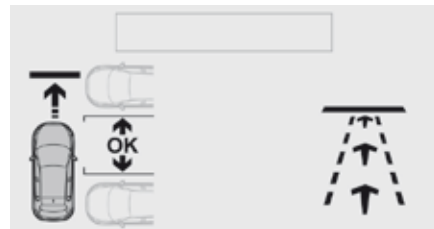

- ☞ Move forwards slowly until a message is displayed, accompanied by an audible signal, asking you to engage reverse gear.



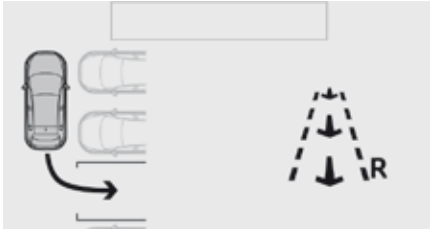

- Select reverse, release the steering wheel and start moving without exceeding 4 mph (7 km/h).

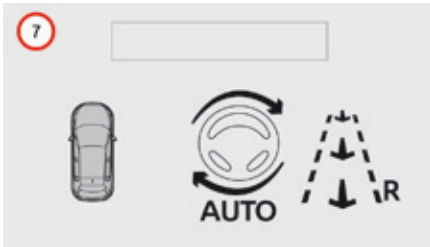

- The assisted parking manoeuvre is in progress. Without exceeding 4 mph (7 km/h), follow the instructions displayed in the instrument panel, aided by the warnings from the "Parking sensors" system, until the indication of the end of the manoeuvre.

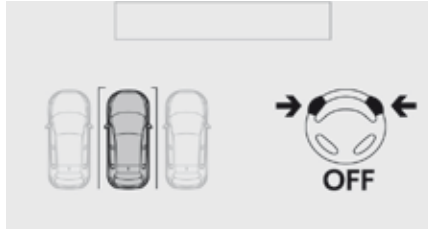

- At the end of the manoeuvre, the operating indicator lamp goes off in the instrument panel, accompanied by a message and an audible signal. The assistance is deactivated: you can take over control.

- During a bay parking manoeuvre, the Park Assist system is automatically deactivated once the rear of the vehicle is within 50 cm of an obstacle.

- During parking and exit from parking manoeuvres, the reversing camera function may come into operation. It facilitates monitoring of the surroundings of the vehicle, by displaying additional information in the instrument panel. For more information on the **Reversing camera**, refer to the corresponding section.

## Deactivation

The system is deactivated by pressing the control.

The system is deactivated automatically:

- on switching off the ignition,
- if the engine stalls,
- if no manoeuvre is started within 5 minutes of selection of the type of manoeuvre,
- after a prolonged stop of the vehicle during a manoeuvre,
- if the road wheel anti-slip regulation (ASR) is triggered,
- if the speed of the vehicle exceeds the stated limit,
- when the driver interrupts movement of the steering wheel,
- after 4 manoeuvre cycles,
- on opening the driver's door,
- if one of the front wheels encounters an obstacle.

The operation indicator lamp goes off in the instrument panel and a message is displayed accompanied by an audible signal.

The driver should then take back control of the vehicle's steering.

If the system is deactivated during a manoeuvre, the driver should reactivate it to repeat the measurement.

## Switching off

The system is switched off automatically:

- when towing a trailer,
- if the driver's door is opened,
- if the speed of the vehicle is above 42 mph (70 km/h).

To switch the system off for a prolonged period, contact a PEUGEOT dealer or a qualified workshop.

## Operating faults

Depending on version:

**SERVICE**

- this warning lamp comes on in the instrument panel and a message appears, accompanied by an audible signal,



- this symbol changes to alert mode, its warning lamp flashes for a few moments, then goes off.

**STOP**

In the event of a fault, the symbol for the button changes to alert mode and the warning lamp flashes for a few moments then goes off.

Contact a PEUGEOT dealer or a qualified workshop.

**i** If the lateral distance between your vehicle and the space is too great, the system may not be able to measure the space. Anything projecting beyond the envelope of the vehicle (long or wide load) is not taken into account by the Park Assist system during a manoeuvre.

**!** In bad weather or in winter, ensure that the sensors are not covered by road dirt, ice or snow. In the event of a fault, have the system checked by a PEUGEOT dealer or a qualified workshop.

# Under-inflation detection

System which automatically checks the pressures of the tyres while driving.

The system monitors the pressures in the four tyres, once the vehicle is moving.

It compares the information given by the four wheel speed sensors with **reference values, which must be reinitialised every time the tyre pressures are adjusted or a wheel changed.**

The system triggers an alert as soon as it detects a drop in the inflation pressure of one or more tyres.



The under-inflation detection system does not replace the need for vigilance on the part of the driver.

This system does not avoid the need to check the tyre pressures (including the spare wheel) every month as well as before a long journey.

Driving with under-inflated tyres impairs road holding, extends braking distances and causes premature tyre wear, particularly under arduous conditions (high loading, high speed, long journey).



The inflation pressures defined for your vehicle can be found on the tyre pressure label.

For more information on the **Identification markings**, refer to the corresponding section.

Tyre pressures should be checked when the tyres are "cold" (vehicle stopped for 1 hour or after a journey of less than 6 miles (10 km) at moderate speeds).

Otherwise (when hot), add 0.3 bar to the pressures shown on the label.



Driving with under-inflated tyres increases fuel consumption.



## Snow chains

The system does not have to be reinitialised after fitting or removing snow chains.

## Under-inflation alert



This is given by fixed illumination of this warning lamp, accompanied by an audible signal and, depending on equipment, the display of a message.

- ☞ Reduce speed immediately, avoid excessive steering movements and sudden braking.
- ☞ Stop the vehicle as soon as it is safe to do so.

**!** The loss of pressure detected does not always cause visible bulging of the tyre. Do not satisfy yourself with just a visual check.

- ☞ In the event of a puncture, use the temporary puncture repair kit or the spare wheel (depending on equipment),
- or
- ☞ if you have a compressor, such as the one in the temporary puncture repair kit, check the pressures of the four tyres when cold,
- or
- ☞ if it is not possible to make this check immediately, drive carefully at reduced speed.

**i** The alert is maintained until the system is reinitialised.

## Reinitialisation

It is necessary to reinitialise the system every time one or more tyre pressures are adjusted, and after changing one or more wheels.

**!** Before reinitialising the system, ensure that the pressures of the four tyres are correct for the use of the vehicle and in line with the recommendations on the tyre pressure label.

The under-inflation alert can only be relied on if the reinitialisation of the system has been done with the pressures in the four tyres correctly adjusted.

The under-inflation detection system does not give a warning if a pressure is incorrect at the time of reinitialisation.

## Touch screen

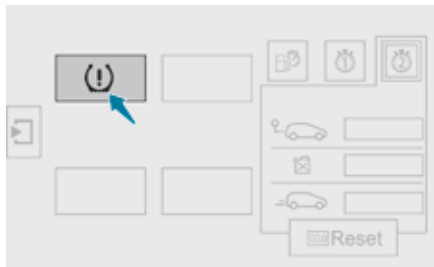

Reinitialisation of the system is done with the ignition on and the vehicle stationary.

- ☞ Select "**Under-inflation initialisation**" in the "**Driving assistance**" menu of the touch screen.
- ☞ Confirm the instruction by pressing "**Yes**", an audible signal and a message confirm the reinitialisation.

**i** The new pressure settings registered are considered to be reference values by the system.

## Screen C

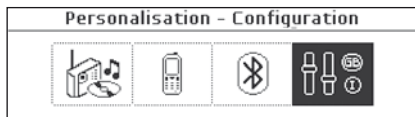

- ☞ Press the **MENU** button for access to the main menu.
- ☞ Press the "◀" or "▶" buttons to select the **Personalisation-configuration** menu, then confirm by pressing the **OK** button.



- ☞ Press the "▲" or "▼" button to select the **Define the vehicle parameters** menu, then confirm by pressing the **OK** button.
- ☞ Press the "▲" or "▼" button to select the **Driving assistance** menu, then the **Tyre pressures** menu, then the **Reinitialisation** menu, then confirming by pressing the **OK** button.  
An audible signal confirms the reinitialisation.

## Screen A Screen A (without audio system)



With the ignition on and the vehicle stationary, press this button for about 3 seconds then release it, an audible signal confirms the reinitialisation.

## Operating fault



The flashing and then fixed illumination of the under-inflation warning lamp accompanied by illumination of the Service warning lamp indicates a fault with the system. A message appears, accompanied by an audible signal.

In this case, under-inflation monitoring of the tyres is no longer assured. Have the system checked by a PEUGEOT dealer or a qualified workshop.

- Before doing anything to the system, the pressures of the four tyres must be checked and the system reinitialised.

# Fuel tank

Capacity of the tank: approximately **53** litres (or **45** litres according to version).

## Opening



- ☞ If your vehicle has Keyless Entry and Starting, unlock the vehicle.
- ☞ Press the filler flap (on the rear side of the vehicle) then pull it.

**!** If your vehicle is fitted with Stop & Start, never refuel with the engine in STOP mode; you must switch off the ignition using the key, or the START/STOP button if your vehicle has Keyless Entry and Starting.

## Refuelling

Additions of fuel must be of at least 6 litres to be registered by the fuel gauge.

Opening the filler cap may result in an inrush of air. This vacuum is entirely normal and results from the sealing of the fuel system.

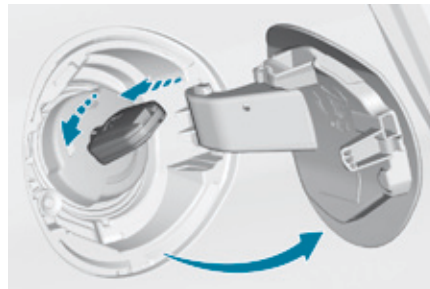

- ☞ Take care to select the pump that delivers the correct fuel type for your vehicle's engine (reminder on a label on the inside of the filler flap).
- ☞ Introduce the key into the filler cap, if your vehicle has a normal key.
- ☞ Turn the filler cap to the left.



- ☞ Remove the filler cap and hang it on its carrier (on the filler flap).
- ☞ Introduce the nozzle and push it in fully (pushing on the metal non-return valve **A**).
- ☞ Fill the tank. Do not continue past the third cut-off of the nozzle, as this may cause malfunctions.
- ☞ Refit the filler cap turning it to the right.
- ☞ Push the filler flap to close it (your vehicle must be unlocked).

# 7

Your vehicle is fitted with a catalytic converter, a device which helps to reduce the level of harmful emissions in the exhaust gases.

**For petrol engines, you must use unleaded fuel only.**

The filler neck is narrower, admitting petrol nozzles only.

**!** If you have put in the wrong fuel for your vehicle, you must have the tank drained and refilled with the correct fuel before you start the engine.

## Low fuel level



When the low fuel level in the tank is reached, this warning lamp comes on in the instrument panel, accompanied by an audible warning and a message.

When it first comes on, less than 6 litres of fuel remain in the tank.

You must refuel as soon as possible to avoid running out.

## Fuel supply cut-off

Your vehicle is equipped with a safety device which cuts off the fuel supply in the event of a collision.

## Diesel misfuel prevention

Mechanical device which prevents filling the tank of a Diesel vehicle with petrol. It avoids the risk of engine damage that can result from filling with the wrong fuel.

Located in the filler neck, the misfuel prevention device appears when the filler cap is removed.

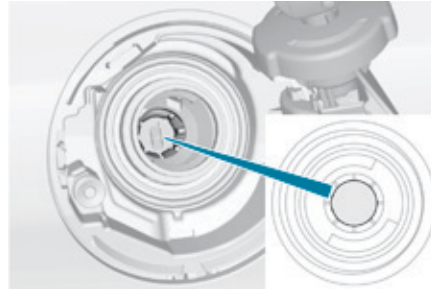

**i** It is still possible to use a fuel can to fill the tank but this must be done slowly. In order to ensure a good flow of fuel, do not place the nozzle of the fuel can in direct contact with the flap of the misfuel prevention device.

When a petrol filler nozzle is introduced into the fuel filler neck of a Diesel vehicle, it comes into contact with the flap. The system remains closed and prevents filling.

**Do not persist but introduce a Diesel filler nozzle.**

## Travelling abroad

As Diesel fuel pump nozzles may be different in other countries, the presence of the misfuel prevention device may make refuelling impossible.

Not all Diesel vehicles are fitted with misfuel protection, so before travelling abroad, we recommend that you check with the PEUGEOT dealer network, whether your vehicle is suitable for the fuel pumps in the country in which you intend to travel.



## Fuel used for petrol engines

The petrol engines are compatible with bio-fuels that conform to current and future European standards and can be obtained from filling stations:

**E5**

- Petrol that meets the EN228 standard, mixed with a bio-fuel meeting the EN15376 standard.

**E10**

**i** The only petrol additives authorised for use are those that meet the B715001 standard.

### **i** Travelling abroad

**Certain fuels could damage the engine of your vehicle. In certain countries, the use of a particular fuel may be required (specific octane rating, specific sales name...) to ensure correct operation of the engine.**

For any additional information, contact your dealer.

## Fuel used for Diesel engines

The Diesel engines are compatible with biofuels that conform to current and future European standards and can be obtained from filling stations:

**B7**

- Diesel fuel that meets standard EN590 mixed with a biofuel that meets standard EN14214 (possibly containing up to 7 % Fatty Acid Methyl Ester),

**B10**

- Diesel fuel that meets standard EN16734 mixed with a biofuel that meets standard EN14214 (possibly containing up to 10 % Fatty Acid Methyl Ester),

**XTL**

- Paraffinic Diesel fuel that meets standard EN15940 mixed with a biofuel that meets standard EN14214 (possibly containing up to 7 % Fatty Acid Methyl Ester).

**B20**

The use of B20 or B30 fuel meeting standard EN16709 is possible in your Diesel engine. However, this use, even occasional, requires strict application of the special servicing conditions referred to as "Arduous conditions".

**B30**

For more information, contact a PEUGEOT dealer or a qualified workshop.

**i** The use of any other type of (bio) fuel (vegetable or animal oils, pure or diluted, domestic fuel...) is strictly prohibited (risk of damage to the engine and fuel system).

**!** The only Diesel additives authorised for use are those that meet the B715000 standard.

## Snow chains

In wintry conditions, snow chains improve traction as well as the behaviour of the vehicle when braking.

**i** The snow chains must be fitted only to the front wheels. They must never be fitted to "space-saver" type spare wheels.

**i** Take account of the legislation in force in your country on the use of snow chains and the maximum running speed authorised.

**!** It is strongly recommended that before you leave, you practise fitting the snow chains on a level and dry surface.

Use only the chains designed to be fitted to the type of wheel fitted to your vehicle:

| Original tyre size | Type of chain   |
|--------------------|-----------------|
| 195/65 R15         | 9 mm links      |
| 205/55 R16         |                 |
| 225/45 R17         |                 |
| 225/40 R18         | K-Summit K23    |
| 235/35 R19         | Polaire Grip 70 |

You can also use snow socks.  
For more information on snow chains, contact a PEUGEOT dealer or a qualified workshop.

### Advice on installation

- ☞** If you have to fit the chains during a journey, stop the vehicle on a flat surface on the side of the road.
- ☞** Apply the parking brake and position any wheel chocks to prevent movement of your vehicle.
- ☞** Fit the chains following the instructions provided by the manufacturer.
- ☞** Move off gently and drive for a few moments, without exceeding 30 mph (50 km/h).
- ☞** Stop your vehicle and check that the snow chains are correctly tightened.

**i** Avoid driving with snow chains on roads that have been cleared of snow, to avoid damaging your vehicle's tyres and the road surface. If your vehicle is fitted with alloy wheels, check that no part of the chain or its fixings is in contact with the wheel rim.

## Very cold climate screen

Removable screen which prevents the accumulation of snow at the radiator cooling fan.

**!** Before fitting or removing the screen, ensure that the engine is off and the cooling fan has stopped. It is recommended that the screen be fitted and removed by a PEUGEOT dealer or a qualified workshop.

### Fitting



- ☞ Offer up the screen to the front of the top section of the front bumper upper grille.
- ☞ Press on the screen to engage its fixing clips.

### Removal

- ☞ Use a screwdriver as a lever to unclip each retaining clip in turn.

- !** Do not forget to remove the very cold climate screen:
- when the ambient temperature exceeds 10° C (for example: in summer, ...),
  - when towing,
  - at speeds above 75 mph (120 km/h).

## Towing a trailer



Your vehicle is primarily designed for transporting people and luggage, but it may also be used for towing a trailer.

**i** We recommend the use of genuine PEUGEOT towbars and their harnesses that have been tested and approved from the design stage of your vehicle, and that the fitting of the towbar is entrusted to a PEUGEOT dealer or a qualified workshop.

If the towbar is not fitted by a PEUGEOT dealer, it must still be fitted in accordance with the vehicle manufacturer's instructions.

### Blanking cover



When towing, you must remove the blanking cover if your vehicle has one. Contact a PEUGEOT dealer or a qualified workshop for this.

**i** The cover is located behind the lower air intake grille.

**!** Driving with a trailer places greater demands on the towing vehicle and the driver must take particular care.

**i** For more information on **Driving advice**, particularly when towing, refer to the corresponding section.

**i** For more information on **Weights** (and the towed loads which apply to your vehicle) refer to the corresponding section.

**!** You must observe the maximum trailer weight, indicated on the registration certificate or in the technical specification for your vehicle.

### **!** GTi towbar

Your vehicle cannot be fitted with a towbar.

## Energy economy mode

System which manages the duration of use of certain functions to conserve a sufficient level of charge in the battery.

After the engine has stopped, you can still use functions such as the audio and telematics system, windscreen wipers, dipped beam headlamps, courtesy lamps, etc. for a maximum combined duration of about forty minutes.

### Switching to economy mode

A message appears in the instrument panel screen indicating that the vehicle has switched to economy mode and the active functions are put on standby.

If a telephone call is being made at this time, it will be maintained for around 10 minutes with the Bluetooth hands-free system of your audio system.

### Exiting economy mode

These functions are reactivated automatically next time the vehicle is driven.

In order to restore the use of these functions immediately, start the engine and let it run:

- for less than ten minutes, to use the equipment for approximately five minutes,
- for more than ten minutes, to use the equipment for up to approximately thirty minutes.

Let the engine run for the duration specified to ensure that the battery charge is sufficient.

Do not repeatedly and continuously restart the engine in order to charge the battery.

A flat battery prevents the engine from starting.

**i** For more information on the **12 V battery**, refer to the corresponding section.

## Load reduction mode

System which manages the use of certain functions according to the level of charge remaining in the battery.

When the vehicle is being driven, the load reduction function temporarily deactivates certain functions, such as the air conditioning, the heated rear screen...

The deactivated functions are reactivated automatically as soon as conditions permit.

## Accessories

A wide range of accessories and genuine parts is available from the PEUGEOT dealer network. These accessories and parts are all suitable for your vehicle and benefit from PEUGEOT's recommendation and warranty.

### Conversion kits

You can obtain an "Enterprise" kit to convert a trade vehicle to a private car and vice-versa.

### "Comfort"

Door deflectors, side blinds and rear blind, cigarette lighter, boot dividers, coat hanger fixed to head restraint, front centre armrest, under shelf storage, front and rear parking sensors, styling mudflaps, window film, boot management system, ...

### "Transport solutions"

Boot liners, roof bars, bicycle carrier on roof bars, ski carrier, roof box, towbar harness, ...  
Tow bar, which must be fitted by PEUGEOT dealer or a qualified workshop.

### "Styling"

alloy wheels from 15 inch to 18 inch, finishers for wheels, door sills, gear lever knobs, ...  
"Ligne S": 16 and 17 inch alloy wheels, body kit, stickers, interior and exterior mirror shells, gear lever knob, door sills, mats\*, ...

### "Security and safety"

Anti-theft alarm, window engraving, wheel security bolts, child seats and booster cushions, breathalyzer, first aid kit, warning triangle, high visibility jacket, stolen vehicle tracking system, temporary puncture repair kit, snow chains, non-slip covers, front foglamps kit, dog guard, ...

### "Protection"

Mats\*, seat covers compatible with lateral airbags, mud flaps, side protection rubbing strips, bumper protection rubbing strips, bumper protectors, boot sill finishers, boot mat, ...

### "Multimedia"

Multimedia support, hands-free kit, DVD player, driving aids, vehicle tracking system, ...

- \* To avoid any risk of jamming of the pedals:
- ensure that the mat is positioned and secured correctly,
  - never fit one mat on top of another.

## **i** Installation of radio communication transmitters

Before installing any after-market radio communication transmitter, you can contact a PEUGEOT dealer for the specification of transmitters which can be fitted (frequency, maximum power, aerial position, specific installation requirements), in line with the Vehicle Electromagnetic Compatibility Directive (2004/104/EC).

By visiting a PEUGEOT dealer, you can also obtain products for cleaning and maintenance (exterior and interior) - including ecological products in the "TECHNATURE" range, topping up products (screenwash...), touch-up pens and paint aerosols for the exact colour of your vehicle, refills (cartridge for the temporary puncture repair kit...), ...

**i** Depending on the legislation in force in the country, certain safety equipment may be compulsory: high visibility safety vests, warning triangles, breathalyzers, spare bulbs, spare fuses, fire extinguisher, first aid kit, mud flaps at the rear of the vehicle.

**!** The fitting of electrical equipment or accessories which are not recommended by PEUGEOT may result in a failure of your vehicle's electronic system and excessive electrical consumption. Contact a PEUGEOT dealer for information on the range of recommended equipment and accessories.

## Changing a wiper blade

### Before removing a front wiper blade



- ☞ Within one minute after switching off the ignition, operate the wiper stalk to position the wiper blades vertically on the windscreen.

### Removing

- ☞ Raise the corresponding wiper arm.
- ☞ Unclip the wiper blade and remove it.

### Fitting

- ☞ Put the corresponding new wiper blade in place and clip it.
- ☞ Fold down the wiper arm carefully.

### After fitting a front wiper blade

- ☞ Switch on the ignition.
- ☞ Operate the wiper stalk again to park the wiper blades.

## Bicycle / accessory carrier



- i** Do not fit an accessory carrier to the tailgate.



## Fitting roof bars

When fitting roof bars, you must only secure them to the four anchorage points on the sides of the roof. These points are hidden by the vehicle's doors when they are closed.

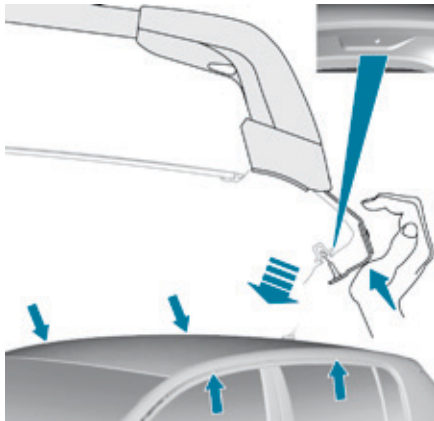

**!** Use accessories approved by PEUGEOT observing the manufacturer's recommendations and fitting instructions so as to avoid the risk of damaging the body (deformation, scratches, ...).

**i** Do not exceed the maximum authorised load, shown in the instructions for the roof bars.

If the height exceeds 40 cm, adapt the speed of the vehicle to the profile of the road to avoid damaging the roof bars and the fixings on the roof.

Be sure to refer to national legislation in order to comply with the regulations for transporting objects which are longer than the vehicle.

### Fitting on longitudinal bars

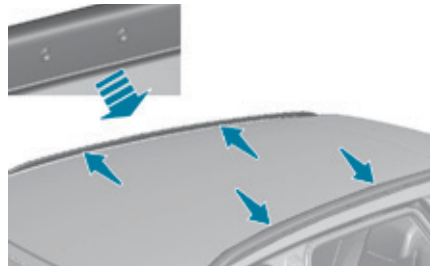

You must attach the transverse bars at the engraved markings on the longitudinal bars.

As a safety measure and to avoid damaging the roof, it is essential to use the transverse bars approved for your vehicle.

Observe the instructions on fitting and use contained in the guide supplied with the roof bars.

### Recommendations

- Distribute the load evenly, avoiding overloading on one side.
- Arrange the heaviest part of the load as close as possible to the roof.
- Lash the load securely.
- Drive gently: the vehicle will be more susceptible to the effects of side winds and the stability of the vehicle may be affected.
- On a long journey, check the security of the load at every stop.
- Remove the roof bars once they are no longer needed.



# PEUGEOT & TOTAL, A PARTNERSHIP TO DELIVER BETTER PERFORMANCE!

2015 was marked by PEUGEOT's return to Rally-Raid, one of the most difficult motorsport disciplines in the world. To obtain the best performance in these trials, PEUGEOT Sport chose TOTAL QUARTZ for the PEUGEOT 2008 DKR, a lubricant of high technology which protects the engine in the most severe conditions.

## **TOTAL QUARTZ protects your engine against the effects of time.**

TOTAL QUARTZ Ineo First is a high performance lubricant, the result of work done together by PEUGEOT and TOTAL R&D. Specially formulated for the engines in PEUGEOT vehicles, its innovative technology significantly reduces CO<sub>2</sub> emissions and keeps your engine clean.

PEUGEOT RECOMMENDS TOTAL



# Bonnet

- !** Before doing anything under the bonnet, deactivate the Stop & Start system to avoid any risk of injury resulting from an automatic change to START mode.



## Opening

- ☞ Open the door.



- ☞ Pull the release lever, located at the bottom of the door aperture, towards you.



- ☞ Pull the safety catch towards you, then raise the bonnet.

- !** Do not open the bonnet under very windy conditions. When the engine is hot, handle the exterior safety catch and the stay with care (risk of burns). To avoid damaging electrical units, it is strictly **forbidden** to use a high pressure jet wash under the bonnet.



- ☞ Unclip the stay from its housing and place it in the support slot to hold the bonnet open.

## Closing

- ☞ Take the stay out of its support slot.
- ☞ Clip the stay back into its housing.
- ☞ Lower the bonnet and release it at the end of its travel.
- ☞ Pull on the bonnet to check that it has latched correctly.

## Petrol engine

1. Screenwash and headlamp wash reservoir.
2. Coolant header tank.
3. Brake fluid filler cap.
4. Battery / Fuses.
5. Fusebox.
6. Air filter.
7. Engine oil dipstick.
8. Engine oil filler cap.
9. Remote earth point.

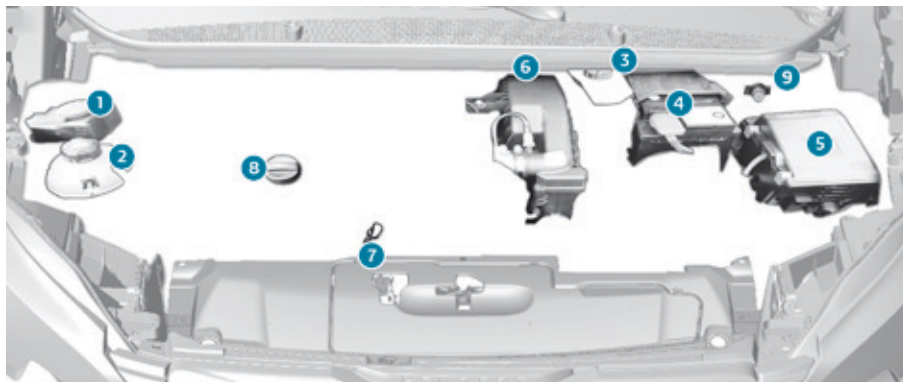

This engine is shown as an example. The locations of the engine oil dipstick and filler cap may vary.

# Diesel engine

1. Screenwash and headlamp wash reservoir.
2. Coolant header tank.
3. Brake fluid filler cap.
4. Battery / Fuses.
5. Fusebox.
6. Air filter.
7. Engine oil dipstick.
8. Engine oil filler cap.
9. Priming pump\*.
10. Remote earth point.

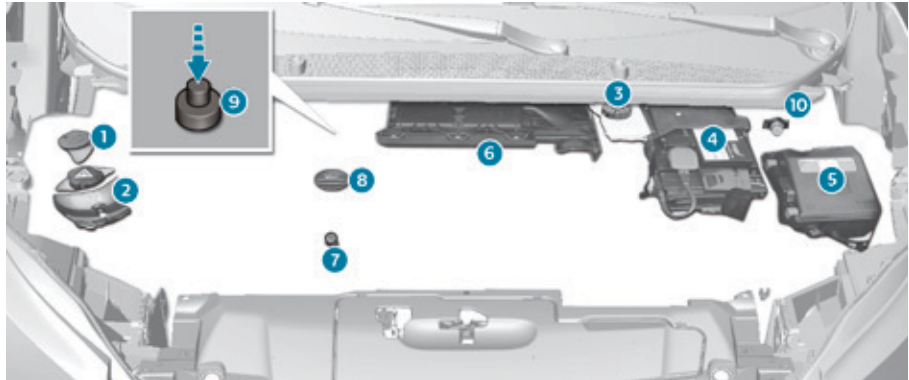

This engine is shown as an example. The locations of the engine oil dipstick and filler cap may vary.

\* According to engine.

## Checking levels

Check all of these levels regularly, in line with the manufacturer's service schedule. Top them up if necessary, unless otherwise indicated. If a level drops significantly, have the corresponding system checked by a PEUGEOT dealer or a qualified workshop.

**!** Take care when working under the bonnet, as certain areas of the engine may be extremely hot (risk of burns) and the cooling fan could start at any time (even with the ignition off).

### Engine oil level



The check is carried out either when the ignition is switched on using the oil level indicator in the instrument panel for vehicles so equipped, or using the dipstick.

To ensure that the reading is correct, your vehicle must be parked on a level surface with the engine having been off for more than 30 minutes.

It is normal to top-up the oil level between two services (or oil changes). PEUGEOT recommends that you check the level, and top-up if necessary, every 3 000 miles (5 000 kms).

### Checking using the dipstick

The location of the dipstick is shown in the corresponding underbonnet layout view.

- ☞ Take the dipstick by its coloured grip and remove it completely.
- ☞ Wipe the end of the dipstick using a clean non-fluffy cloth.
- ☞ Refit the dipstick and push fully down, then pull it out again to make the visual check: the correct level is between the marks **A** and **B**.

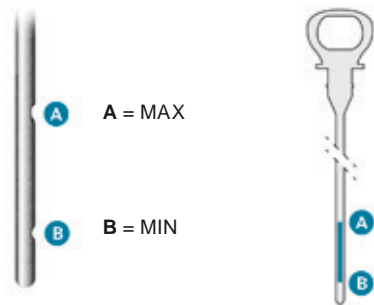

If you find that the level is above the **A** mark or below the **B** mark, **do not start the engine**.

- If the level is above the **MAX** mark (risk of damage to the engine), contact a PEUGEOT dealer or a qualified workshop.
- If the level is below the **MIN** mark, you must top-up the engine oil.

## Oil grade

Before topping-up the oil or changing the oil, check that the oil is the correct grade for your engine and conforms to the manufacturer's recommendations.

## Topping-up the engine oil level

The location of the oil filler cap is shown in the corresponding underbonnet layout view.

- ☞ Unscrew the oil filler cap to reveal the filler aperture.
- ☞ Add oil in small quantities, avoiding any spills on engine components (risk of fire).
- ☞ Wait a few minutes before checking the level again using the dipstick.
- ☞ Add more oil if necessary.
- ☞ After checking the level, carefully refit the oil filler cap and the dipstick in its tube.

**i** After topping-up the oil, the check when switching on the ignition with the oil level indicator in the instrument panel is not valid during the 30 minutes after topping-up.

## Engine oil change

Refer to the manufacturer's service schedule for details of the interval for this operation. In order to maintain the reliability of the engine and emission control system, never use additives in the engine oil.

## Brake fluid level

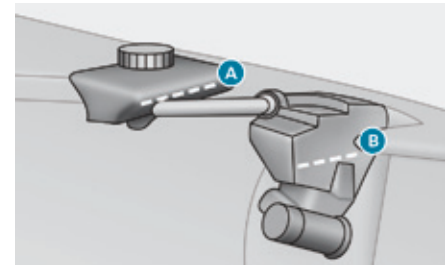

The brake fluid level must be between the marking "A" (MAX located on the remote reservoir) and the marking "B" (MIN located on the main reservoir). If it is not, check the brake pad wear.

## Changing the fluid

Refer to the personalised service schedule for your vehicle for details of the interval for this operation.

## Fluid specification

The brake fluid must conform to the manufacturer's recommendations.

## Coolant level



The coolant level should be close to the "MAX" mark but should never exceed it.

When the engine is warm, the temperature of the coolant is regulated by the fan.

**The cooling fan may start after switching off the engine: take care with articles and clothing that might be caught by the fan blades.**

In addition, as the cooling system is pressurised, wait at least one hour after switching off the engine before carrying out any work.

To avoid any risk of scalding, unscrew the cap by two turns to allow the pressure to drop. When the pressure has dropped, remove the cap and top-up the level.

**i** It is normal to top-up the coolant level between services (or coolant replacements).

## Fluid specification

The coolant must conform to the manufacturer's recommendations.

## Screenwash and headlamp wash fluid



In the case of vehicles fitted with headlamp washers, the low fluid level is indicated by an audible signal and a message in the instrument panel screen.

Top-up the reservoir when you next stop the vehicle.

## Fluid specification

For optimum cleaning and to avoid freezing, this fluid must not be topped-up with or replaced with plain water.

In wintry conditions, the use of an ethyl alcohol or methanol base fluid is recommended.

## Diesel additive level (Diesel engine with particle filter)

**SERVICE** A low additive level is indicated by illumination of this warning lamp, accompanied by an audible warning and a message in the instrument panel screen.

## Topping-up

This additive must be topped-up by a PEUGEOT dealer or a qualified workshop without delay.

## Used products

**!** Avoid prolonged contact of used oil or fluids with the skin. Most of these fluids are harmful to health or indeed very corrosive.

**♻️** Do not discard used oil or fluids into sewers or onto the ground. Take used oil to a PEUGEOT dealer or a qualified workshop (France) or to an authorised waste disposal site.



# Checks

Unless otherwise indicated, check these components in accordance with the manufacturer's service schedule and according to your engine. Otherwise, have them checked by a PEUGEOT dealer or a qualified workshop.

## 12 V battery



The battery does not require any maintenance. However, check regularly that the terminals are correctly tightened (versions without quick release terminals) and that the connections are clean.

For more information and the precautions to take before starting work on the **12 V battery**, refer to the corresponding section.

**!** Versions equipped with Stop & Start are fitted with a 12 V lead-acid battery of specific technology and specification. Its replacement should be carried out only by a PEUGEOT dealer or a qualified workshop.

## Air filter and passenger compartment filter



Refer to the manufacturer's service schedule for details of the replacement intervals for these components.

Depending on the environment (e.g. dusty atmosphere) and the use of the vehicle (e.g. city driving), **replace them twice as often if necessary**.

A clogged passenger compartment filter may have an adverse effect on the performance of the air conditioning system and generate undesirable odours.

## Oil filter



Replace the oil filter each time the engine oil is changed. Refer to the manufacturer's service schedule for details of the replacement interval for this component.

## Particle filter (Diesel)

**SERVICE** The start of saturation of the particle filter is indicated by the temporary illumination of this warning lamp accompanied by a message in the multifunction screen.

**i** As soon as the traffic conditions permit, regenerate the filter by driving at a speed of at least 40 mph (60 km/h) until the warning lamp goes off. If the warning lamp stays on, this indicates a low additive level. For more information on **Checking levels**, refer to the corresponding section.

On a new vehicle, the first particle filter regeneration operations may be accompanied by a "burning" smell, which is perfectly normal. Following prolonged operation of the vehicle at very low speed or at idle, you may, in exceptional circumstances, notice the emission of water vapour at the exhaust on acceleration. This does not affect the behaviour of the vehicle or the environment.

## Manual gearbox



The gearbox does not require any maintenance (no oil change). Refer to the manufacturer's service schedule for the checking interval for this component.

## Automatic gearbox



The gearbox does not require any maintenance (no oil change). Refer to the manufacturer's service schedule for the checking interval for this component.

## Parking brake



If excessive travel or a loss of effectiveness of this system is noticed, the parking brake must be checked, even between two services.

Checking this system must be done by a PEUGEOT dealer or a qualified workshop.

## Brake pads



Brake wear depends on the style of driving, particularly in the case of vehicles used in town, over short distances. It may be necessary to have the condition of the brakes checked, even between vehicle services.

Unless there is a leak in the circuit, a drop in the brake fluid level indicates that the brake pads are worn.

## Brake disc wear



For information on checking brake disc wear, contact a PEUGEOT dealer or a qualified workshop.

## Electric parking brake



This system does not require any routine servicing. However, in the event of a problem, have the system checked by a PEUGEOT dealer or a qualified workshop.

**i** For more information on the **Electric parking brake**, refer to the corresponding section.

**!** Only use products recommended by PEUGEOT or products of equivalent quality and specification. In order to optimise the operation of units as important as those in the braking system, PEUGEOT selects and offers very specific products. After washing the vehicle, dampness, or in wintry conditions, ice can form on the brake discs and pads: braking efficiency may be reduced. Make light brake applications to dry and defrost the brakes.

# AdBlue® and SCR system for BlueHDi Diesel engines

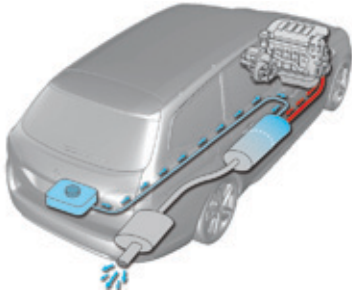

To assure respect for the environment and conformity with the new Euro 6 emissions standard, without adversely affecting the performance or fuel consumption of Diesel engines, PEUGEOT has taken the decision to equip its vehicles with an effective system that associates SCR (Selective Catalytic Reduction) with a particle filter (FAP) for the treatment of exhaust gases.

## SCR system

Using a fluid called AdBlue® containing urea, a catalytic converter turns up to 85% of nitrogen oxides (NOx) into nitrogen and water, which are harmless to health and the environment.

The AdBlue® is held in a special tank with a capacity of about 17 litres: this provides a driving range of about 12 500 miles (20 000 km). An alert is triggered automatically to warn you when the reserve level is reached: you can then drive about 1 500 miles (2 400 km) before the tank is empty.

During each scheduled service of your vehicle by a PEUGEOT dealer or a qualified workshop, the AdBlue® tank is refilled in order to allow normal operation of the SCR system.

If the estimated mileage of your vehicle between two services is greater than 12 500 miles (20 000 km), it will be necessary to top-up the AdBlue®.

**!** Once the AdBlue® tank is empty, a system required by regulations prevents starting of the engine. If the SCR system is faulty, the level of emissions from your vehicle will no longer meet the Euro 6 standard: your vehicle becomes polluting. In the event of a confirmed fault with the SCR system, you must go to a PEUGEOT dealer or a qualified workshop as soon as possible: after a running distance of 650 miles (1 100 km), a system will be triggered automatically to prevent engine starting. In either case, a range indicator gives you the distance you can travel before the vehicle is immobilised.

## Topping-up the AdBlue®

Filling the AdBlue® tank is an operation included in every routine service on your vehicle by a PEUGEOT dealer or a qualified workshop.

Nevertheless, given the capacity of the tank, it may be necessary to top-up the fluid between services, more particularly if an alert (warning lamps and a message) signals the requirement. You can go to a PEUGEOT dealer or a qualified workshop.

If you envisage topping-up yourself, please read the following warnings carefully.

### ! Important

If your vehicle's AdBlue® tank is completely empty (which is confirmed by the alert messages and the impossibility of starting the engine) you must add at least 3.8 litres (so two 1.89 litre bottles).

## Precautions in use

AdBlue® is a urea-based solution. This liquid is non-flammable, colourless and odourless (kept in a cool area).

In the event of contact with the skin, wash the affected area with soap and water. In the event of contact with the eyes, wash (irrigate) the eyes with large amounts of water or with an eye wash solution for at least 15 minutes.

If a burning sensation or irritation persists, get medical attention.

If swallowed, immediately wash out the mouth with clean water and then drink plenty of water. In certain conditions (high ambient temperature, for example), the risk of release of ammonia cannot be excluded: do not inhale the fluid. Ammonia vapour has an irritant effect on mucous membranes (eyes, nose and throat).

- ! Keep AdBlue® out of the reach of children, in its original container or bottle.  
Never transfer AdBlue® to another container: it would lose its purity.

Use only AdBlue® fluid that meets the ISO 22241 standard.

- ! Never dilute AdBlue® with water.  
Never pour AdBlue® into the Diesel fuel tank.



# AdBlue®

The supply in a non-drip container or bottle simplifies topping-up. You can obtain 1.89 litre (half a US gallon) bottles or 5 litre containers from a PEUGEOT dealer or a qualified workshop.

- ! Never top-up from an AdBlue® dispenser reserved for heavy goods vehicles.

## Recommendations on storage

AdBlue® freezes at about -11°C and deteriorates above 25°C. It is recommended that bottles be stored in a cool area and protected from direct sunlight.

Under these conditions, the fluid can be kept for at least a year.

If the additive has frozen, it can be used once it has completely thawed out.

**!** Never store bottles of AdBlue® in your vehicle.

**♻️** Do not dispose of AdBlue® bottles or containers in the household waste. Place them in a container provided for this purpose or take them to your dealer.

### **i** Freezing of the AdBlue®

AdBlue® freezes at temperatures below around -11°C.

The SCR system includes a heater for the AdBlue® tank, allowing you to continue driving in very cold conditions.

## Procedure

Before starting the top-up procedure, ensure that the vehicle is parked on a flat and level surface.

- ☞ Switch off the ignition and remove the key, or if your vehicle has one, press the START/STOP button to switch off the engine.

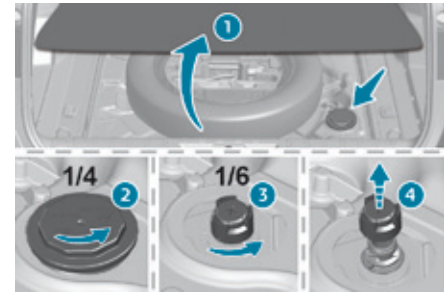

- ☞ For access to the AdBlue® tank, raise the boot carpet then, depending on equipment, lift out the spare wheel and/or the storage box.
- ☞ Without pressing, turn the black cap a quarter turn anti-clockwise and lift it off.
- ☞ Turn the blue cap a 6<sup>th</sup> of a turn anti-clockwise.
- ☞ Lift off the cap.



- ☞ Obtain a bottle of AdBlue®. After first checking the use-by date, read carefully the instructions on use on the label before pouring the contents of the bottle into your vehicle's AdBlue® tank.
- ☞ After emptying the bottle, wipe away any spillage around the tank filler using a damp cloth.

- ! If any AdBlue® fluid is spilt or splashed, wash immediately with cold water or wipe with a damp cloth. If the AdBlue® has crystallised, clean it off using a sponge and hot water.
- ☞ Refit the blue cap to the tank and turn it a 6<sup>th</sup> of a turn clockwise, to its stop.
- ☞ Refit the black cap and turn it a quarter of a turn clockwise without pressing. Ensure that the indicator on the cap lines up with the indicator on the support.
- ☞ Depending on equipment, return the spare wheel and/or the storage box to the bottom of the boot.
- ☞ Refit the boot carpet and close the tailgate.

- ! Important: **when topping-up after running out of AdBlue®**, signalled by the message "Top-up AdBlue: Starting prevented", you must wait for about 5 minutes before switching the ignition on again, **without opening the driver's door, unlocking the vehicle, introducing the remote control key into the ignition switch, or placing the electronic key of the "Keyless Entry and Starting" system inside the vehicle.** Switch on the ignition, then wait for 10 seconds before starting the engine.



Never dispose of AdBlue® bottles in the household waste. Place them in a special container provided for this purpose or take them to your dealer.

## Version with bass woofer unit

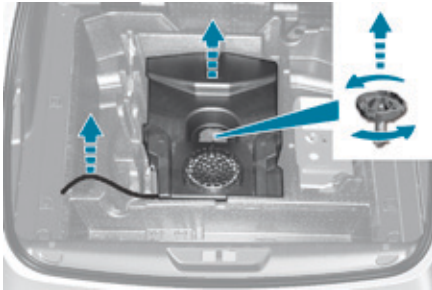

- Carefully disengage the wiring harness from its housing to give a little more free length.
- Remove the yellow screw retaining the woofer unit.

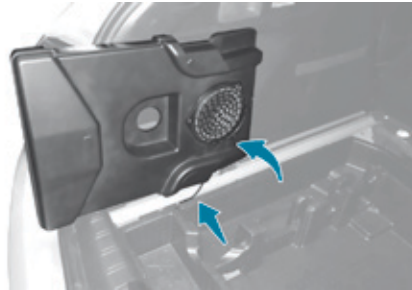

- ☞ Place the bass woofer unit to the side of the boot.

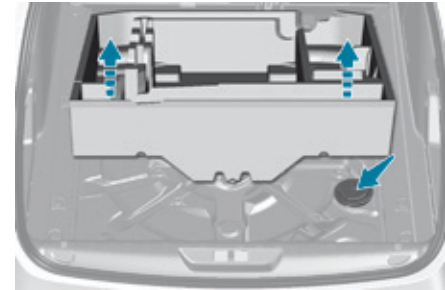

- ☞ Remove or raise the storage well.

For reassembly, first slacken the yellow screw a few turns.

## Warning triangle (stowing)

This safety equipment should be used in addition to the hazard warning lamps.

Its presence in the vehicle may be mandatory, depending on country.

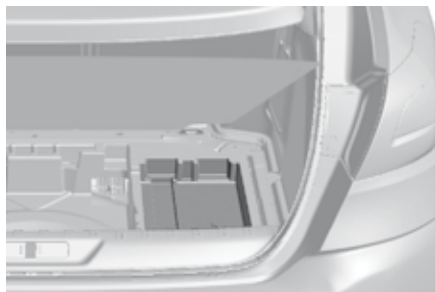

The storage location for a folded triangle or its box is under the boot floor.

**!** Before leaving your vehicle to set up and install the triangle, switch on the hazard warning lamps and put on your high visibility vest.

### Placing the triangle in the road

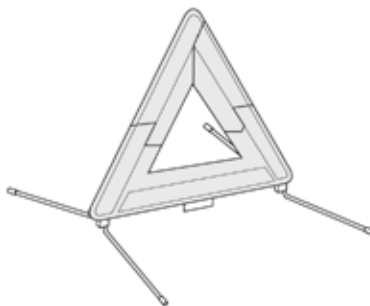

- ☞ Place the triangle behind the vehicle, as required by the legislation in force in your country.

Refer to the manufacturer's instructions on unfolding and installing supplied with the triangle.

**i** The triangle is available as an accessory; contact a PEUGEOT dealer or a qualified workshop.



# Temporary puncture repair kit

This kit consists of a compressor and a sealant cartridge.

It allows the **temporary repair** of a tyre.

You are then able to go to the nearest garage. It is designed to repair most punctures which could affect the tyre, located on the tyre tread or shoulder.

Its compressor can be used to check and adjust the pressure of the tyre.

## Access to the kit



This kit is installed in the storage box, under the boot floor.

## List of tools

These tools are specific to your vehicle and can vary according to equipment. Do not use them for other purposes.

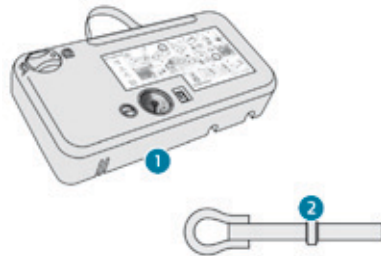

1. 12 V compressor.  
To temporarily repair a tyre using an integral sealant cartridge and adjust the tyre pressure.
2. Towing eye.

**i** For more information on **Towing**, refer to the corresponding section.



The tyre inflation pressures are given on this label.

**!** The 12 V socket at the rear of the vehicle allows the connection of the compressor for long enough to repair or inflate a tyre.

## Description of the kit

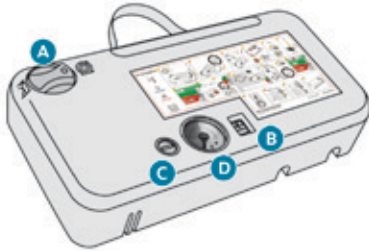

- A. "Sealant" or "Air" position selector.
- B. On "I" / off "O" switch.
- C. Deflation button.
- D. Pressure gauge (in bars and psi).

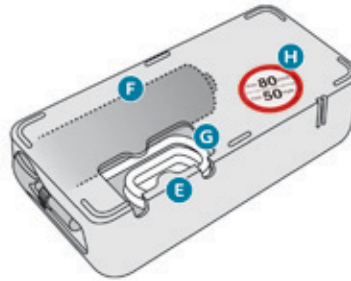

- E. Compartment housing a cable with an adaptor for a 12 V socket.
- F. Sealant cartridge.
- G. White pipe with cap for repair and inflation.
- H. Speed limit sticker.

**i** The speed limit sticker **H** must be affixed to the vehicle's steering wheel to remind you that a wheel is in temporary use.  
Do not exceed a speed of 50 mph (80 km/h) when driving with a tyre repaired using this type of kit.

## Repair procedure

### 1. Sealing

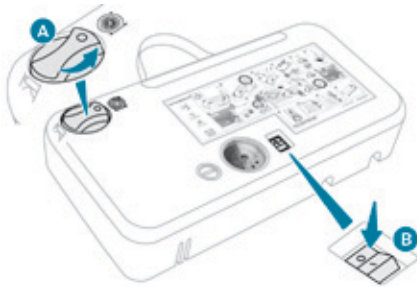

☞ Switch off the ignition.



☞ Turn the selector **A** to the "sealant" position.

☞ Check that the switch **B** is in position "O".

**i** Avoid removing any foreign bodies which have penetrated into the tyre.



☞ Uncoil the white pipe **G** fully.

☞ Unscrew the cap from the white pipe.

☞ Connect the white pipe to the valve of the tyre to be repaired.

**!** Take care, this product is harmful if swallowed and causes irritation to the eyes. Keep this product out of the reach of children.

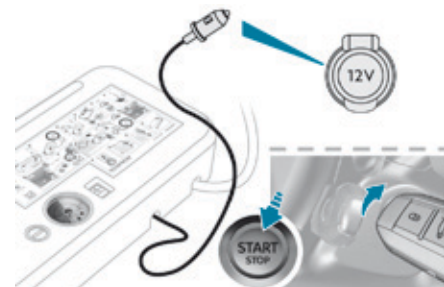

☞ Connect the compressor's electric plug to the vehicle's 12 V socket.

☞ Start the vehicle and leave the engine running.

**!** Do not start the compressor before connecting the white pipe to the tyre valve: the sealant product would be expelled through the pipe.

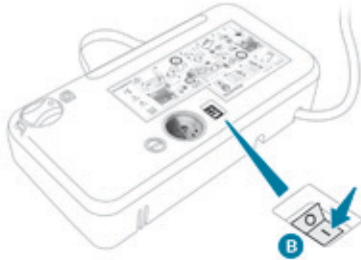

- ☞ Switch on the compressor by moving the switch **B** to position "I" until the tyre pressure reaches 2.0 bars. The sealant is injected into the tyre under pressure; do not disconnect the pipe from the valve during this operation (risk of splashing).

**i** If after around 5 to 7 minutes the pressure is not attained, this indicates that the tyre is not repairable; contact a PEUGEOT dealer or a qualified workshop for assistance.

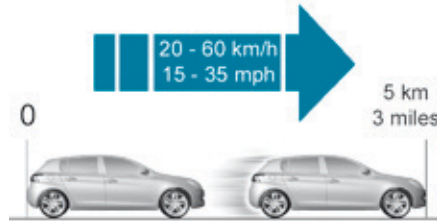

- ☞ Remove the kit and screw the cap back on the white pipe. Take care to avoid staining your vehicle with traces of fluid. Keep the kit to hand.
- ☞ Drive immediately for approximately three miles (five kilometres), at reduced speed (between 12 and 37 mph (20 and 60 km/h)), to plug the puncture.
- ☞ Stop to check the repair and the tyre pressure using the kit.

## 2. Inflation

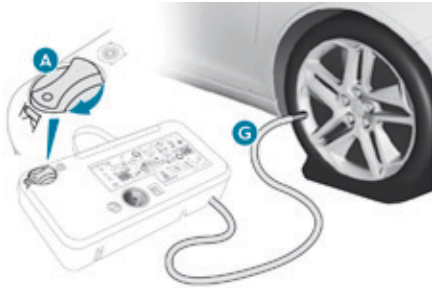

☞ Turn the selector **A** to the "Air" position.

- ☞ Uncoil the white pipe **G** fully.
- ☞ Connect the white pipe to the tyre valve.



- ☞ Connect the compressor's electric plug to the vehicle's 12 V socket.
- ☞ Start the vehicle again and leave the engine running.



As soon as possible, go to a PEUGEOT dealer or a qualified workshop. You must inform the technician that you have used this kit. After inspection, the technician will advise you on whether the tyre can be repaired or if it must be replaced.

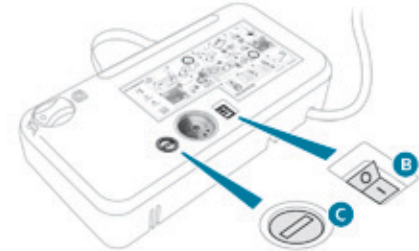

- ☞ Adjust the pressure using the compressor (to inflate: switch **B** in position "I"; to deflate: switch **B** in position "O" and press button **C**), in accordance with the vehicle's tyre pressure label (located on the left-hand door aperture).
- A loss of pressure indicates that the puncture has not been fully plugged; contact a PEUGEOT dealer or qualified workshop for assistance.
- ☞ Remove and stow the kit.
- ☞ Drive at reduced speed (50 mph [80 km/h] max) limiting the distance travelled to approximately 120 miles (200 km).

## Removing the pipe and cartridge

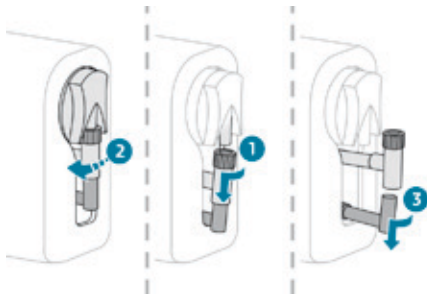

- ☞ Turn the pipe assembly **2** to the left until it contacts the unit.
- ☞ Disconnect the union **1** from the cartridge by turning it a quarter turn anti-clockwise.
- ☞ Extract the pipe assembly **2**, then disconnect the union **3** from the air delivery pipe by turning it a quarter turn anti-clockwise.

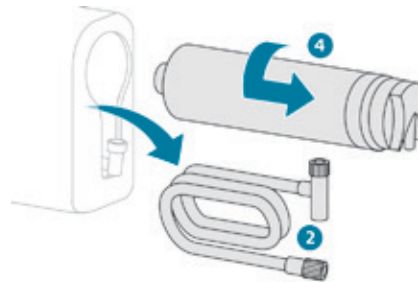

- ☞ Remove the pipe assembly **2**.
  - ☞ Support the compressor vertically.
  - ☞ Unscrew the cartridge **4** from the bottom.
- To fit the new cartridge and new pipe, carry out these operations in reverse order.

**!** Beware of discharges of fluid.  
The expiry date of the fluid is indicated on the cartridge.  
The sealant cartridge is designed for single use; even if only partly used, it must be replaced.  
After use, do not discard the cartridge into the environment, take it to an authorised waste disposal site or a PEUGEOT dealer.  
Do not forget to obtain a new sealant cartridge, available from PEUGEOT dealers or from a qualified workshop.

## Checking / adjusting tyre pressures



You can also use the compressor without injecting any product, to check and if necessary adjust your tyre pressures.



- ☞ Turn the selector **A** to the "Air" position.

- ☞ Uncoil the white pipe **G** fully.
- ☞ Connect the pipe to the tyre valve.

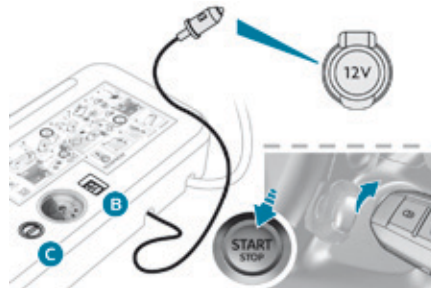

- ☞ Connect the compressor's electrical connector to the vehicle's 12 V socket.
- ☞ Start the vehicle and let the engine run.
- ☞ Adjust the pressure using the compressor (to inflate: switch **B** in position "I"; to deflate: switch **B** in position "O" and press button **C**), according to the vehicle's tyre pressure label.
- ☞ Remove the kit then stow it.

**!** Should the pressure of one or more tyres be adjusted, it is necessary to reinitialise the under-inflation detection system. For more information on **Under-inflation detection**, refer to the corresponding section.

## Spare wheel

Procedure for changing a wheel with a damaged or punctured tyre for the spare wheel using the tools provided with the vehicle.

### Access to the tooling



The tools are installed in the boot under the floor.

- i** The jack must only be used to change a wheel with a damaged tyre. The jack does not require any maintenance. The jack conforms to European legislation, such as defined in the Machinery Directive 2006/42/CE.

### List of tools

These tools are specific to your vehicle and can vary according to the level of equipment. Do not use them for other purposes.

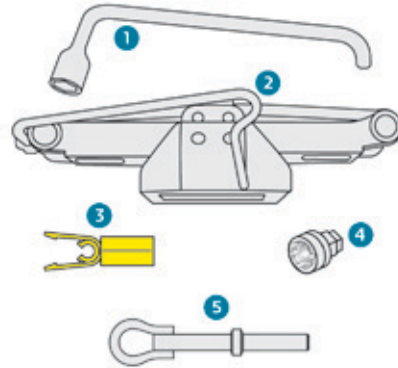

1. Wheelbrace.  
For removing the wheel trim and removing the wheel bolts.
2. Jack with integral handle.  
For raising the vehicle.

3. Wheel bolt cover removal tool.  
For removing the bolt head protectors on alloy wheels.
4. Socket for the security bolts (located in the glove box).  
For adapting the wheelbrace to the special "security" bolts.
5. Towing eye.

**i** For more information on **Towing**, refer to the corresponding section.

### **i** Wheel with trim

**When refitting the wheel**, refit the trim starting by placing its notch facing the valve and press around its edge with the palm of your hand.



## Access to the spare wheel



The spare wheel is located in the boot under the floor.

Depending on the country of sale, the spare wheel may be steel, alloy or of the "space-saver" type.

## Taking out the wheel

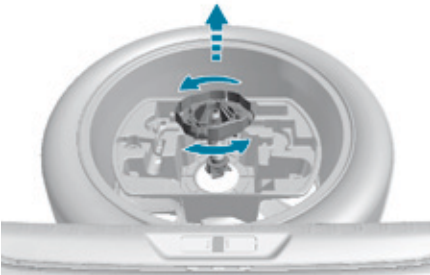

- ☞ Unscrew the (coloured) central nut.
- ☞ Remove the fixing parts (nut and bolt).
- ☞ Raise the spare wheel towards you from the rear.
- ☞ Take the wheel out of the boot.

## Putting the wheel back in place

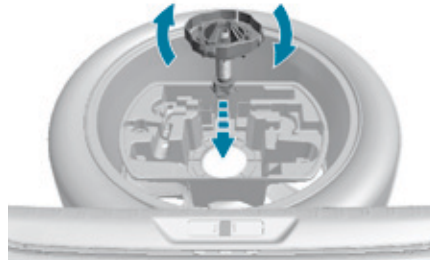

- ☞ Put the wheel back in its housing.
- ☞ Unscrew the (coloured) central nut by a few turns on the bolt.
- ☞ Put the fixing parts (nut and bolt) in place in the middle of the wheel.
- ☞ Tighten fully until the central nut clicks to retain the wheel correctly.

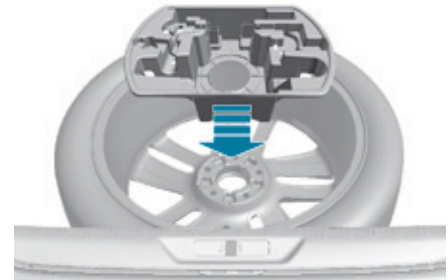

- ☞ Put the box back in place in the centre of the wheel and clip it.
- ☞ Put the polystyrene storage box back in place.

## Removing a wheel

### **i** Parking the vehicle

Immobilise the vehicle where it does not block traffic: the ground must be level, stable and not slippery. With a manual parking brake, apply the parking brake and check that the brake warning lamp is on.

With an electric parking brake, if not programmed in automatic mode, apply the parking brake and check that the brake warning lamp and the **P** indicator lamp in the parking brake control lever are on.

Switch off the ignition. With a manual gearbox, engage first gear to block the wheels.

With an automatic gearbox, place the selector at position **P** to block the wheels. The occupants must get out of the vehicle and wait where they are safe. Never go underneath a vehicle raised using a jack; use an axle stand.

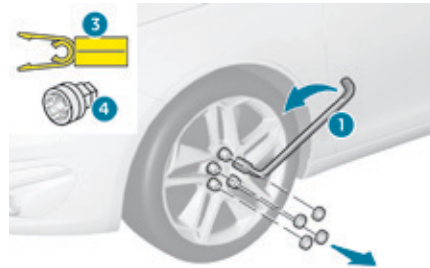

- ☞ Remove the bolt cover(s) using the tool **3** (according to equipment).
- ☞ Fit the security socket **4** on the wheelbrace **1** to slacken the security bolt (if fitted).
- ☞ Slacken the other bolts using the wheelbrace **1** only.



- ☞ Position the foot of the jack on the ground, ensuring that it is directly below the vehicle's jacking point **A** or **B**, the one closest to the wheel to be changed.

- !** Do not use:
- the jack for any other purpose than lifting the vehicle,
  - a jack other than the one supplied by the manufacturer.

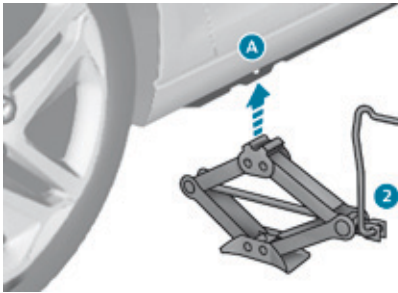

- ☞ Extend the jack **2** until its head comes into contact with the jacking point **A** or **B** used, with the contact surface **A** or **B** on the vehicle correctly engaged with the central part of the head of the jack.

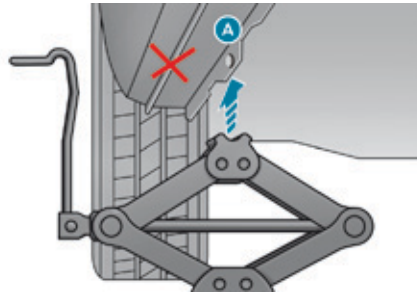

- ☞ Raise the vehicle until there is sufficient space between the wheel and the ground to admit the spare (not punctured) wheel easily.



- ☞ Remove the bolts and store them in a clean place.
- ☞ Remove the wheel.

**!** Ensure that the jack is stable. If the ground is slippery or loose, the jack may slip or drop - Risk of injury!  
 Ensure that the jack is positioned only at one of the jacking points **A** or **B** under the vehicle, making sure that the vehicle's contact surface is centred on the head of the jack. Otherwise there is a risk of damage to the vehicle and/or of the jack dropping - Risk of injury!

## Fitting a wheel



### **i** Fitting the "space-saver" spare wheel

If your vehicle is fitted with alloy wheels, when tightening the bolts on fitting, it is normal to notice that the washers do not come into contact with the "space-saver" spare wheel. The wheel is secured by the conical surface of each bolt.

- ⌘ Put the wheel in place on the hub.
- ⌘ Screw in the bolts fully by hand.
- ⌘ Pre-tighten the security bolt using the wheelbrace 1 fitted with the security socket 4 (according to equipment).
- ⌘ Pre-tighten the other bolts using the wheelbrace 1 only.

- ⌘ Lower the vehicle fully.
- ⌘ Fold the jack 2 and detach it.

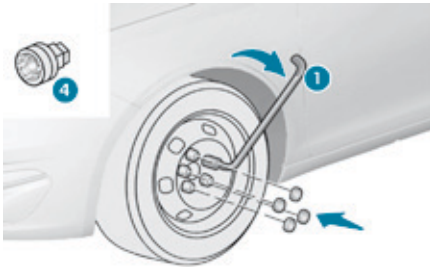

- ☞ Tighten the security bolt using the wheelbrace **1** fitted with the security socket **4** (according to equipment).
- ☞ Tighten the other bolts using the wheelbrace **1** only.
- ☞ Refit the bolt cover(s) (according to version).
- ☞ Store the tools in the box.

### **i** After changing a wheel

To store the punctured wheel in the boot correctly, first remove the central cover. When using the "space-saver" type spare wheel, do not exceed 50 mph (80 km/h).

Have the tightening of the bolts and the pressure of the spare wheel checked by a PEUGEOT dealer or a qualified workshop without delay.

Have the punctured wheel repaired and refitted to the vehicle as soon as possible.

If your vehicle has tyre under-inflation detection, check the tyre pressures then reinitialise the system.

For more information on **Under-inflation detection**, refer to the corresponding section.



The tyre inflation pressures are given on this label.

# Changing a bulb

## Front lamps

### Model with halogen headlamps



1. Dipped beam headlamps (H7-55W).
2. Main beam headlamps (HB3).
3. Direction indicators (PY21-21W).
4. Daytime running lamps / sidelamps (light emitting diodes - LEDs).

For H7 type bulbs with lugs... take care to observe their correct installation so as to ensure the best lighting performance.

### Model with "full LED" technology headlamps



1. Daytime running lamps / sidelamps (light emitting diodes - LEDs).
2. Dipped beam headlamps (light emitting diodes - full LEDs).
3. Main beam headlamps (light emitting diodes - full LEDs).
4. Direction indicators (PY21-21W).

### Front fog lamps (H11)



### Direction indicators (GT version)

For the replacement of this type of LED lamp, contact a PEUGEOT dealer or a qualified workshop.

A replacement kit for the LEDs is available from PEUGEOT dealers.

- !** The headlamps have polycarbonate lenses with a protective coating:
- ☞ **do not clean them using a dry or abrasive cloth, nor with a detergent or solvent product,**
  - ☞ use a sponge and soapy water or a pH neutral product,
  - ☞ when using a high pressure washer on persistent marks, do not keep the lance directed towards the lamps or their edges for too long, so as not to damage their protective coating and seals.

Changing a bulb should only be done after the headlamp has been switched off for several minutes (risk of serious burns).

- ☞ Do not touch the bulb directly with your fingers, use a lint-free cloth.

It is imperative to use only anti-ultraviolet (UV) type bulbs to avoid damaging the headlamp.

Always replace a failed bulb with a new bulb with the same type and specification.

- i** In some weather conditions (e.g. low temperature or humidity), the presence of misting on the internal surface of the glass of the headlamps and rear lamps is normal; it disappears after the lamps have been on for a few minutes.

## Daytime running lamps / sidelamps

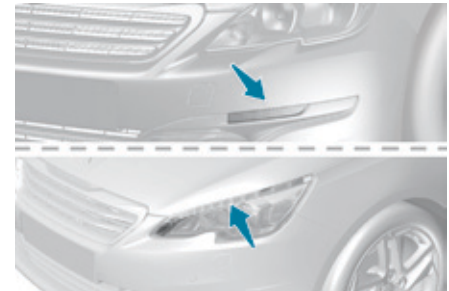

For the replacement of this type of LED lamp and lighting guides, contact a PEUGEOT dealer or a qualified workshop.

A replacement kit for the LEDs is available from PEUGEOT dealers.

## Tips for removing the headlamp (halogen model)

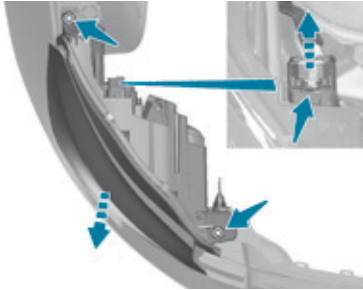

To allow the headlamp to be moved forward a few centimetres for access to the bulbs, proceed as follows:

- ☞ Move the orange clip towards the rear then while pressing on the black part (located above the orange clip) pull on the connector.
- ☞ Remove the two screws holding the lamp.
- ☞ Disengage the rear pin then the front centre piece.
- ☞ Move the lamp forwards.

### Dipped beam headlamps (halogen model)

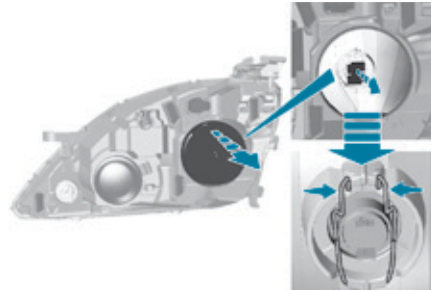

- ☞ Remove the protective plastic cover by pulling on the tab.
  - ☞ Disconnect the bulb connector.
  - ☞ Disengage the two springs (press then move them outwards).
  - ☞ Extract the bulb by pulling and change it.
- For reassembly, carry out these operations in reverse order.

### Main beam headlamps (halogen model)

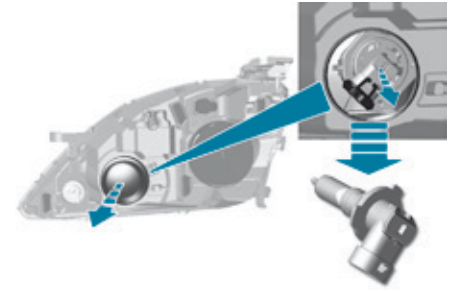

- ☞ Remove the protective plastic cover by pulling on the tab.
  - ☞ Turn the connector (with its bulb) towards the top (1/4 turn).
  - ☞ Remove the bulb by pulling it out and change it.
- For reassembly, carry out these operations in reverse order.

**!** Be aware that the area behind the right-hand headlamp (facing forwards) may be hot, with the risk of burns (overflow pipe).



## Direction indicators (halogen model)

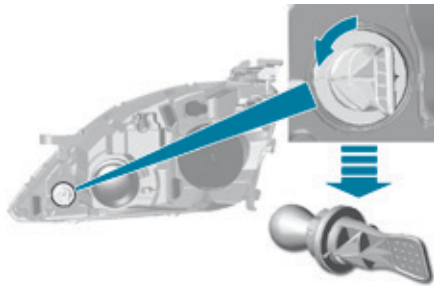

- ☞ Unscrew the bulb holder (1/4 turn).
- ☞ Remove the bulb holder.
- ☞ Change the failed bulb.

For reassembly, carry out these operations in reverse order.

- i** Faster flashing of a direction indicator warning lamp (left or right) indicates a failed bulb on that side.

## Daytime running lamps / sidelamps ("full LED" technology model)



For the replacement of this type of "full LED" light emitting diode lamps, contact a PEUGEOT dealer or a qualified workshop.

## Direction indicators ("full LED" technology model)

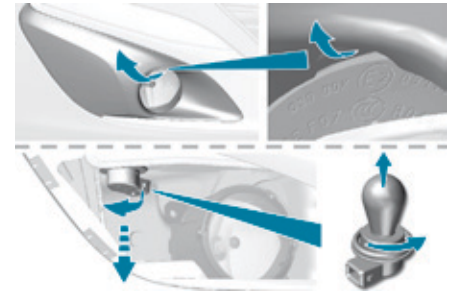

- i** Faster flashing of a direction indicator warning lamp (left or right) indicates a failed bulb on that side.

The direction indicator bulb is located below the front lamp.

- ☞ Unclip the finisher by pulling at the top (cut-out).
- ☞ Unscrew the bulb holder (1/4 turn).
- ☞ Change the failed bulb.

For reassembly, carry out these operations in reverse order.

## Front foglamps

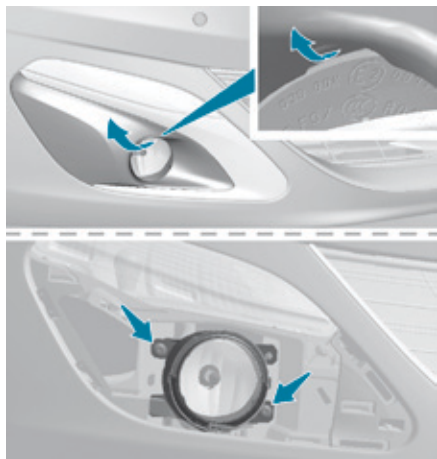

- ☞ Unclip the finisher by pulling at the top (cut-out).
- ☞ Remove the two screws to remove the unit from its housing.

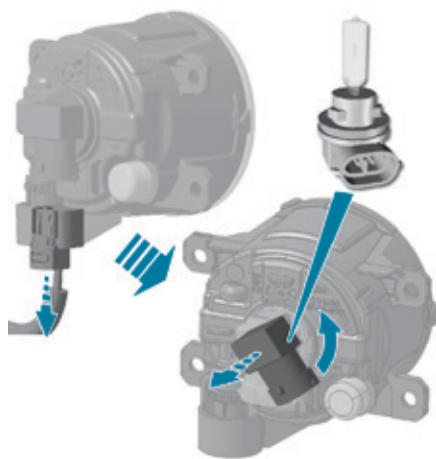

- ☞ Disconnect the connector.
- ☞ Unscrew the bulb holder (1/4 turn).
- ☞ Remove the bulb holder.
- ☞ Change the failed bulb.

For reassembly, carry out these operations in reverse order, pressing on the finisher to refit it.

## Door mirror spotlamps



You should contact a PEUGEOT dealer or a qualified workshop for the replacement of the light-emitting diode - LED.

## Integrated direction indicator side repeaters

You should contact a PEUGEOT dealer or a qualified workshop for the replacement of these bulbs.

## Rear lamps (hatchback)

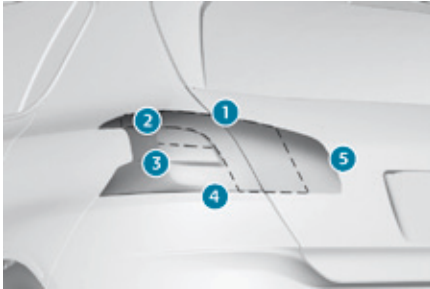

1. Sidelamps (light-emitting diodes - LEDs).
2. Reversing lamps (W16W).
3. Direction indicators (PY21W amber).
4. Brake lamps (light-emitting diodes - LEDs).
5. Foglamps (P21W).

### **i** Light-emitting diodes - LEDs

For replacement, contact a PEUGEOT dealer or qualified workshop.

## Reversing lamps, direction indicators (on the wings)



- ☞ Open the tailgate then remove the access cover.

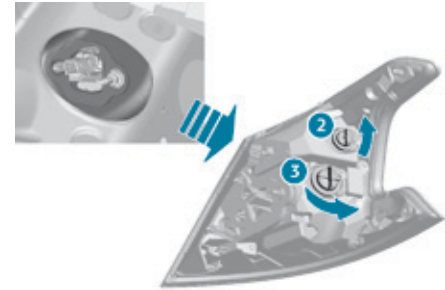

- ☞ Disconnect the lamp connector.
  - ☞ Remove the lamp fixing nut.
  - ☞ Carefully remove the lamp unit from outside.
  - ☞ Unscrew the bulb holder (a quarter of a turn) and change the bulb.
- For reassembly, carry out these operations in reverse order.

## Foglamp (tailgate)



- ☞ Open the tailgate and then remove the large plastic cover.



- ☞ Unclip the left and right access covers.
- ☞ Remove the screws located in each opening.
- ☞ Unclip the boot trim for access to the lamp connector.
- ☞ Disconnect the lamp connector.
- ☞ Remove the lamp fixing nut.
- ☞ Carefully remove the lamp from the outside.
- ☞ Unscrew the bulb holder (a quarter of a turn) and change the bulb.

For reassembly, carry out these operations in reverse order.

## Rear lamps (SW)

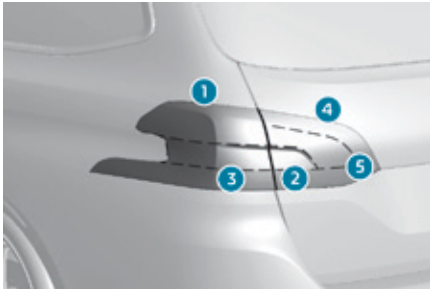

1. Sidelamps (light-emitting diodes - LEDs).
2. Direction indicators (PY21W amber).
3. Brake lamps (light-emitting diodes - LEDs).
4. Reversing lamps (W16W).
5. Foglamps (P21W).

### **i** Light-emitting diodes - LEDs

For replacement, contact a PEUGEOT dealer or qualified workshop.

## Direction indicators (on the wings)

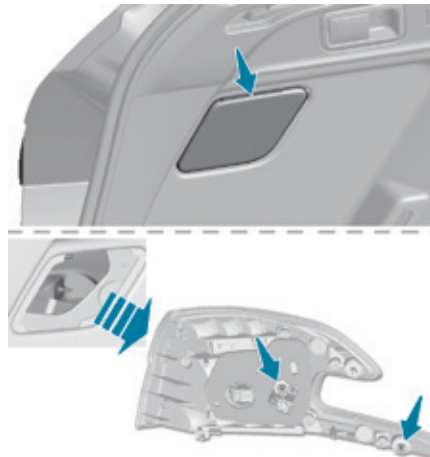

- ☞ Open the tailgate then remove the access cover.
- ☞ Remove the two lamp fixing nut (pipe spanner or socket recommended).
- ☞ Disengage the retaining clip, carefully removing the lamp unit from outside.

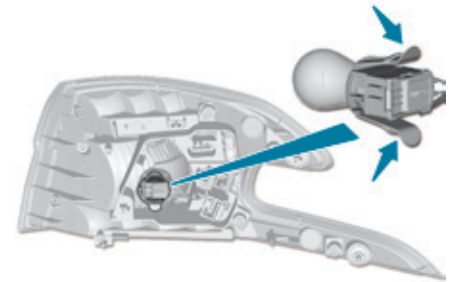

- ☞ Disconnect the lamp connector.
- ☞ Remove the sealing foam.
- ☞ Unclip the bulb holder by pressing on the two tongues.
- ☞ Replace the bulb.

For reassembly, carry out these operations in reverse order.

## Reversing lamp, rear foglamp (tailgate)



- ☞ Open the tailgate and then remove the access cover.
- ☞ Remove the lamp fixing nut.

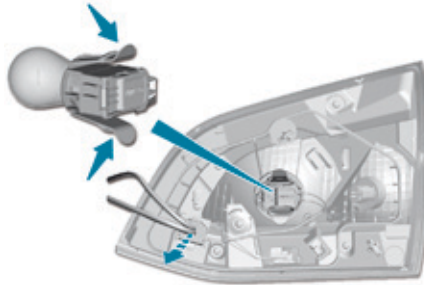

- ☞ Carefully remove the lamp from the outside.
- ☞ Disconnect the lamp connector.
- ☞ Foglamp: unclip the bulb holder by pressing on the two tongues then replace the bulb.
- ☞ Reversing lamp: turn the bulb holder a quarter of a turn then replace the bulb.

For reassembly, carry out these operations in reverse order.

### Third brake lamp (light-emitting diodes-LED)



For the replacement of this type of lamp, contact a PEUGEOT dealer or a qualified workshop.

### Number plate lamps (W5W)

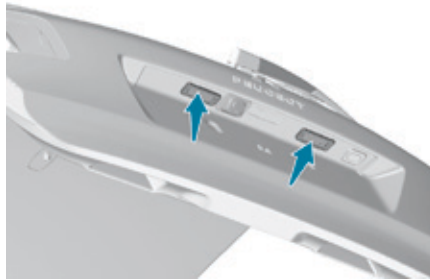

- ☞ Insert a thin screwdriver into one of the cut-outs in the lens.
- ☞ Push it outwards to unclip it.
- ☞ Remove the lens.
- ☞ Change the faulty bulb.

To refit, press on the lens to clip it in place.

## Changing a fuse

### Access to the tools

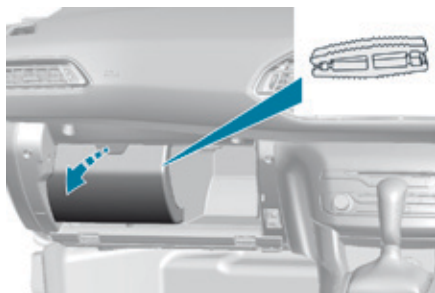

The extraction tweezer is fitted to the back of the dashboard fusebox cover.

- ☞ Unclip the cover by pulling at the top left, then right.
- ☞ Disengage the cover completely and turn it over.
- ☞ Remove the tweezer from the back of the cover to which it is fitted.

### Changing a fuse

Before changing a fuse:

- ☞ the cause of the failure must be identified and rectified,
- ☞ all electrical consumers must be switched off,
- ☞ the vehicle must be immobilised with the ignition off,
- ☞ identify the failed fuse using the tables and layout drawings in the following pages.

To replace a fuse, you must:

- ☞ use the special tweezer to extract the fuse from its housing and check the condition of its filament,
- ☞ always replace the failed fuse with a fuse of the same rating (same colour); using a different rating could cause faults (risk of fire).

If the fuse fails again soon after replacement, have the vehicle's electrical system checked by a PEUGEOT dealer or a qualified workshop.

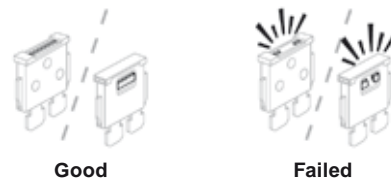

Good

Failed



Tweezer

**!** The replacement of a fuse not shown in the tables below may cause a serious malfunction of your vehicle. Contact a PEUGEOT dealer or a qualified workshop.



### **i** Installing electrical accessories

Your vehicle's electrical system is designed to operate with standard or optional equipment.

Before installing other electrical equipment or accessories on your vehicle, contact a PEUGEOT dealer or a qualified workshop.

**!** PEUGEOT will not accept responsibility for the cost incurred in repairing your vehicle or for rectifying malfunctions resulting from the installation of accessories not supplied and not recommended by PEUGEOT and not installed in accordance with its instructions, in particular when the combined consumption of all of the additional equipment connected exceeds 10 milliamperes.

## Dashboard fuses

The fusebox is placed in the lower dashboard (left-hand side).

### Access to the fuses



☞ Unclip the cover by pulling at top left, then right.

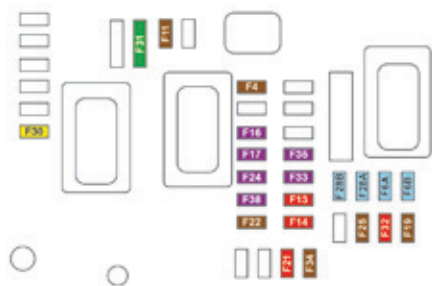

### Version 1 (Full)

| Fuse N°    | Rating (A) | Functions  |
|------------|------------|--|
| F4         | 5          | Emergency and assistance calls.                    |
| F6 A or B  | 15         | Audio system, touch screen, CD player, navigation. |
| F11        | 5          | "Keyless Entry and starting" system                |
| F13        | 10         | Front 12 V accessory socket.                       |
| F14        | 10         | 12 V accessory socket in the boot.                 |
| F16        | 3          | Glove box lamp, rear courtesy lamp.                |
| F17        | 3          | Vanity mirror lamp, front courtesy lamp.           |
| F19        | 5          | Instrument panel.                                  |
| F21        | 10         | Multifunction screen, air conditioning.            |
| F22        | 5          | Reversing camera, parking sensors.                 |
| F24        | 3          | Rain and sunshine sensor                           |
| F25        | 5          | Airbags.   |
| F28 A or B | 15         | Audio system (battery +).                          |
| F30        | 20         | Rear wiper.  |
| F31        | 30         | Locks.   |
| F32        | 10         | Hi-Fi amplifier.                                   |
| F33        | 3          | Memorisation of driving positions.                 |
| F34        | 5          | Electric power steering.                           |
| F35        | 3          | Seat belts not fastened display.                   |

## Version 2 (Eco)

| Fuse N° | Rating (A) | Functions   |
|---------|------------|---|
| F9      | 5          | Emergency and assistance calls.                               |
| F13     | 5          | Reversing camera and parking sensors                          |
| F15     | 15         | 12 V accessory socket.  |
| F16     | 15         | Cigarette lighter.  |
| F17     | 15         | Audio system.   |
| F18     | 20         | Touch screen, CD player, audio and navigation system.         |
| F19     | 5          | Rain, sunshine sensor.  |
| F20     | 5          | Airbags.  |
| F21     | 5          | Instrument panel.   |
| F22/F24 | 30         | Interior, exterior, front and rear locks.                     |
| F23     | 5          | Glove box lamp, vanity mirror, front and rear courtesy lamps. |
| F25/F27 | 15         | Front/rear screenwash pump.                                   |
| F26     | 15         | Horn.   |
| F30     | 15         | Rear wiper.   |

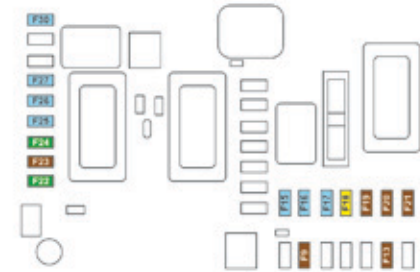

## Engine compartment fuses

The fusebox is located in the engine compartment near the battery.

### Access to the fuses

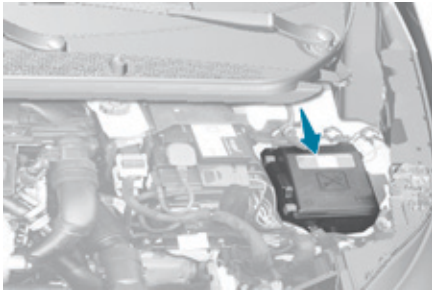

- ☞ Unclip the cover.
- ☞ Change the fuse.
- ☞ When you have finished, close the cover carefully to ensure correct sealing of the fusebox.

## Version 1 (Full)

### Fusebox 1

| Fuse N° | Rating (A) | Functions                         |
|---------|------------|-----------------------------------|
| F12     | 5          | Park Assist control unit.         |
| F14     | 25         | Front and rear screenwash pump    |
| F15     | 5          | Power steering.                   |
| F19     | 30         | Front wiper motor.                |
| F20     | 15         | Front and rear screenwash motors. |
| F21     | 20         | Headlamp wash.                    |
| F22     | 15         | Horn.                             |
| F23     | 15         | Right-hand main beam headlamp.    |
| F24     | 15         | Left-hand main beam headlamp.     |



**Fusebox 2**

| Fuse N° | Rating (A) | Functions                                  |
|---------|------------|--|
| F8      | 30         | Diesel emissions control system (AdBlue®). |
| F10     | 5          | Automatic gearbox.                         |
| F12     | 15         | Automatic gearbox.                         |

**Version 2 (Eco)**

| Fuse N° | Rating (A) | Functions   |
|---------|------------|---|
| F13     | 5          | Built-in systems interface.   |
| F16     | 15         | Front foglamps.   |
| F18     | 10         | Right-hand main beam headlamp.  |
| F19     | 10         | Left-hand main beam headlamp.   |
| F25     | 40         | Headlamp wash relay (aftermarket fitment).  |
| F27     | 25         | Built-in systems interface.   |
| F28     | 30         | Diesel emissions control system (AdBlue®).  |
| F29     | 30         | Front wiper motor.  |
| F30     | 80         | Pre-heater plugs (Diesel), additional programmable heating (aftermarket fitment), headlamp wash pump. |



## 12 V battery

Procedure for starting the engine using another battery or charging a discharged battery.

### General points

#### Lead-acid starter batteries



Batteries contain harmful substances such as sulphuric acid and lead. They must be disposed of in accordance with regulations and must not, in any circumstances, be discarded with household waste. Take used remote control batteries and vehicle batteries to a special collection point.



Versions equipped with Stop & Start are fitted with a 12 V lead-acid battery of specific technology and specification. Its replacement should be carried out only by a PEUGEOT dealer or a qualified workshop.



Protect your eyes and face before handling the battery. All operations on the battery must be carried out in a well ventilated area and away from naked flames and sources of sparks, so as to avoid the risk of explosion or fire. Wash your hands afterwards.



If your vehicle has an automatic gearbox, do not try to start the engine by pushing the vehicle.



#### Before doing any work

Immobilise the vehicle: apply the parking brake, put the gearbox in neutral, then switch off the ignition. Check that all electrical equipment is switched off.

### Access to the battery

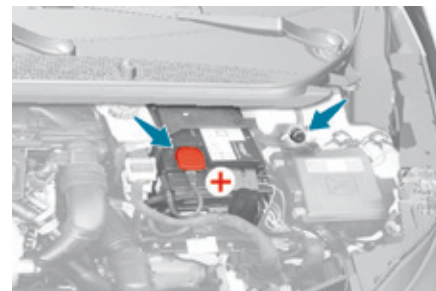

The battery is located under the bonnet.

To gain access to it:

- ☞ Open the bonnet using the interior release lever, then the exterior safety catch.
- ☞ Secure the bonnet stay.
- ☞ Remove the plastic cover to access the (+) terminal.

The (-) terminal of the battery is not accessible. A remote earth point is located on the engine.

## Starting using another battery

When your vehicle's battery is discharged, the engine can be started using a slave battery (external or on another vehicle) and jump lead cables or a battery booster.

**!** Never try to start the engine by connecting a battery charger. Never use a 24 V or higher battery booster.

First check that the slave battery has a nominal voltage of 12 V and a capacity at least equal to that of the discharged battery.

The two vehicles must not be in contact with each other.

Switch off the electrical consumers on both vehicles (audio system, wipers, lighting, ...).

Ensure that the jump lead cables do not pass close to moving parts of the engine (cooling fan, belts, ...).

Do not disconnect the (+) terminal when the engine is running.

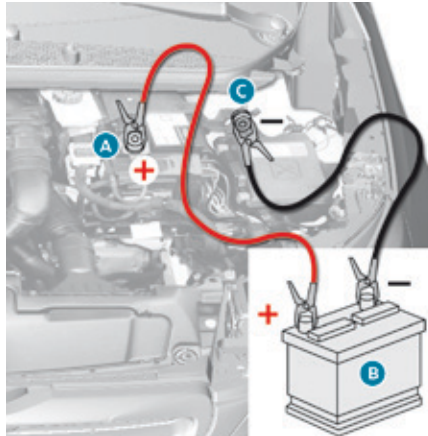

- ☞ Raise the plastic cover on the (+) terminal, if your vehicle has one.
- ☞ Connect the red cable to the positive terminal (+) of the flat battery **A** (at the metal elbow) then to the positive terminal (+) of the slave battery **B** or the booster.
- ☞ Connect one end of the green or black cable to the negative terminal (-) of the slave battery **B** or the booster (or earth point on the other vehicle).

- ☞ Connect the other end of the green or black cable to the earth point **C** on the broken down vehicle.
- ☞ Start the engine of the vehicle with the good battery and leave it running for a few minutes.
- ☞ Operate the starter on the broken down vehicle and let the engine run. If the engine does not start straight away, switch off the ignition and wait a few moments before trying again.
- ☞ Wait until the engine returns to idle then disconnect the jump lead cables in the reverse order.
- ☞ Refit the plastic cover to the (+) terminal, if your vehicle has one.
- ☞ Allow the engine to run for at least 30 minutes, by driving or with the vehicle stationary, so that the battery reaches an adequate state of charge.

**i** Some functions, including Stop & Start, are not available if the battery is not sufficiently charged.

## Charging the battery using a battery charger

For optimum service life of the battery, it is essential to maintain an adequate state of charge.

In some circumstances it may be necessary to charge the battery:

- if you use your vehicle essentially for short journeys,
- if the vehicle is to be taken off the road for several weeks.

Contact a PEUGEOT dealer or a qualified workshop.

**!** If you envisage charging your vehicle's battery yourself, use only a charger compatible with lead-acid batteries of a nominal voltage of 12 V.

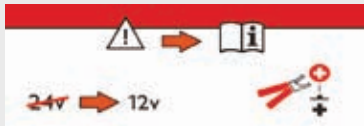

If this label is present, it is essential to use only a 12 V charger, to avoid causing irreversible damage to the electrical components related to the Stop & Start system.

**!** Follow the instructions for use provided by the manufacturer of the charger. Never reverse polarities.

**i** It is not necessary to disconnect the battery.

- ☞ Switch off the ignition.
- ☞ Switch off all electrical consumers (audio system, lighting, wipers, ...).
- ☞ Switch off the charger **B** before connecting the cables to the battery, so as to avoid any dangerous sparks.
- ☞ Ensure that the charger cables are in good condition.
- ☞ Raise the plastic cover, if your vehicle has one, on the (+) terminal.
- ☞ Connect the charger **B** cables as follows:
  - the positive (+) red cable to the (+) terminal of the battery **A**,
  - the negative (-) black cable to the earth point **C** on the vehicle.
- ☞ At the end of the charging operation, switch off the charger **B** before disconnecting the cables from the battery **A**.

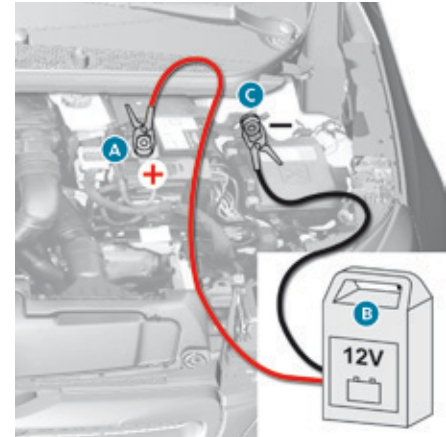

**!** Never try to charge a frozen battery. If the battery has been frozen, have it checked by a PEUGEOT dealer or a qualified workshop, who will check that the internal components have not been damaged and the casing is not cracked, which could cause a leak of toxic and corrosive acid.



## Disconnecting the battery

In order to maintain an adequate state of charge for starting the engine, it is recommended that the battery be disconnected if the vehicle is taken out of service for a long period.

Before disconnecting the battery:

- ☞ close all openings (doors, boot, windows, roof),
- ☞ switch off all electrical consumers (audio system, wipers, lighting, ...),
- ☞ switch off the ignition and wait for four minutes.

At the battery, detach just the (+) terminal.

### Quick-release terminal

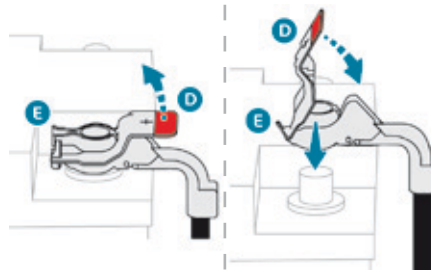

### Disconnecting the (+) cable

- ☞ Raise the lever **D** fully to release the cable terminal clamp **E**.

### Reconnecting the (+) cable

- ☞ Position the open clamp **E** of the cable on the positive post (+) of the battery.
- ☞ Press vertically on the clamp **E** to position it correctly on the battery.
- ☞ Lock the clamp by spreading the positioning lug and then lowering the lever **D**.

### Following reconnection of the battery

Following reconnection of the battery, switch on the ignition and wait 1 minute before starting to permit initialisation of the electronic systems. However, if problems remain following this operation, contact a PEUGEOT dealer or a qualified workshop.

Referring to the corresponding section, you must yourself reinitialise (depending on version):

- the remote control key,
- the electric blind(s),
- ...

**i** The Stop & Start system may not be operational during the trip following the first engine start.

In this case, the system will only be available again after a continuous period of immobilisation of the vehicle, a period which depends on the ambient temperature and the state of charge of the battery (up to about 8 hours).

**!** Do not apply excessive force on the lever as locking will not be possible if the clamp is not positioned correctly; start the procedure again.

# Towing

Procedure for having your vehicle towed or for towing another vehicle using a removable towing eye.

## Access to the tooling

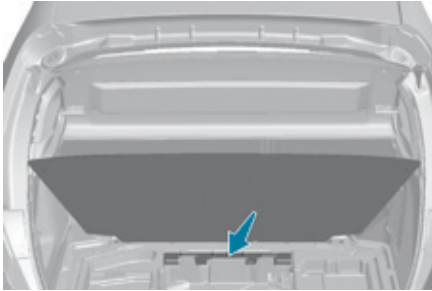

The towing eye is installed in the boot under the floor.

To gain access to it:

- ☞ open the boot,
- ☞ raise the floor,
- ☞ remove the towing eye from the holder.

## Towing your vehicle



- ☞ On the front bumper, press the cover (as shown above) to unclip it.
- ☞ Screw the towing eye in fully.
- ☞ Install the towing arm.
- ☞ Switch on the hazard warning lamps on the towed vehicle.
- ☞ Move off gently and drive slowly over a short distance only.

**i** Put the gear lever into neutral. The failure to follow this requirement may lead to damage to components of the braking system and the lack of braking assistance on restarting the engine.

## Towing another vehicle

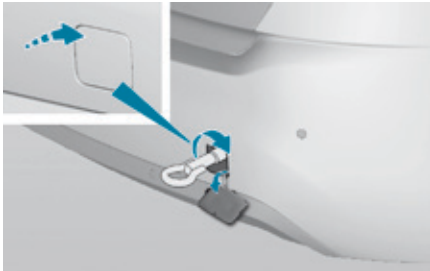

- ☞ On the rear bumper, press the cover (as shown above) to unclip it.
- ☞ Screw the towing eye in fully.
- ☞ Install the towing arm.
- ☞ Switch on the hazard warning lamps on the towed vehicle.
- ☞ Move off gently and drive slowly over a short distance only.

## ! General recommendations

Observe the legislation in force in your country.

Ensure that the weight of the towing vehicle is higher than that of the towed vehicle.

The driver must remain at the wheel of the towed vehicle and must have a valid driving licence.

When towing a vehicle with all four wheels on the ground, always use an approved towing arm; rope and straps are prohibited.

The towing vehicle must move off gently.

When towing a vehicle with the engine off, there is no longer any power assistance for braking or steering.

In the following cases, you must always call on a professional recovery service:

- vehicle broken down on a motorway or fast road,
- four-wheel drive vehicle,
- when it is not possible to put the gearbox into neutral, unlock the steering, or release the parking brake,
- towing with only two wheels on the ground,
- where there is no approved towing arm available...

**i** For more information on the **Electric parking brake** and in particular, parking the vehicle with the brake released, refer to the corresponding section.

# Running out of fuel (Diesel)

On vehicles fitted with Diesel engines, the fuel system must be primed if you run out of fuel. For all versions other than BlueHDi, refer to the corresponding engine compartment view.

**i** For more information on **Diesel misfuel prevention**, refer to the corresponding section.

**!** If the engine does not start first time, don't keep trying but start the procedure again from the beginning.

## 1.6 HDi engine



### (except BlueHDi)

- ☞ Add at least 5 litres of Diesel to the fuel tank.
- ☞ Open the bonnet.
- ☞ If necessary, unclip the styling cover for access to the priming pump.
- ☞ Squeeze and release the priming pump repeatedly until resistance is felt (there may be resistance at the first press).
- ☞ Operate the starter to start the engine (if the engine does not start at the first attempt, wait around 15 seconds before trying again).
- ☞ If the engine does not start after a few attempts, operate the priming pump again then start the engine.
- ☞ Refit the styling cover and clip it in place.
- ☞ Close the bonnet.

## BlueHDi engine

- ☞ Add at least 5 litres of Diesel to the fuel tank.
- ☞ Switch on the ignition (without starting the engine).
- ☞ Wait around 6 seconds and switch off the ignition.
- ☞ Repeat the operation 10 times.
- ☞ Operate the starter to run the engine.

## Petrol engines and gearboxes

| Engine  | 1.2 litre PureTech 82 | 1.2 litre PureTech 110 |    | 1.2 litre PureTech 130 S&S |    |                          |    |
|---|-----------------------|------------------------|----|----------------------------|----|--------------------------|----|
| Gearbox   | Manual (5-speed)      | Manual (5-speed)       |    | Manual (6-speed)           |    | EAT6 automatic (6-speed) |    |
| Model code  | LPHMZ                 | LPHNZ - LRHNZ          |    | LPHNY - LRHNY              |    | LPHNY - LRHNY            |    |
| Body style  | Hatchback             | Hatchback              | SW | Hatchback                  | SW | Hatchback                | SW |
| Cubic capacity (cc)                               | 1 199                 | 1 199                  |    | 1 199                      |    |                          |    |
| Bore x stroke (mm)                                | 75 x 90.5             | 75 x 90.5              |    | 75 x 90.5                  |    |                          |    |
| Max power: EU standard (kW)*                      | 60                    | 81                     |    | 96                         |    |                          |    |
| Max power engine speed (rpm)                      | 5 750                 | 5 500                  |    | 5 500                      |    |                          |    |
| Max torque: EU standard (Nm)                      | 118                   | 205                    |    | 230                        |    |                          |    |
| Max torque engine speed (rpm)                     | 2 750                 | 1 500                  |    | 1 750                      |    |                          |    |
| Fuel  | Unleaded              | Unleaded               |    | Unleaded                   |    |                          |    |
| Catalytic converter                               | yes                   | yes                    |    | yes                        |    |                          |    |
| <b>Oil capacity (in litres)</b>                   |                       |                        |    |                            |    |                          |    |
| Engine (with replacement of the filter cartridge) | 3.25                  | 3.5                    |    | 3.5                        |    |                          |    |

\* The maximum power corresponds to the type approved value on a test bed, under conditions defined by European legislation (directive 1999/99/EC).

| Engine  | 1.6 litre VTi 115 |    | 1.6 litre THP 135** / 150*** / 165***         |    |
|---|-------------------|----|---|----|
| Gearbox   | Manual (5-speed)  |    | EAT6 automatic (6-speed)                      |    |
| Model code  | LWNFP - LXNFP     |    | L35GL / L35GX / L35GY - L45GL / L45GX / L45GY |    |
| Body style  | Hatchback         | SW | Hatchback                                     | SW |
| Cubic capacity (cc)                               | 1 587             |    | 1 598   |    |
| Bore x stroke (mm)                                | 78.5 x 82         |    | 77 x 85.8                                     |    |
| Max power: EU standard (kW)*                      | 85 / 115          |    | 99.3 / 110 / 121.4                            |    |
| Max power engine speed (rpm)                      | 6 050             |    | 6 000   |    |
| Max torque: EU standard (Nm)                      | 150               |    | 221 / 240 / 240                               |    |
| Max torque engine speed (rpm)                     | 4 000             |    | 1 400   |    |
| Fuel  | Unleaded          |    | Unleaded                                      |    |
| Catalytic converter                               | yes               |    | yes   |    |
| <b>Oil capacity (in litres)</b>                   |                   |    |   |    |
| Engine (with replacement of the filter cartridge) | 3.5               |    | 4.25  |    |

\* The maximum power corresponds to the type approved value on a test bed, under conditions defined by European legislation (directive 1999/99/EC).

\*\* For Russia.

\*\*\* Outside Europe.

## GT and GTi petrol engines and gearboxes

| Engine  | 1.6 litre THP 205 S&S<br>GT |    | 1.6 litre THP 250 / 270 S&S<br>GTi |
|---|-----------------------------|----|------------------------------------|
| Gearbox   | Manual (6-speed)            |    | Manual<br>(6-speed)                |
| Model code  | L35GT - L45GT               |    | L35GP / L35GN                      |
| Body style  | Hatchback                   | SW | Hatchback                          |
| Cubic capacity (cc)                               | 1 598                       |    | 1 598                              |
| Bore x stroke (mm)                                | 77 x 85.8                   |    | 77 x 85.8                          |
| Max power: EU standard (kW)*                      | 151                         |    | 184 / 200                          |
| Max power engine speed (rpm)                      | 6 000                       |    | 6 000                              |
| Max torque: EU standard (Nm)                      | 285                         |    | 330                                |
| Max torque engine speed (rpm)                     | 1 750                       |    | 1 900                              |
| Fuel  | Unleaded                    |    | Unleaded                           |
| Catalytic converter                               | yes                         |    | yes                                |
| Oil capacity (in litres)                          |                             |    |                                    |
| Engine (with replacement of the filter cartridge) | 4.25                        |    | 4.25                               |

\* The maximum power corresponds to the type approved value on a test bed, under conditions defined by European legislation (directive 1999/99/EC)

## Petrol weights and towed loads (in kg)

| Engine   | 1.2 litre PureTech 82 | 1.2 litre PureTech 110 |       | 1.2 litre PureTech 130 S&S |       |                          |       |
|--|-----------------------|------------------------|-------|----------------------------|-------|--------------------------|-------|
| Gearbox  | Manual (5-speed)      | Manual (5-speed)       |       | Manual (6-speed)           |       | EAT6 automatic (6-speed) |       |
| Model code   | LPHMZ                 | LPHNZ - LRHNZ          |       | LPHNY - LRHNY              |       | LPHNY - LRHNY            |       |
| Body style   | Hatchback             | Hatchback              | SW    | Hatchback                  | SW    | Hatchback                | SW    |
| Unladen weight   | 1 075                 | 1 080                  | 1 190 | 1 090                      | 1 190 | 1 150                    | 1 200 |
| Kerb weight*   | 1 150                 | 1 155                  | 1 265 | 1 165                      | 1 265 | 1 225                    | 1 275 |
| Gross vehicle weight (GVW)                                   | 1 670                 | 1 720                  | 1 825 | 1 750                      | 1 840 | 1 770                    | 1 855 |
| Gross train weight (GTW) on a 12 % gradient                  | 2 395                 | 2 920                  | 2 925 | 3 041                      | 3 040 | 2 970                    | 2 955 |
| Braked trailer (within GTW limit) on a 10 % or 12 % gradient | 750                   | 1 200                  | 1 100 | 1 300                      | 1 200 | 1 200                    | 1 100 |
| Unbraked trailer   | 575                   | 575                    | 630   | 580                        | 630   | 610                      | 635   |
| Recommended nose weight                                      | 75                    | 75                     | 71    | 75                         | 71    | -                        | -     |

The GTW and towed load values indicated are valid up to a maximum altitude of 1 000 metres; the towed load mentioned must be reduced by 10 % for each additional 1 000 metres of altitude.

Do not exceed 60 mph (100 km/h) when towing (comply with the legislation in force in your country).

High ambient temperatures may result in a reduction in the performance of the vehicle to protect the engine; if the ambient temperature is above 37 °C, limit the towed load.

\* The kerb weight is equal to the unladen weight + driver (75 kg).



| Engine  | 1.6 litre VTi 115 |       | 1.6 litre THP 135** / 150*** / 165***         |       |
|---|-------------------|-------|---|-------|
| Gearbox   | Manual (5-speed)  |       | EAT6 automatic (6-speed)                      |       |
| Model code  | LWNFP - LXNFP     |       | L35GL / L35GX / L35GY - L45GL / L45GX / L45GY |       |
| Body style  | Hatchback         | SW    | Hatchback                                     | SW    |
| Unladen weight  | 1 190             | 1 260 | 1 255   | 1 315 |
| Kerb weight*  | 1 265             | 1 335 | 1 330   | 1 390 |
| Gross vehicle weight (GVW)                                      | 1 720             | 1 820 | 1 780   | 1 870 |
| Gross train weight (GTW)<br>on a 12 % gradient                  | 2 320             | 2 420 | 2 380   | 2 470 |
| Braked trailer (within GTW limit)<br>on a 10 % or 12 % gradient | 600               | 600   | 600   | 600   |
| Unbraked trailer  | 600               | 600   | 600   | 600   |
| Recommended nose weight   | 75                | 71    | 75  | 71    |

The GTW and towed load values indicated are valid up to a maximum altitude of 1 000 metres; the towed load mentioned must be reduced by 10 % for each additional 1 000 metres of altitude.

Do not exceed 60 mph (100 km/h) when towing (comply with the legislation in force in your country).

High ambient temperatures may result in a reduction in the performance of the vehicle to protect the engine; if the ambient temperature is above 37 °C, limit the towed load.

\* The kerb weight is equal to the unladen weight + driver (75 kg).

\*\* For Russia.

\*\*\* Outside Europe.

## Petrol GT and GTi weights and towed loads (in kg)

| Engine  | 1.6 litre THP 205 S&S<br>GT |       | 1.6 litre THP 250 / 270 S&S<br>GTi |
|---|-----------------------------|-------|------------------------------------|
| Gearbox   | Manual (6-speed)            |       | Manual (6-speed)                   |
| Model code  | L35GT - L45GT               |       | L35GP / L35GN                      |
| Body style  | Hatchback                   | SW    | Hatchback                          |
| Unladen weight  | 1 200                       | 1 315 | 1 205                              |
| Kerb weight*  | 1 275                       | 1 390 | 1 280                              |
| Gross vehicle weight (GVW)                                      | 1 790                       | 1 880 | 1 790                              |
| Gross train weight (GTW)<br>on a 12 % gradient                  | 3 190                       | 3 180 | -                                  |
| Braked trailer (within GTW limit)<br>on a 10 % or 12 % gradient | 1 400                       | 1 300 | -                                  |
| Unbraked trailer  | 635                         | 695   | -                                  |
| Recommended nose weight   | 75                          | 71    | -                                  |

The GTW and towed load values indicated are valid up to a maximum altitude of 1 000 metres; the towed load mentioned must be reduced by 10 % for each additional 1 000 metres of altitude.

Do not exceed 60 mph (100 km/h) when towing (comply with the legislation in force in your country).

High ambient temperatures may result in a reduction in the performance of the vehicle to protect the engine; if the ambient temperature is above 37 °C, limit the towed load.

\* The kerb weight is equal to the unladen weight + driver (75 kg).

## Diesel engines and gearboxes

| Engine  | 1.6 litre HDi 92 |    | 1.6 litre e-HDi 115 |    | 1.6 litre BlueHDi 100 |    |
|---|------------------|----|---------------------|----|-----------------------|----|
| Gearbox   | Manual (5-speed) |    | Manual (6-speed)    |    | Manual (5-speed)      |    |
| Model code  | LB9HP - LC9HP    |    | LB9HC - LC9HC       |    | LBBHY - LCBHY         |    |
| Body style  | Hatchback        | SW | Hatchback           | SW | Hatchback             | SW |
| Cubic capacity (cc)                               | 1 560            |    |                     |    |                       |    |
| Bore x stroke (mm)                                | 75 x 88.3        |    |                     |    |                       |    |
| Max power: EU standard (kW)*                      | 68               |    | 85                  |    | 73                    |    |
| Max power engine speed (rpm)                      | 4 000            |    | 3 600               |    | 3 750                 |    |
| Max torque: EU standard (Nm)                      | 230              |    | 270                 |    | 254                   |    |
| Max torque engine speed (rpm)                     |                  |    | 1 750               |    |                       |    |
| Fuel  | Diesel           |    |                     |    |                       |    |
| Catalytic converter                               | yes              |    |                     |    |                       |    |
| Particle filter                                   | yes              |    |                     |    |                       |    |
| <b>Oil capacity (in litres)</b>                   |                  |    |                     |    |                       |    |
| Engine (with replacement of the filter cartridge) | 3.75             |    |                     |    |                       |    |

\* The maximum power corresponds to the value type approved on a test bed, under conditions defined by European legislation (Directive 1999/99/EC).

| Engine  | 1.6 litre BlueHDi 120         |    |                               |    |
|---|-------------------------------|----|-------------------------------|----|
| Gearbox   | Manual (6-speed)              |    | EAT6 automatic (6-speed)      |    |
| Model code  | LBBHZ - LBBHX - LCBHZ - LCBHX |    | LBBHT - LBBHX - LCBHT - LCBHX |    |
| Body style  | Hatchback                     | SW | Hatchback                     | SW |
| Cubic capacity (cc)                               | 1 560                         |    |                               |    |
| Bore x stroke (mm)                                | 75 x 88.3                     |    |                               |    |
| Max power: EU standard (kW)*                      | 85** / 88                     |    | 85                            |    |
| Max power engine speed (rpm)                      | 3 500                         |    |                               |    |
| Max torque: EU standard (Nm)                      | 300                           |    |                               |    |
| Max torque engine speed (rpm)                     | 1 750                         |    |                               |    |
| Fuel  | Diesel                        |    |                               |    |
| Catalytic converter                               | yes                           |    |                               |    |
| Particle filter                                   | yes                           |    |                               |    |
| <b>Oil capacity (in litres)</b>                   |                               |    |                               |    |
| Engine (with replacement of the filter cartridge) | 3.75                          |    |                               |    |

\* The maximum power corresponds to the value type approved on a test bed, under conditions defined by European legislation (Directive 1999/99/EC).

\*\* For Belgium.

| Engine  | 2.0 litre BlueHDi 150 |    |                          |    |
|---|-----------------------|----|--------------------------|----|
| Gearbox   | Manual (6-speed)      |    | EAT6 automatic (6-speed) |    |
| Model code  | LHAHX - LJAHX - LJAHR |    | LHAHX - LJAHX            |    |
| Body style  | Hatchback             | SW | Hatchback                | SW |
| Cubic capacity (cc)                               | 1 997                 |    |                          |    |
| Bore x stroke (mm)                                | 85 x 88               |    |                          |    |
| Max power: EU standard (kW)*                      | 110                   |    |                          |    |
| Max power engine speed (rpm)                      | 3 750                 |    |                          |    |
| Max torque: EU standard (Nm)                      | 370                   |    |                          |    |
| Max torque engine speed (rpm)                     | 2 000                 |    |                          |    |
| Fuel  | Diesel                |    |                          |    |
| Catalytic converter                               | yes                   |    |                          |    |
| Particle filter                                   | yes                   |    |                          |    |
| <b>Oil capacity (in litres)</b>                   |                       |    |                          |    |
| Engine (with replacement of the filter cartridge) | 6.1                   |    |                          |    |

\* The maximum power corresponds to the value type approved on a test bed, under conditions defined by European legislation (Directive 1999/99/EC).

## Diesel GT engines and gearboxes

| Engine  | 2.0 litre BlueHDi 180<br>GT   |    |
|---|-------------------------------|----|
| Gearbox   | EAT6 automatic (6-speed)      |    |
| Model code  | LHAHT - LHAHW - LJAHT - LJAHW |    |
| Body style  | Hatchback                     | SW |
| Cubic capacity (cc)                               | 1 997                         |    |
| Bore x stroke (mm)                                | 85 x 88                       |    |
| Max power: EU standard (kW)*                      | 133                           |    |
| Max power engine speed (rpm)                      | 3 750                         |    |
| Max torque: EU standard (Nm)                      | 400                           |    |
| Max torque engine speed (rpm)                     | 2 000                         |    |
| Fuel  | Diesel                        |    |
| Catalytic converter                               | yes                           |    |
| Particle filter                                   | yes                           |    |
| <b>Oil capacity (in litres)</b>                   |                               |    |
| Engine (with replacement of the filter cartridge) | 5.1                           |    |

\* The maximum power corresponds to the value type approved on a test bed, under conditions defined by European legislation (Directive 1999/99/EC).

## Diesel weights and towed loads (in kg)

| Engine  | 1.6 litre HDi 92 |       | 1.6 litre e-HDi 115 |       | 1.6 litre BlueHDi 100 |       |
|---|------------------|-------|---------------------|-------|-----------------------|-------|
| Gearbox   | Manual (5-speed) |       | Manual (6-speed)    |       | Manual (5-speed)      |       |
| Model code  | LB9HP - LC9HP    |       | LB9HC - LC9HC       |       | LBBHY - LCBHY         |       |
| Body style  | Hatchback        | SW    | Hatchback           | SW    | Hatchback             | SW    |
| Unladen weight  | 1 090            | 1 180 | 1 160               | 1 200 | 1 160                 | 1 200 |
| Kerb weight*  | 1 165            | 1 255 | 1 237               | 1 275 | 1 235                 | 1 275 |
| Gross vehicle weight (GVW)                                      | 1 740            | 1 850 | 1 780               | 1 870 | 1 780                 | 1 880 |
| Gross train weight (GTW)<br>on a 12% gradient                   | 3 040            | 3 050 | 3 180               | 3 170 | 3 074                 | 3 080 |
| Unbraked trailer (within GTW limit)<br>on a 10% or 12% gradient | 1 300            | 1 200 | 1 400               | 1 300 | 1 300                 | 1 200 |
| Unbraked trailer  | 580              | 620   | 615                 | 630   | 615                   | 630   |
| Recommended nose weight   | 75               | 71    | 75                  | 71    | 75                    | 71    |

The GTW and towed load values indicated are valid up to a maximum altitude of 1 000 metres; the towed load mentioned must be reduced by 10 % for each additional 1 000 metres of altitude.

Do not exceed 60 mph (100 km/h) when towing (comply with the legislation in force in your country).

High ambient temperatures may result in a reduction in the performance of the vehicle to protect the engine; if the ambient temperature is above 37 °C, limit the towed load.

\* The kerb weight is equal to the unladen weight + driver (75 kg).

| Engine  | 1.6 litre BlueHDi 120         |       |                               |       |
|---|-------------------------------|-------|-------------------------------|-------|
| Gearbox   | Manual (6-speed)              |       | EAT6 automatic (6-speed)      |       |
| Model code  | LBBHZ - LBBHX - LCBHZ - LCBHX |       | LBBHT - LBBHX - LCBHT - LCBHX |       |
| Body style  | Hatchback                     | SW    | Hatchback                     | SW    |
| Unladen weight  | 1 185                         | 1 300 | 1 200                         | 1 310 |
| Kerb weight*  | 1 260                         | 1 375 | 1 275                         | 1 385 |
| Gross vehicle weight (GVW)                                      | 1 810                         | 1 870 | 1 820                         | 1 910 |
| Gross train weight (GTW)<br>on a 12% gradient                   | 3 210                         | 3 170 | 3 120                         | 3 110 |
| Unbraked trailer (within GTW limit)<br>on a 10% or 12% gradient | 1 400                         | 1 300 | 1 300                         | 1 200 |
| Unbraked trailer  | 615                           | 680   | 635                           | 690   |
| Recommended nose weight   | 75                            | 71    | 75                            | 71    |

The GTW and towed load values indicated are valid up to a maximum altitude of 1 000 metres; the towed load mentioned must be reduced by 10 % for each additional 1 000 metres of altitude.

Do not exceed 60 mph (100 km/h) when towing (comply with the legislation in force in your country).

High ambient temperatures may result in a reduction in the performance of the vehicle to protect the engine; if the ambient temperature is above 37 °C, limit the towed load.

\* The kerb weight is equal to the unladen weight + driver (75 kg).



| Engine  | 2.0 litre BlueHDi 150 |       |                          |       |
|---|-----------------------|-------|--------------------------|-------|
| Gearbox   | Manual (6-speed)      |       | EAT6 automatic (6-speed) |       |
| Model code  | LHAHX - LJAHX - LJAHR |       | LHAHX - LJAHX            |       |
| Body style  | Hatchback             | SW    | Hatchback                | SW    |
| Unladen weight  | 1 290                 | 1 315 | 1 310                    | 1 420 |
| Kerb weight*  | 1 365                 | 1 390 | 1 385                    | 1 495 |
| Gross vehicle weight (GVW)                                      | 1 870                 | 1 970 | 1 900                    | 2 000 |
| Gross train weight (GTW)<br>on a 12% gradient                   | 3 465                 | 3 470 | 3 398                    | 3 400 |
| Unbraked trailer (within GTW limit)<br>on a 10% or 12% gradient | 1 600                 | 1 500 | 1 500                    | 1 400 |
| Unbraked trailer  | 680                   | 690   | 690                      | 740   |
| Recommended nose weight   | 75                    | 71    | 75                       | 71    |

The GTW and towed load values indicated are valid up to a maximum altitude of 1 000 metres; the towed load mentioned must be reduced by 10 % for each additional 1 000 metres of altitude.

Do not exceed 60 mph (100 km/h) when towing (comply with the legislation in force in your country).

High ambient temperatures may result in a reduction in the performance of the vehicle to protect the engine; if the ambient temperature is above 37 °C, limit the towed load.

\* The kerb weight is equal to the unladen weight + driver (75 kg).

## Diesel GT weights and towed loads (in kg)

| Engine  | 2.0 litre BlueHDi 180<br>GT   |       |
|---|-------------------------------|-------|
| Gearbox   | EAT6 automatic (6-speed)      |       |
| Model code  | LHAHT - LHAHW - LJAHT - LJAHW |       |
| Body style  | Hatchback                     | SW    |
| Unladen weight  | 1 320                         | 1 425 |
| Kerb weight*  | 1 395                         | 1 500 |
| Gross vehicle weight (GVW)                                      | 1 920                         | 2 020 |
| Gross train weight (GTW)<br>on a 12% gradient                   | 3 420                         | 3 420 |
| Unbraked trailer (within GTW limit)<br>on a 10% or 12% gradient | 1 500                         | 1 400 |
| Unbraked trailer  | 695                           | 750   |
| Recommended nose weight   | 75                            | 71    |

The GTW and towed load values indicated are valid up to a maximum altitude of 1 000 metres; the towed load mentioned must be reduced by 10 % for each additional 1 000 metres of altitude.

Do not exceed 60 mph (100 km/h) when towing (comply with the legislation in force in your country).

High ambient temperatures may result in a reduction in the performance of the vehicle to protect the engine; if the ambient temperature is above 37 °C, limit the towed load.

\* The kerb weight is equal to the unladen weight + driver (75 kg).

# Dimensions (in mm)

These dimensions have been measured on an unladen vehicle.

## Hatchback

## SW

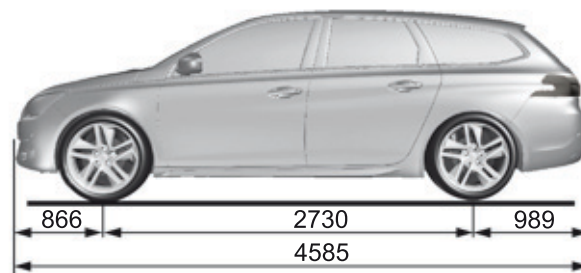
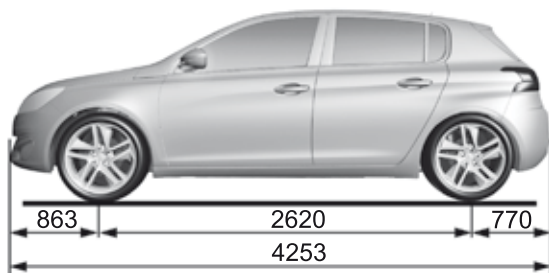
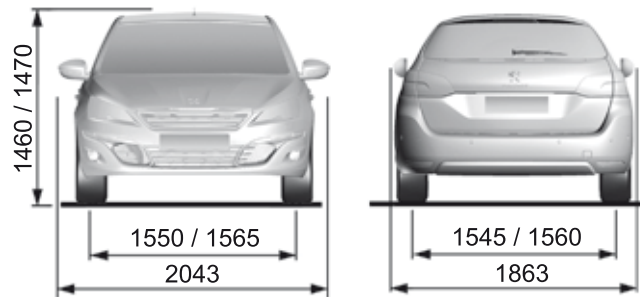
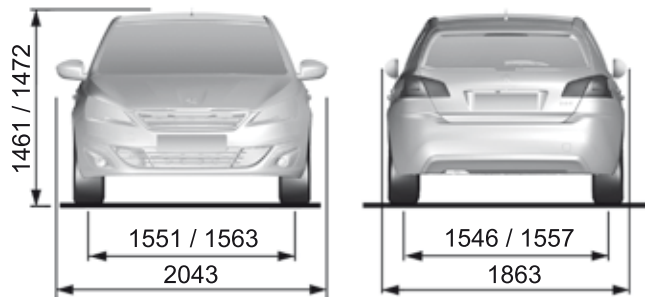

### GT / GTi hatchback\*

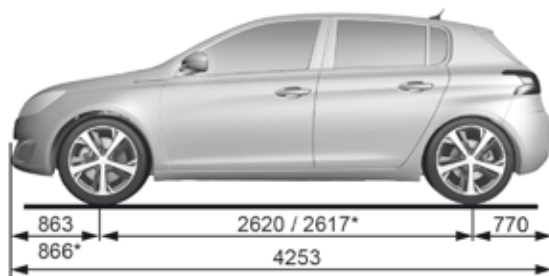
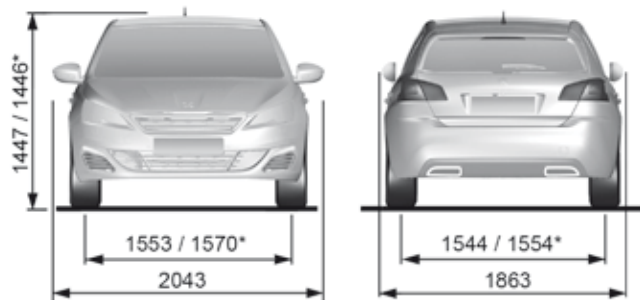

### SW GT

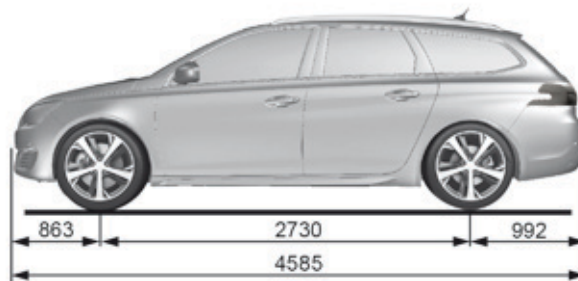
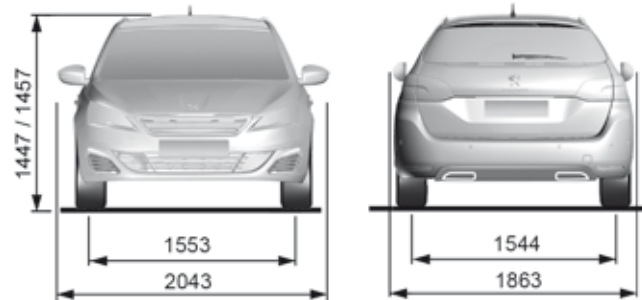

## Affaire version

Number of seats: 2 persons.

Useable boot volume: 1.31 m<sup>3</sup>

|                                | In metres (m) |
|--------------------------------|---------------|
| Load floor length              | 1.458         |
| Load width at the wheel arches | 1.036         |
| Load width at the centre       | 1.077         |
| Load height                    |               |
| - at the centre                | 0.916         |
| - at the load aperture         | 0.831         |
| - below the luggage cover      | 0.5           |

# Identification markings

Various visible markings for the identification of your vehicle.



**A. Vehicle Identification Number (VIN) under the bonnet.**

This number is engraved on the chassis near the right-hand front wheel arch.

**B. Vehicle Identification Number (VIN) on the windscreen lower cross member.**

This number is indicated on a self-adhesive label which is visible through the windscreen.

**C. Manufacturer's label.**

This self-destroying label on the middle door pillar, right or left-hand side, contains the following information:

- the manufacturer's name,
- the European whole vehicle type approval number,
- the vehicle identification number (VIN),
- the maximum authorised weight (gross vehicle weight),
- the maximum authorised weight with trailer (gross train weight),
- the maximum front axle weight,
- the maximum rear axle weight.

**D. Tyre/paint label.**

This label on the middle door pillar, driver's side, contains the following information:

- the tyre inflation pressures, laden and unladen,
- the tyre sizes (including the tyre load index and speed rating),
- the inflation pressure for the spare wheel,
- the paint colour code.

**i** The tyre pressures must be checked when the tyres are cold, at least once a month.

**🍀** If the tyre pressures are too low, this increases fuel consumption.

## DENON equipment



The new DENON Hi-Fi system in the PEUGEOT 308 is a tailored technological solution comprising 9 speakers and a digital amplifier.

The DENON technology offers efficient components providing high performance:

- 4 flexible membrane tweeters with resonance chamber to minimise audio distortion. 100% active at the front of the vehicle.
- 4 CosCone™ woofers: a technology allowing a high level of sensitivity and speaker cone travel, generating high bass performance despite a very flat form.
- 1 sub-woofer with a 100W speaker installed under the boot floor, without affecting the load volume of the boot.
- 1 Class-D 8-way digital amplifier. Improved control of running noises.  
2 audio distribution settings available to suit the number of occupants in the vehicle (driver or passengers).
- "Digital Coloration" technology giving the engine a more sporty and refined sound.

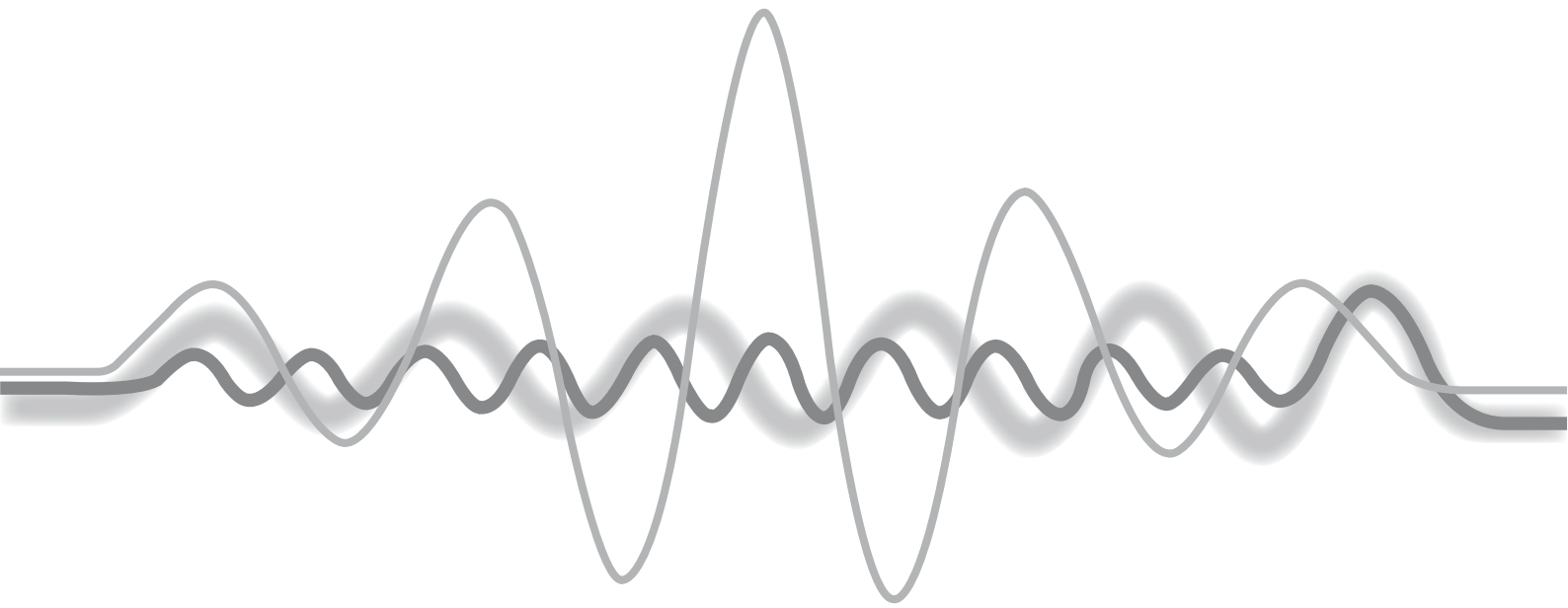



## 7-inch touch screen

### GPS satellite navigation - Multimedia audio - Bluetooth® telephone



|  | Contents |
|--|----------|
| First steps                            | 296      |
| Steering mounted controls              | 299      |
| Menus                                  | 300      |
| Media                                  | 302      |
| Radio                                  | 308      |
| DAB (Digital Audio Broadcasting) radio | 310      |
| Music                                  | 312      |
| Navigation                             | 316      |
| Navigation - Guidance                  | 324      |
| Traffic                                | 328      |
| Configuration                          | 330      |
| Connected services                     | 340      |
| PEUGEOT Connect Apps                   | 341      |
| Telephone                              | 342      |
| Frequently asked questions             | 350      |

**i** The system is protected in such a way that it will only operate in your vehicle.

**!** As a safety measure, the driver should only carry out operations which require prolonged attention while the vehicle is stationary. The display of an energy economy mode message signals that electrical systems operating are going into standby. Refer to the energy economy mode section.

## First steps

Use the buttons on either side of the touch screen for access to the menus, then press the virtual buttons in the touch screen.

Each menu is displayed in one or two pages (primary page and secondary page).

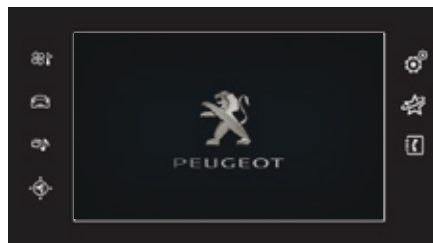

**i** In very hot conditions, the system may go into stand-by (screen and sound completely off) for a minimum period of 5 minutes.

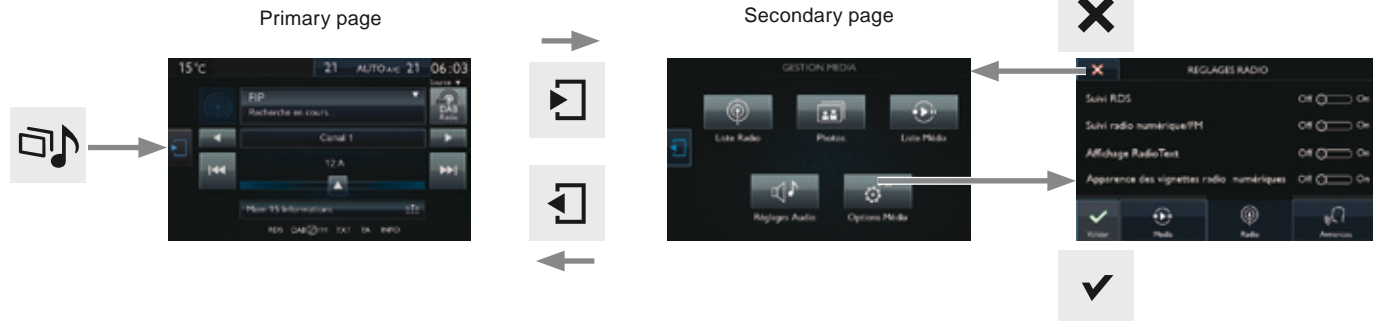

Shortcuts: using virtual buttons in the top band of the touch screen, it is possible to go directly to the choice of audio source, the list of stations (or titles depending on the source) or to the temperature adjustment.

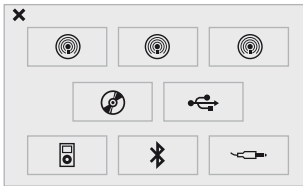

Selecting the audio source (depending on version):

- "FM" / "AM" / "DAB"\* radio wavebands.
- "USB" memory stick.
- CD player (located in the glove box)\*.
- Telephone connected by Bluetooth\* and by Bluetooth\* audio streaming.
- Media player connected to the auxiliary socket (jack, cable not supplied).

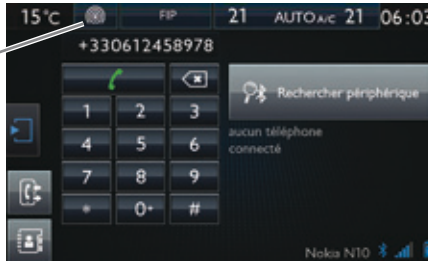

With the engine running, press to mute the sound.  
With the ignition off, press to switch the system on.



Volume adjustment (each source is independent, including Traffic announcements (TA) and navigation instructions).



In very hot conditions, the volume may be limited to protect the system. The return to normal takes place when the temperature in the passenger compartment drops.



The screen is of the "resistive" type, it is necessary to press firmly, particularly for "flick" gestures (scrolling through a list, moving the map...). A simple swipe will not be enough. Pressing with more than one finger is not recognised. The screen can be used when wearing gloves. This technology allows use at all temperatures.



To clean the screen, use a soft non-abrasive cloth (spectacles cloth) without any additional product. Do not use pointed objects on the screen. Do not touch the screen with wet hands.

\* Depending on equipment.

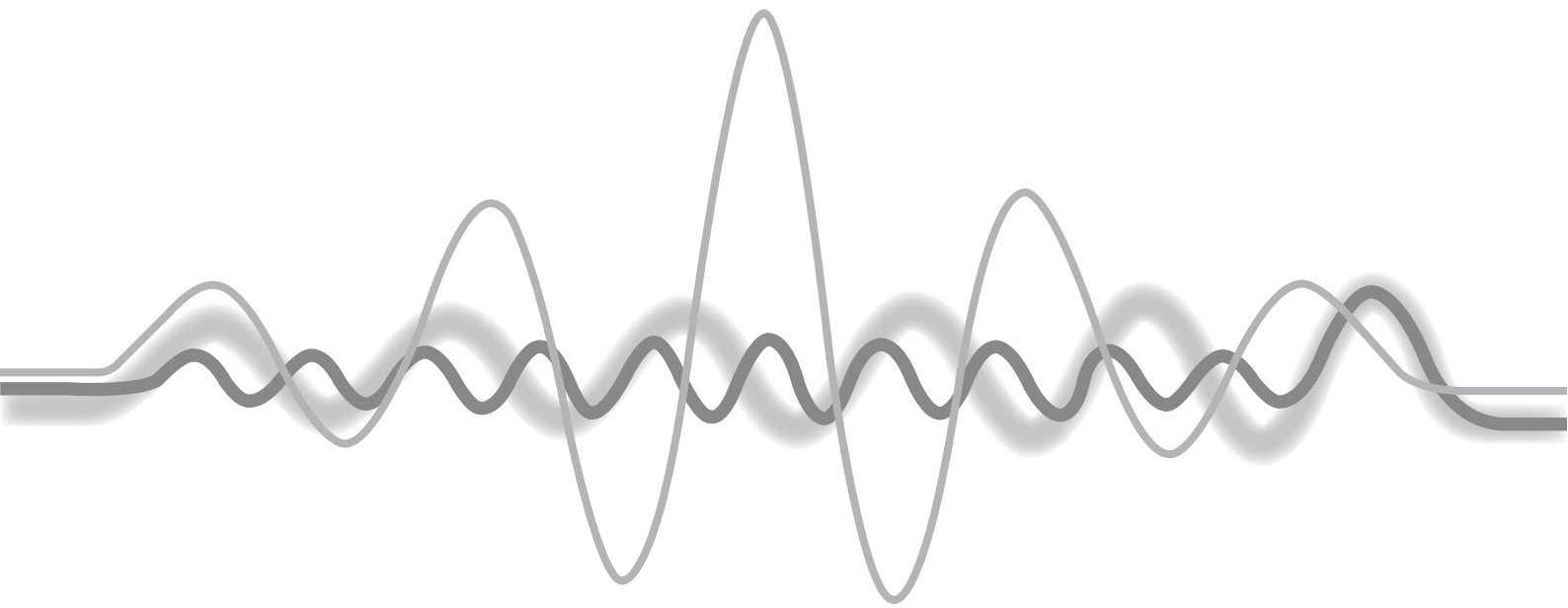

# Steering mounted controls



Press: mute on / off.



Increase volume.



Decrease volume.

**SRC**

Change audio source: radio, media.



Radio, rotate: automatic search for the previous / next station.

Radio, press: preset stations.

Media, rotate: previous / next track.

Press: confirm a selection.



Telephone: start or answer a call.

Call in progress: telephone menu (end call, secret mode, hands-free mode).

Telephone, press and hold: reject an incoming call, end a call in progress; other than call in progress, telephone menu.

Radio: display the list of stations.

Media: display the list of tracks.

Radio, press and hold: update the list of stations received.

# Menus



## Air conditioning



Control of the settings for temperature and air flow.



## Driving assistance



Access to the trip computer. Activate, deactivate, adjust settings for certain vehicle functions.



## Media

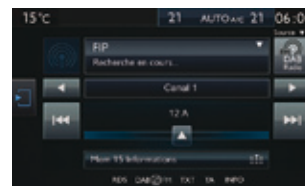

Select an audio source, a radio station, display photographs.



## Navigation

(Depending on equipment)



Enter navigation settings and choose a destination.



## Configuration

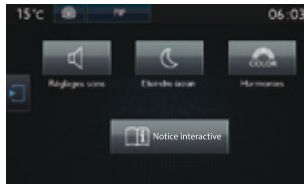

Adjust settings for audio (balance, ambience, ...), colour scheme, brightness of the instruments and controls, display (language, units, date, time, ...) and access the interactive help for the vehicle's main systems and warning lamps.



## Connected services

(Depending on equipment)



### PEUGEOT CONNECT APPS

Connect to an applications portal to facilitate, make safe and personalise journeys by means of a connection key available on subscription from a PEUGEOT dealer.



## Telephone

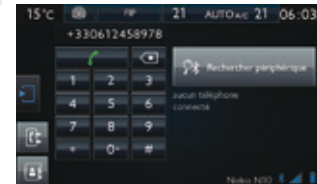





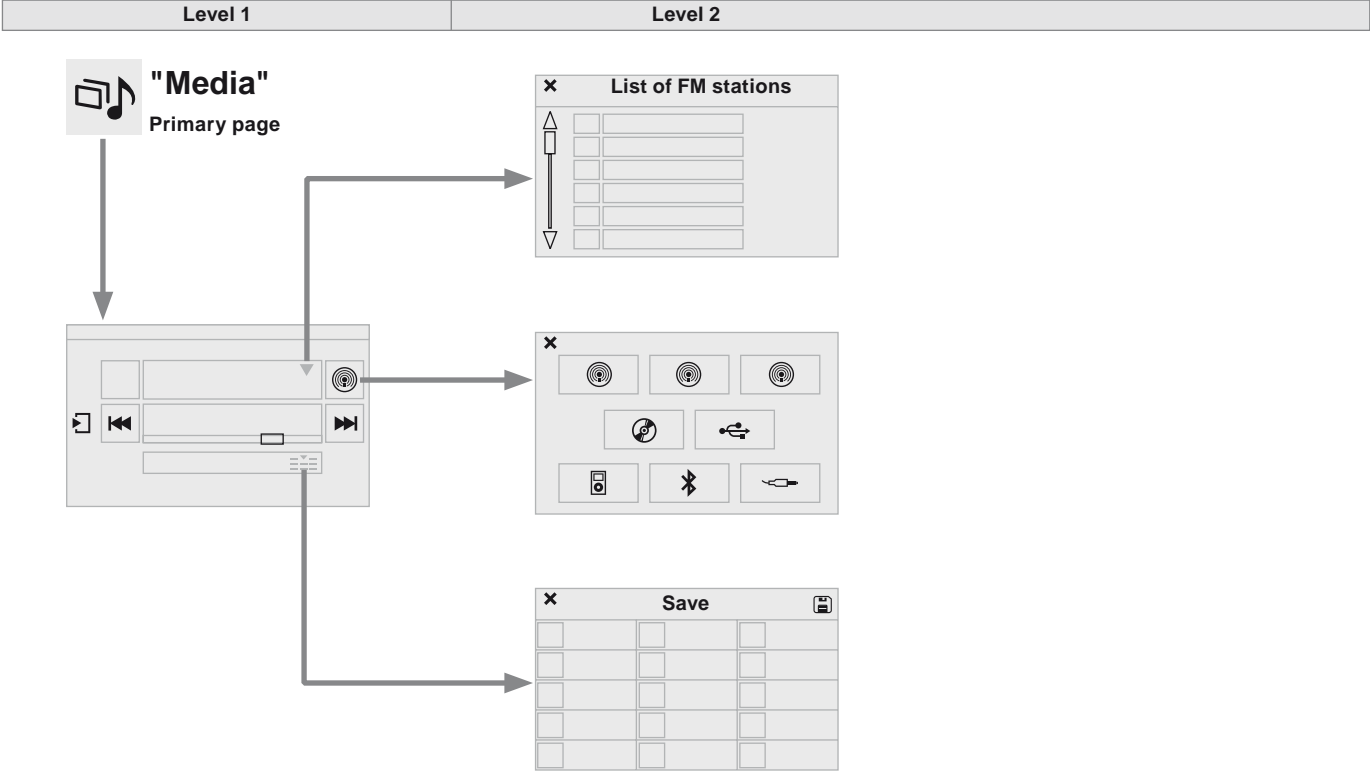











Connect a telephone by Bluetooth®.









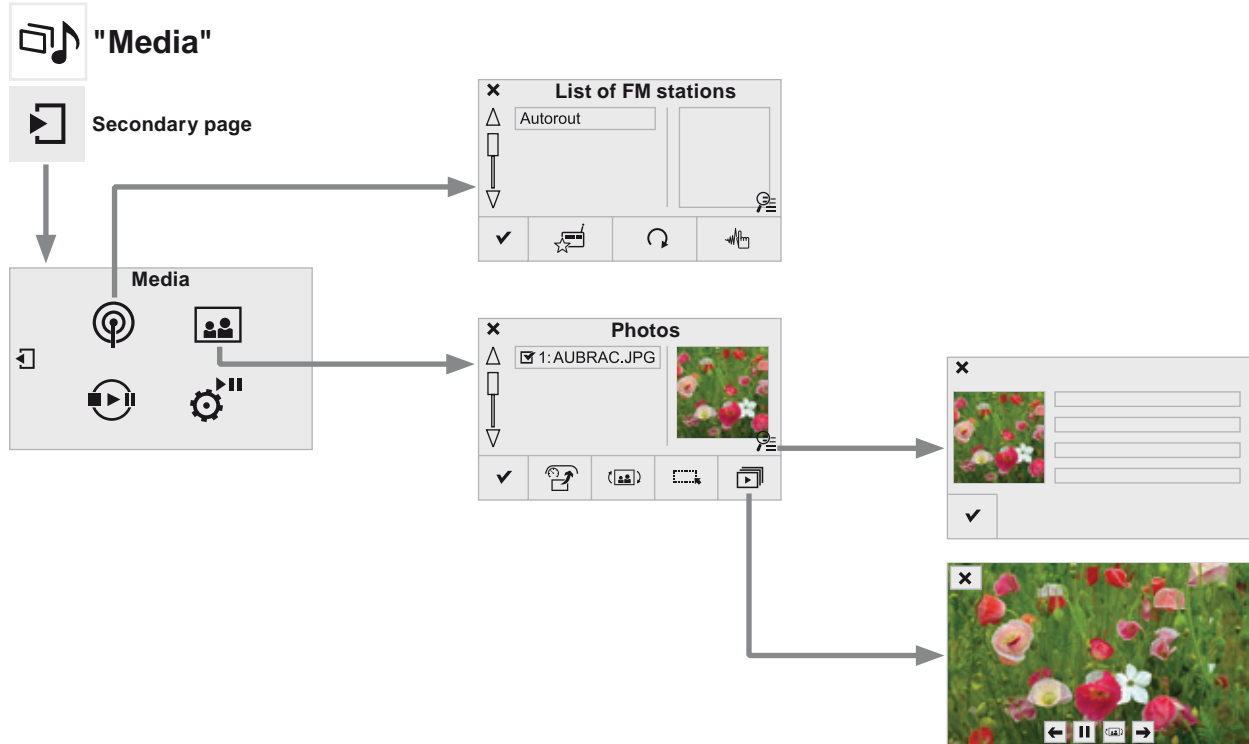









# Media











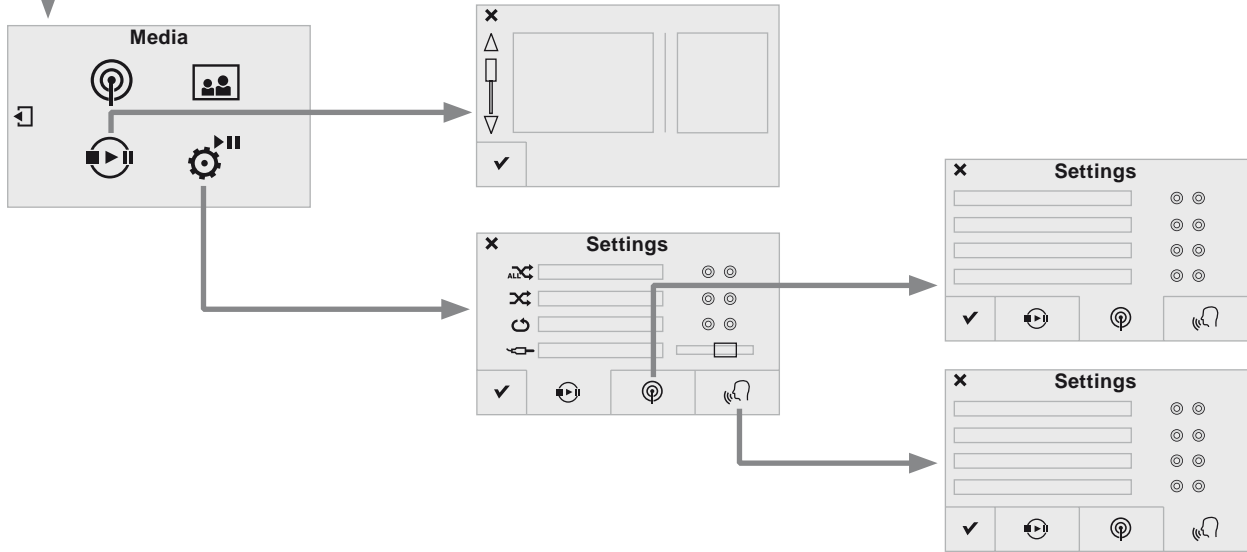
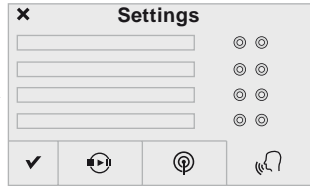
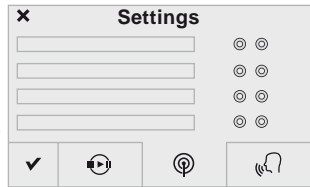
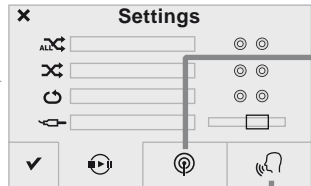
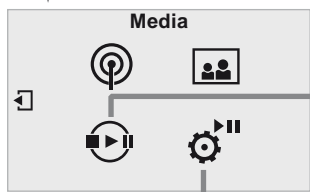







| Level 1  |                                    | Level 2  |                            | Comments                                   |
|--|------------------------------------|--|----------------------------|--|
| <br> | <b>Media</b><br>↓<br><b>List</b>   |   | <b>List of FM stations</b> | Press on a radio station to select it.     |
| <br> | <b>Media</b><br>↓<br><b>Source</b> |  <b>FM Radio</b><br> <b>DAB Radio</b><br> <b>AM Radio</b><br> <b>CD</b><br> <b>USB</b><br> <b>iPod</b><br> <b>Bluetooth</b><br> <b>AUX</b> |                            | Select change of source.                   |
| <br> | <b>Media</b><br>↓<br><b>Save</b>   |   |                            | Press on an empty location then on "Save". |



| Level 1   |   | Level 2  |   | Level 3 |  | Comments   |
|---|---|--|---|---------|--|--|
| <br><br> | Media<br>↓<br>Secondary page<br>↓<br>Radio list   |  Save           |   |         |  | Press on a radio station to select it.                         |
|   |   |  Update list    |   |         |  | Update the list of stations received.                          |
|   |   |  Frequency      |   |         |  | Enter the desired radio frequency.                             |
|   |   |  Confirm        |   |         |  | Save the settings.   |
| <br><br> | Media<br>↓<br>Secondary page<br>↓<br>Photos   |  Page selection |   |         |  | Display the selected photo full screen.                        |
|   |   |  Rotate         |   |         |  | Rotate the photo 90°.  |
|   |   |  Select all     |   |         |  | Select all the photos in the list.<br>Press again to deselect. |
|   |   |  Slideshow      |  Previous photo. |         |  | Display the photos in sequence, full screen.                   |
|   |   |  |  Pause / Play.   |         |  |  |
|   |   |  |  Next photo.     |         |  |  |
|   |  Confirm |  |   |         |  | Save the settings.   |



| Level 1   |   | Level 2   |                                | Level 3   |                                     | Comments                             |                    |
|---|---|---|--------------------------------|---|-------------------------------------|--------------------------------------|--------------------|
| <br><br> | Media<br>↓<br>Secondary page<br>↓<br>Media list |   |                                |   |                                     | Presentation of the last media used. |                    |
| <br><br> | Media<br>↓<br>Secondary page<br>↓<br>Settings   |  | Media<br>↓<br>Settings         |  Shuffle (all tracks)    | Choose the play settings.           |                                      |                    |
|   |   |   |                                |  Shuffle (current album) |                                     |                                      |                    |
|   |   |   |                                |  Repeat                  |                                     |                                      |                    |
|   |   |   |                                |  Aux. amplification      |                                     |                                      |                    |
|   |   |  | Radio<br>↓<br>Settings         | <input type="checkbox"/> RDS options  | Activate or deactivate the options. |                                      |                    |
|   |   |   |                                | <input type="checkbox"/> DAB/FM station tracking  |                                     |                                      |                    |
|   |   |   |                                | <input type="checkbox"/> Display Radio Text   |                                     |                                      |                    |
|   |   |   |                                | <input type="checkbox"/> Digital radio slideshow display  |                                     |                                      |                    |
|   |   |  | Announcements<br>↓<br>Settings | <input type="checkbox"/> Traffic announcements (TA)   | Activate or deactivate the options. |                                      |                    |
|   |   |   |                                | <input type="checkbox"/> Weather  |                                     |                                      |                    |
|   |   |   |                                | <input type="checkbox"/> Sport - Programme info   |                                     |                                      |                    |
|   |   |   |                                | <input type="checkbox"/> Alert settings   |                                     |                                      |                    |
|   |   |  | Confirm                        |   |                                     |                                      | Save the settings. |

# Radio

## Selecting a station



Press on **Media** to display the primary page.

or



Press on **Media** to display the primary page then go to the secondary page.



Select "**List**" in the primary page.

or



Select "**Radio list**" in the secondary page.

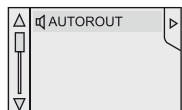

Select a radio station from the list offered.



Select "**Update list**" to refresh the list.

OR



Press on **Media** to display the primary page then select "**Save**".

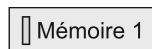

Select a preset radio station in the list.



If necessary, select change of source.



Select "**FM Radio**" or "**AM Radio**".



The exterior environment (hills, buildings, tunnel, car park, below ground...) may prevent reception, even in RDS station tracking mode. This phenomenon is normal in the propagation of radio waves and is in no way indicative of a fault with the audio system.

## Changing a radio frequency



Press on **Media** to display the primary page.

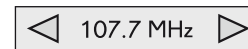

### By automatic frequency search

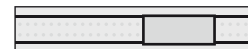

Press ◀ or ▶ to move the cursor for an automatic search down or up for a radio frequency.

OR



Press on **Media** to display the primary page then press on the secondary page.



Press on "**Enter frequency**" to display the primary page then press on the secondary page.

**THEN**

Select the change of source.



Select "**FM Radio**" or "**AM Radio**".

**OR**

Enter the frequency in full (e.g.: 92.10 MHz) using the keypad then "**Confirm**".

FRANCE BLEU

**By alphabetical list**

Press the current radio band then choose the radio station from the list offered.

**Preset a station**

Select a radio station or frequency (refer to the corresponding section).



Press on "**Save**".

Mémoire 1

Select a number in the list to preset the previously chosen radio station.

A long press on a number presets (memorises) the station.

Or



A press on this button presets all of the stations one after the other.

**Recall preset stations**

Press on **Media** to display the primary page then select "**Save**".

**Activate/ Deactivate RDS**

Press on **Media** to display the primary page then go to the secondary page.



Select "**Settings**".



Select "**Radio**".

Off  On

Activate/deactivate "**RDS options**".

**i** RDS, if activated, allows you to continue listening to the same station by automatic retuning to alternative frequencies. However, in certain conditions, coverage of an RDS station may not be assured throughout the entire country as radio stations do not cover 100% of the territory. This explains the loss of reception of the station during a journey.

# DAB (Digital Audio Broadcasting) radio

The screenshot shows a car radio interface with the following elements and annotations:

- 15°C**: Temperature display.
- 21 AUTO A/C 21 06:03**: Climate control and time display.
- Source**: Dropdown menu for audio source selection.
- FIP Recherche en cours...**: Current station name and status.
- Canal 1**: Current multiplex name.
- 12 A**: Current frequency.
- Mem 15 Informations**: Preset stations menu.
- RDS DAB FM TXT TA INFO**: Radio mode and information options.

Annotations and their descriptions:

- Display of the name of the current station.**: Points to the station name 'FIP'.
- Short-cut: access to the choice of audio source, the list of stations (or titles depending on the source) or temperature adjustment.**: Points to the 'Source' dropdown.
- Select the radio station.**: Points to the 'Source' dropdown.
- Select the audio source. Display the "DAB" band.**: Points to the 'DAB' icon in the top right.
- Display of "Radiotext" for the current station.**: Points to the 'Recherche en cours...' text.
- Next "Multiplex". Next radio station.**: Points to the right arrow button.
- Previous "Multiplex". Previous radio station.**: Points to the left arrow button.
- Secondary page.**: Points to the left arrow button.
- Any thumbnail broadcast by the station.**: Points to the radio icon in the top left.
- Display the name and number of the multiplex service being used.**: Points to the 'Canal 1' display.
- Display of options: if active but not available, the display will be greyed out, if active and available, the display will be blank.**: Points to the 'RDS DAB FM TXT TA INFO' bar.
- Preset stations, buttons 1 to 15. Short press: select the preset radio station. Long press: preset a radio station.**: Points to the 'Mem 15 Informations' button.

**i** If the "DAB" radio station being listened to is not available on "FM", the "DAB FM" option is greyed out.

**!** Journaline® is a text-based information service designed for digital radio systems. It provides text-based information structured around topics and sub-topics. This service is available from the "LIST OF DAB STATIONS" page.





## DAB (Digital Audio Broadcasting) Digital radio

**!** Digital radio provides higher quality reception and also the graphical display of current information on the radio station being listened to. Select "List" in the primary page.  
The range of multiplexes available is displayed in alphabetical order.



Press on **Media** to display the primary page.



Select change of source.



Select "**DAB Radio**".



Select "**List**" in the primary page.

or



Select "**Radio list**" in the secondary page.

Select the radio station from the list offered.

## Digital radio - DAB / FM auto tracking

**i** "DAB" does not cover 100% of the territory.  
When the digital radio signal is weak, "DAB/FM station tracking" allows you to continue listening to the same station, by automatically switching to the corresponding "FM" analogue station (if there is one).



Press **Media** to display the primary page then press on the secondary page.



Select "**Settings**".



Select "**Radio**".

Off  On Select "**Digital/FM auto tracking**" then "**Confirm**".

**i** If "DAB/FM station tracking" is activated, there is a difference of a few seconds when the system switches to "FM" analogue radio with sometimes a variation in volume.  
When the digital signal is restored, the system automatically changes back to "DAB".

**!** If the "DAB" station being listened to is not available on "FM" ("**DAB/FM**" option greyed out), or "DAB/FM station tracking" is not activated, the sound will cut out while the digital signal is too weak.

# Music

## USB player

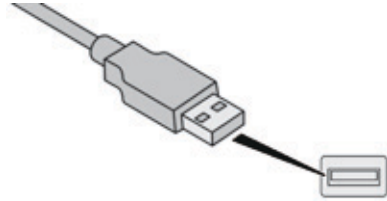

Insert the USB memory stick into the USB port or connect the USB device to the USB port using a suitable cable (not supplied).

**!** To protect the system, do not use a USB hub.

The system builds playlists (in temporary memory), an operation which can take from a few seconds to several minutes at the first connection.

Reduce the number of non-music files and the number of folders to reduce the waiting time.

The playlists are updated every time the ignition is switched off or on connection of a USB memory stick. The lists are memorised: if they are not modified, the subsequent loading time will be shorter.

## Auxiliary socket (AUX)



This source is only available if the "Auxiliary socket" option has been activated in the "Media" settings.

Connect the portable device (MP3 player...) to the auxiliary Jack socket using an audio cable (not supplied).

First adjust the volume of your portable device (to a high level). Then adjust the volume of your audio system.

Display and management of the controls are via the portable device.

## CD player

Insert the CD in the player.

## Selecting the source



Press on **Media** to display the primary page.



Select change of source.

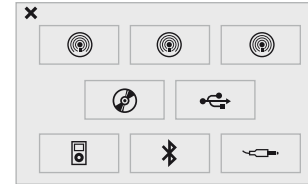

Choose the source.



The steering mounted **SRC** (source) button can be used to go to the next media source, available if the source is active.



Press **OK** to confirm the selection.

## Information and advice

The audio system will only play audio files with ".wma, .aac, .flac, .ogg and .mp3" file extensions and with a bit rate of between 32 Kbps and 320 Kbps.

It also supports VBR (Variable Bit Rate) mode. No other type of file (.mp4, etc.) can be played. ".wma" files must be of the standard wma 9 type. The sampling rates supported are 32, 44 and 48 KHz.

It is advisable to restrict file names to 20 characters, without using of special characters (e.g. " " ? ; ù) to avoid any playing and displaying problems.

In order to be able to play a recorded CDR or CDRW, when recording it is preferable to select the ISO 9660 level 1, 2 or Joliet standard.

If the disc is recorded in another format it may not be played correctly.

It is recommended that the same recording standard is always used for an individual disc, with as low a speed as possible (4x maximum) for optimum sound quality.

In the particular case of a multi-session CD, the Joliet standard is recommended.

Use only USB memory sticks formatted FAT 32 (file allocation table).

 To protect the system, do not use a USB hub.

 It is recommended that the USB cable for the portable device is used.

 The system supports USB mass storage devices, BlackBerry® devices or Apple® players via USB ports. The adaptor cable is not supplied. Control of the peripheral device is with the audio system controls. Other peripherals, not recognised on connection, must be connected to the auxiliary socket using a Jack cable (not supplied).

## Bluetooth® audio streaming

Streaming allows audio files on your telephone to be played through the vehicle's speakers.

Connect the telephone: see the "**Telephone**" section, then "**Bluetooth**".  
Choose the "**Audio**" or "**All**" profile.

If play does not start automatically, it may be necessary to start the audio playback from the telephone.

Control is from the peripheral device or by using the audio system buttons.

- ! Once connected in streaming mode, the telephone is considered to be a media source.  
It is recommended that you activate "**Repeat**" on the Bluetooth peripheral.

## Connecting Apple® players

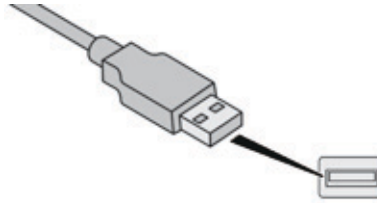

Connect the Apple® player to the USB port using a suitable cable (not supplied).  
Play starts automatically.

Control is via the audio system.





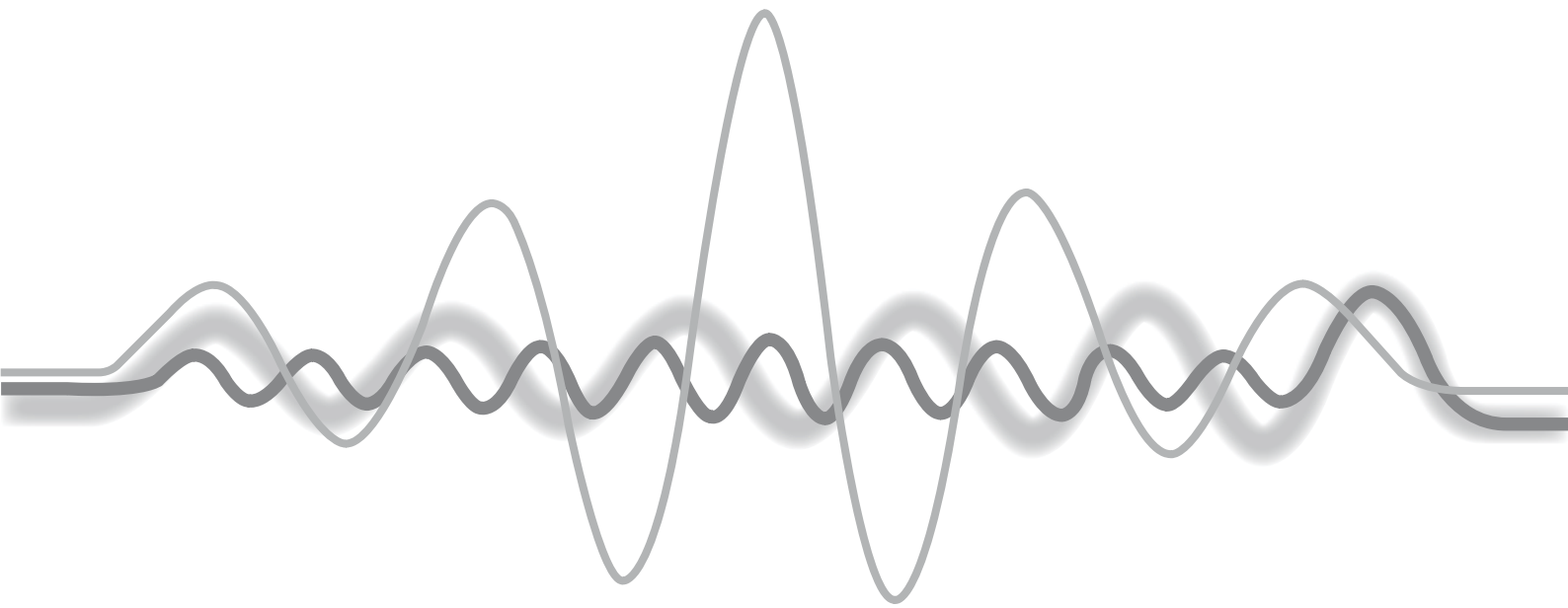



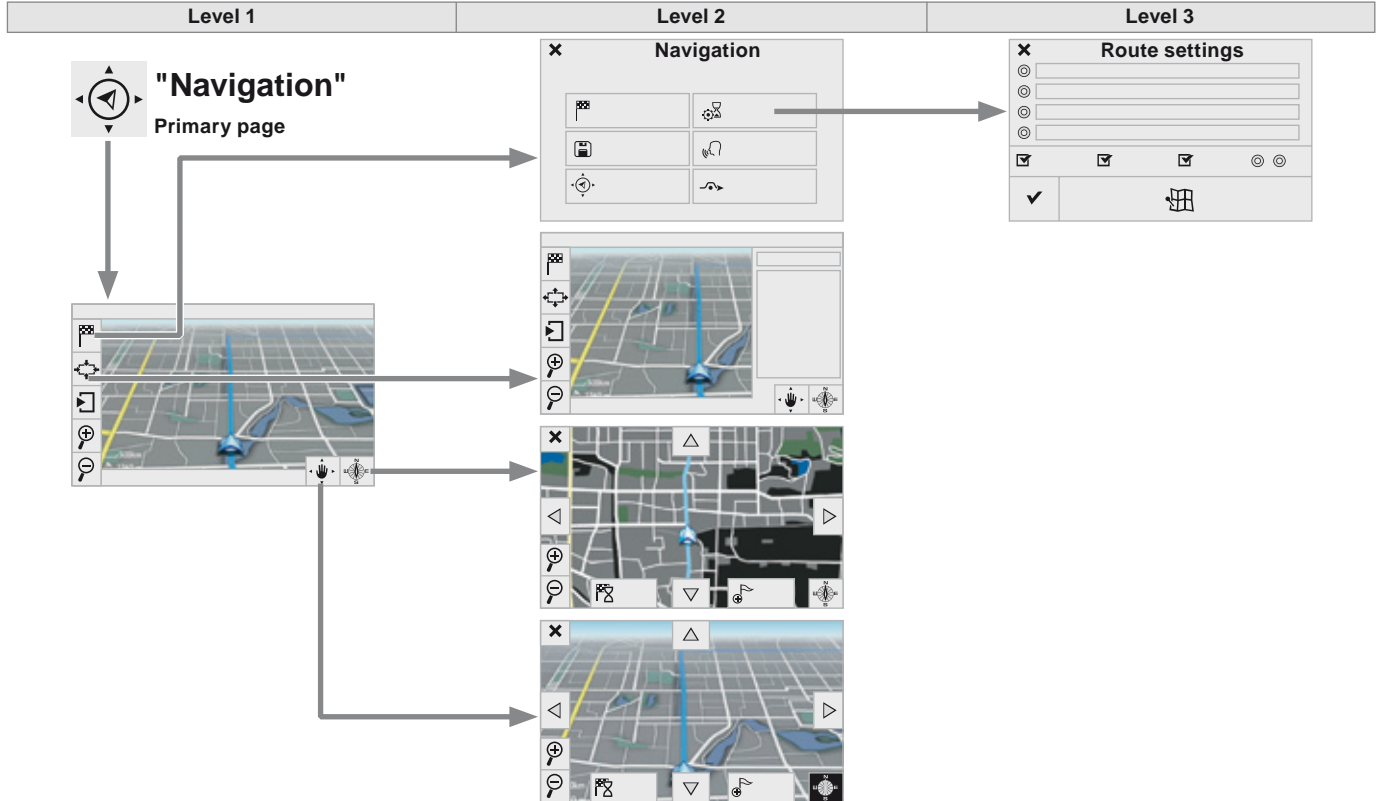















- i The classifications available are those of the portable device connected (artists / albums / genres / playlists / audiobooks / podcasts).  
The default classification used is by artist. To modify the classification used, return to the first level of the menu then select the desired classification (playlists for example) and confirm to go down through the menu to the desired track.

The version of software in the audio system may not be compatible with the generation of your Apple® player.









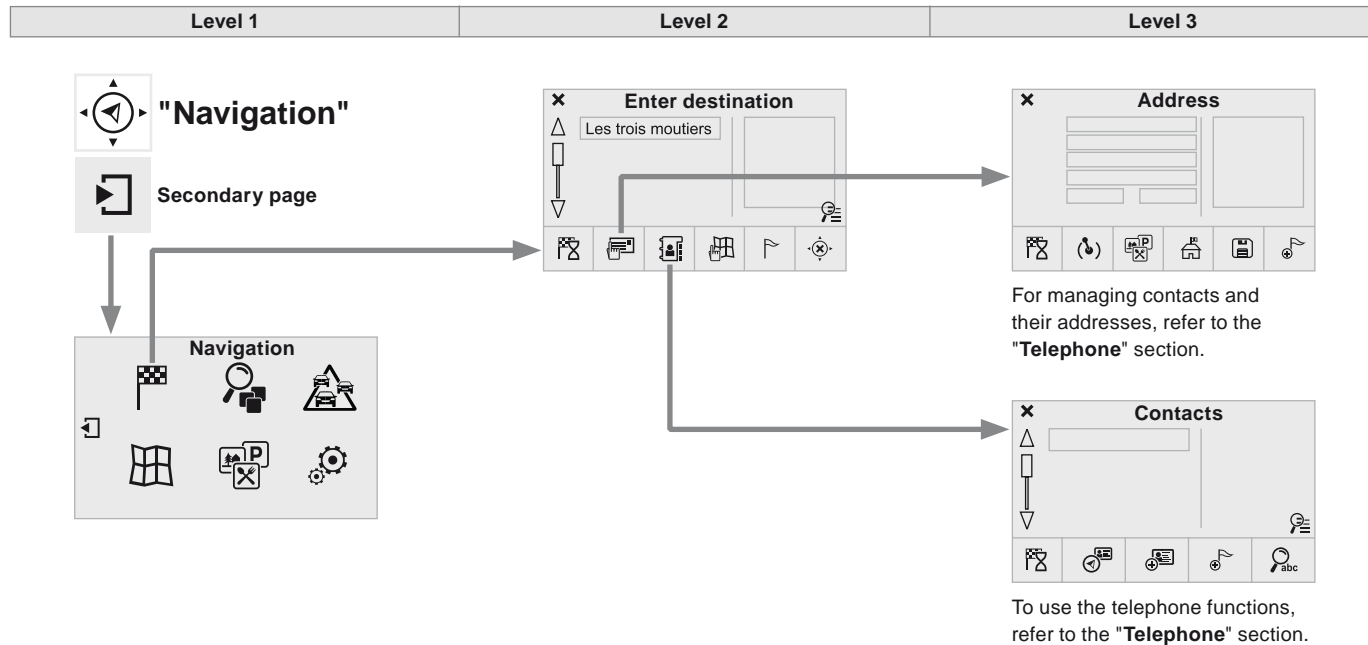













# Navigation









| Level 1  | Level 2   |   | Level 3   |   | Comments  |
|--|---|---|---|---|---|
| <br><br><p style="text-align: center;"><b>Navigation</b><br/>↓<br/><b>Settings</b><br/><b>Navigation</b></p> |  | <b>Enter destination</b>  |   |   | Display recent destinations.  |
|  |  | <b>Route settings</b>   |  | Fastest   | Choose the navigation criteria.<br>The map displays the route chosen according to these criteria. |
|  |   |   |  | Shortest  |   |
|  |   |   |  | Time/distance   |   |
|  |   |   |  | Ecological  |   |
|  |   |   |  | Tolls   |   |
|  |   |   |  | Ferries   |   |
|  |   |   |  | Strict-Close  |   |
|  |   |   |  | Show route on map   |   |
|  |  | Confirm   | Save the options.   |   |   |
|   | <b>Save</b>   |   |   | Save the current address.                                     |   |
|   | <b>Stop navigation</b>  |   |   | Delete the navigation information.                            |   |
|   | <b>Voice</b>  |   |   | Choose the volume for voice and announcement of street names. |   |
|   | <b>Diversion</b>  |   |   | Detour from your initial route by a certain distance.         |   |
| <br><p style="text-align: center;"><b>Navigation</b></p>  |  |   |   | Display in text mode  |   |
|  |  |   |   | Zoom in.  |   |
|  |  |   |   | Zoom out.   |   |
|  |  |  |   |   | Display in full screen mode.<br>Use the arrows to move the map.                                   |
|  |  |   |   | Switch to 2D map.   |   |











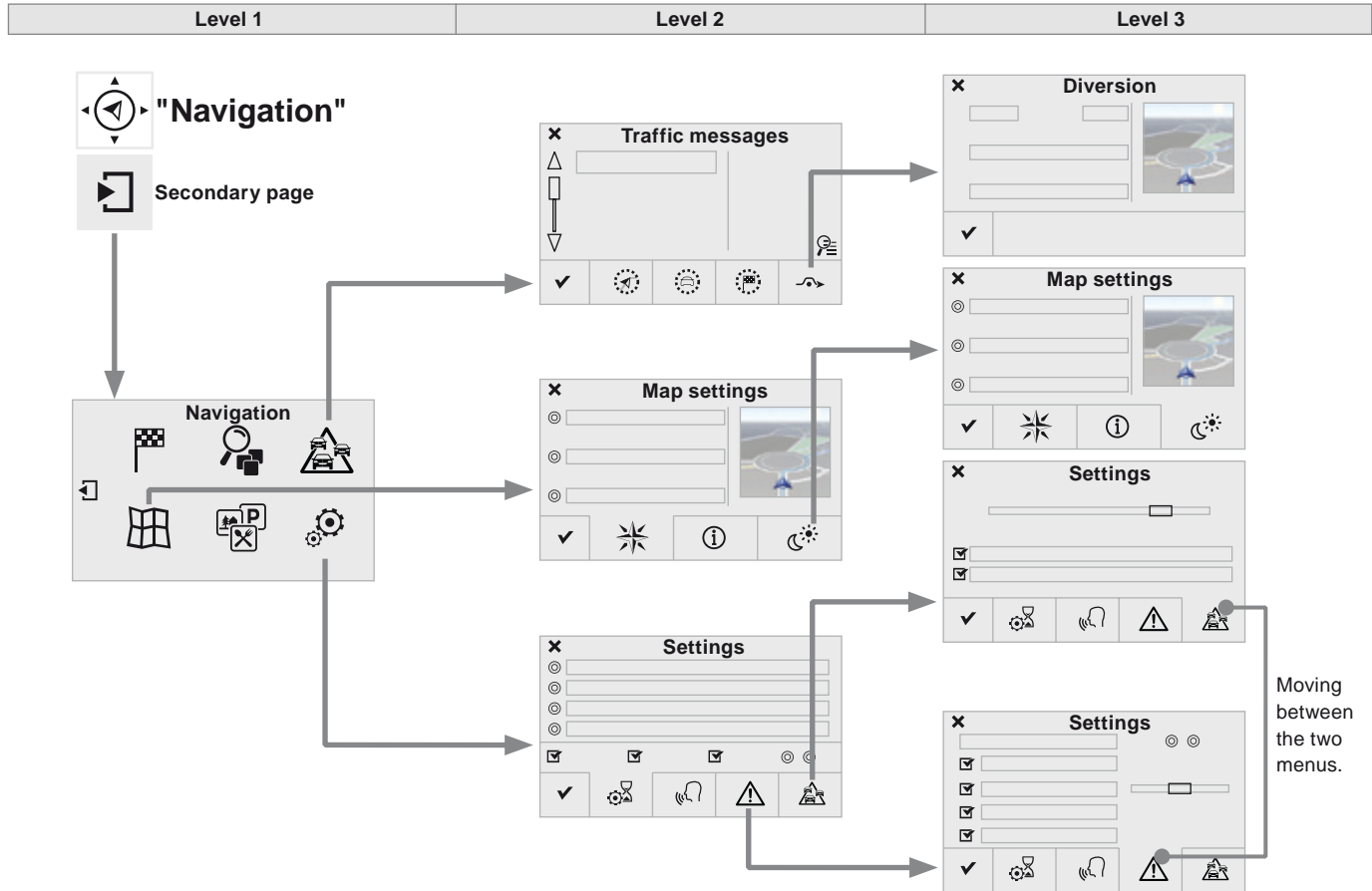













| Level 1   |   | Level 2   |   | Level 3   |                    | Comments                                   |
|---|---|---|---|---|--------------------|--|
| <br><br> | <p style="text-align: center;"> <b>Navigation</b><br/> ↓<br/> <b>Secondary page</b><br/> ↓<br/> <b>Enter destination</b> </p> |  | <b>Address</b>  |  | Current loc.       | Address settings                           |
|   |   |   |   |  | Point of interest  |  |
|   |   |   |   |  | Town center        |  |
|   |   |   |   |  | Save               | Save the current address.                  |
|   |   |   |   |  | Add waypoint       | Add a waypoint to the route.               |
|   |   |   |   |  | Navigate to        | Press to calculate the route.              |
|   |   |  | <b>Contacts</b>   |  | Addresses          | Select a contact then calculate the route. |
|   |   |   |   |  | Add contact        |  |
|   |   |   |   |  | Add waypoint       |  |
|   |   |   |   |  | Search for contact |  |
|    | Navigate to   |   |   |   |                    |  |
|    | <b>On the map</b>   |   | Display the map and zoom to view the roads.             |   |                    |  |
|    | <b>Itinerary</b>  |   | Create, add or delete a waypoint or view the itinerary. |   |                    |  |
|    | <b>Stop</b>   |   | Delete navigation information.                          |   |                    |  |
|    | <b>Navigate to</b>  |   | Press to calculate the route.                           |   |                    |  |



| Level 1   |   | Level 2  |  | Level 3 | Comments   |
|---|---|--|--|---------|--|
| <br><br> | <p>Navigation<br/>↓<br/>Secondary page<br/>↓<br/>Search for POI</p> |  <b>All POIs</b>      |  |         | List of categories available.<br>After choosing the category, select the points of interest. |
|   |   |  <b>Motor</b>         |  |         |  |
|   |   |  <b>Dining/hotels</b> |  |         |  |
|   |   |  <b>Personal</b>      |  |         |  |
|   |   |  <b>By name</b>       |  |         |  |
|   |   |  <b>Search</b>        |  |         | Save the settings.   |
| <br><br> | <p>Navigation<br/>↓<br/>Secondary page<br/>↓<br/>Show POIs</p>      |  <b>Select all</b>    |  |         | Choose the display settings for POIs.  |
|   |   |  <b>Delete</b>        |  |         |  |
|   |   |  <b>Import POIs</b>   |  |         |  |
|   |   |  <b>Confirm</b>       |  |         | Save the options.  |



| Level 1   |  | Level 2   |  | Level 3                |                           | Comments   |  |
|---|--|---|--|------------------------|---------------------------|--|--|
| <br><br> | Navigation<br>↓<br>Secondary page<br>↓<br>Traffic messages |  <b>On the route</b>     |  |                        |                           | Settings for the choice of messages and the filter radius.                           |  |
|   |  |  <b>Around vehicle</b>   |  |                        |                           |  |  |
|   |  |  <b>Near destination</b> |  |                        |                           |  |  |
|   |  |  <b>Detour</b>           | <input type="radio"/>                              | Detour over a distance |                           |  |  |
|   |  |   | <input type="radio"/>                              | Recalculate route      |                           |  |  |
|   | <input checked="" type="checkbox"/> <b>Finish</b>          |   |  |                        |                           | Save your selections.  |  |
| <br><br> | Navigation<br>↓<br>Secondary page<br>↓<br>Map settings     |  <b>Orientation</b>      |  | <input type="radio"/>  | Flat view north heading   | Choose the display and orientation of the map.                                       |  |
|   |  |   |  | <input type="radio"/>  | Flat view vehicle heading |  |  |
|   |  |   |  | <input type="radio"/>  | Perspective view          |  |  |
|   |  |  <b>Maps</b>             |  |                        |                           |  |  |
|   |  |  <b>Aspect</b>           | <input type="radio"/>                              | "Day" map colour       |                           |  |  |
|   |  |   | <input type="radio"/>                              | "Night" map colour     |                           |  |  |
|   |  |   | <input type="radio"/>                              | Automatic day/night    |                           |  |  |
|   | <input checked="" type="checkbox"/> <b>Confirm</b>         |   |  |                        |                           | Save the settings.   |  |
| <br><br> | Navigation<br>↓<br>Secondary page<br>↓<br>Settings         |  <b>Route settings</b>   |  |                        |                           | Enter settings and choose the volume for the voice and announcement of street names. |  |
|   |  |  <b>Voice</b>            |  |                        |                           |  |  |
|   |  |  <b>Alarm!</b>           |  |                        |                           |  |  |
|   |  |  <b>Traffic options</b>  |  |                        |                           |  |  |
|   |  |   | <input checked="" type="checkbox"/> <b>Confirm</b> |                        |                           |  |  |

# Navigation - Guidance

## Choosing a new destination

### Towards a new destination



Press on **Navigation** to display the primary page.



Press on the secondary page.



Select "**Enter destination**".



Select "**Address**".



Select the "**Country**:" from the list offered, then in the same way the "**City**:" or its post code, the "**Road**:", the "**N**°:". Confirm each time.



Select "**Save**" to save the address entered as a contact entry. The system allows up to 200 entries.



Select "**Navigate to**".



Choose the navigation criteria: "**Fastest**" or "**Shortest**" or "**Time/distance**" or "**Ecological**".



Choose the restriction criteria: "**Tolls**", "**Ferries**", "**Traffic**", "**Strict**", "**Close**".



Select "**Confirm**".

Or



Press on "**Show route on map**" to start navigation.



To delete navigation information, press on "**Settings**".



Press on "**Stop navigation**".



To resume navigation press on "**Settings**".



Press on "**Resume guidance**".

## Towards a recent destination



Press on **Navigation** to display the primary page.



Press on the secondary page.



Select "**Enter destination**".

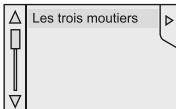

Select an address from the list offered.



Select "**Navigate to**".



Select the criteria then "**Confirm**" or press "**Show route on map**" to start navigation.

## Towards a contact



To be able to use navigation "towards a contact in the directory", it is first necessary to enter the address for your contact.



Press on **Navigation** to display the primary page.



Press on the secondary page.



Select "**Enter destination**".



Select "**Contacts**".

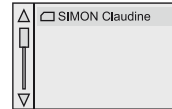

Select a destination from the contacts in the list offered.



Select "**Navigate to**".



Select the criteria then "**Confirm**" to start navigation.

## Towards GPS coordinates



Press on **Navigation** to display the primary page.



Press on the secondary page.



Select "**Enter destination**".



Select "**Address**".



Enter the "**Longitude**:" then the "**Latitude**:".



Select "**Navigate to**".



Select the criteria then "**Confirm**" or press "**Show route on map**" to start navigation.

## Towards a point on the map



Press on **Navigation** to display the primary page.



Press on the secondary page.



Select "**Enter destination**".



Select "**On the map**".

Zooming in on the map shows points with information.

A long press on a point opens its content.

## Towards points of interest (POI)

Points of Interest (POI) are listed in different categories.



Press on **Navigation** to display the primary page.



Press on the secondary page.



Select "**Search for POI**".



Select "**All POIs**".

Or



"**Motor**",

Or



"**Dining/hotels**".



**i** An annual mapping update allows new points of interest to be presented to you.  
You can also update the Risk areas / Danger areas every month.  
The detailed procedure is available on:  
<http://peugeot.navigation.com>.

## Risk areas / Danger zone alert settings



Press on **Navigation** to display the primary page.



Press on the secondary page.



Select "**Settings**".



Select "**Alarm!**" (Alert).

It is then possible to activate Risk areas alerts then:

- "Audible warning"
- "Alert only when navigating"
- "Alert only for overspeed"
- "Display speed limits"
- Timing: the choice of timing allows the time before giving a Risk areas alert to be defined.



Select "**Confirm**".

**!** This series of alerts and displays is only available if Risk areas have first been downloaded and installed on the system.

## Traffic

### Traffic information

#### Display of messages



Press on **Navigation** to display the primary page.



Press on the secondary page.



Select "**Traffic messages**".

Choose filter settings for:



"**On the route**",



"**Around**",



"**Near destination**", filters to fine-tune the list of messages.

Press again to remove the filter.

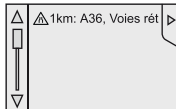

Select the message from the list offered.



Select the magnifying glass to have voice information.

**i** TMC (Traffic Message Channel) messages on GPS-Navigation contain traffic information transmitted in real time.

## Setting filters



Press on **Navigation** to display the primary page.



Press on the secondary page.



Select "**Settings**".



Select "**Traffic options**".



Select:

- "**Be advised of new messages**",
- "**Speak messages**".

Then enter the filter radius.



Select "**Confirm**".

**i** We recommend a filter radius of:

- 12 miles (20 km) in urban areas,
- 30 miles (50 km) on motorways.

## Receiving TA messages



Press on **Navigation** to display the primary page.



Press on the secondary page.



Select "**Settings**".



Select "**Voice**".









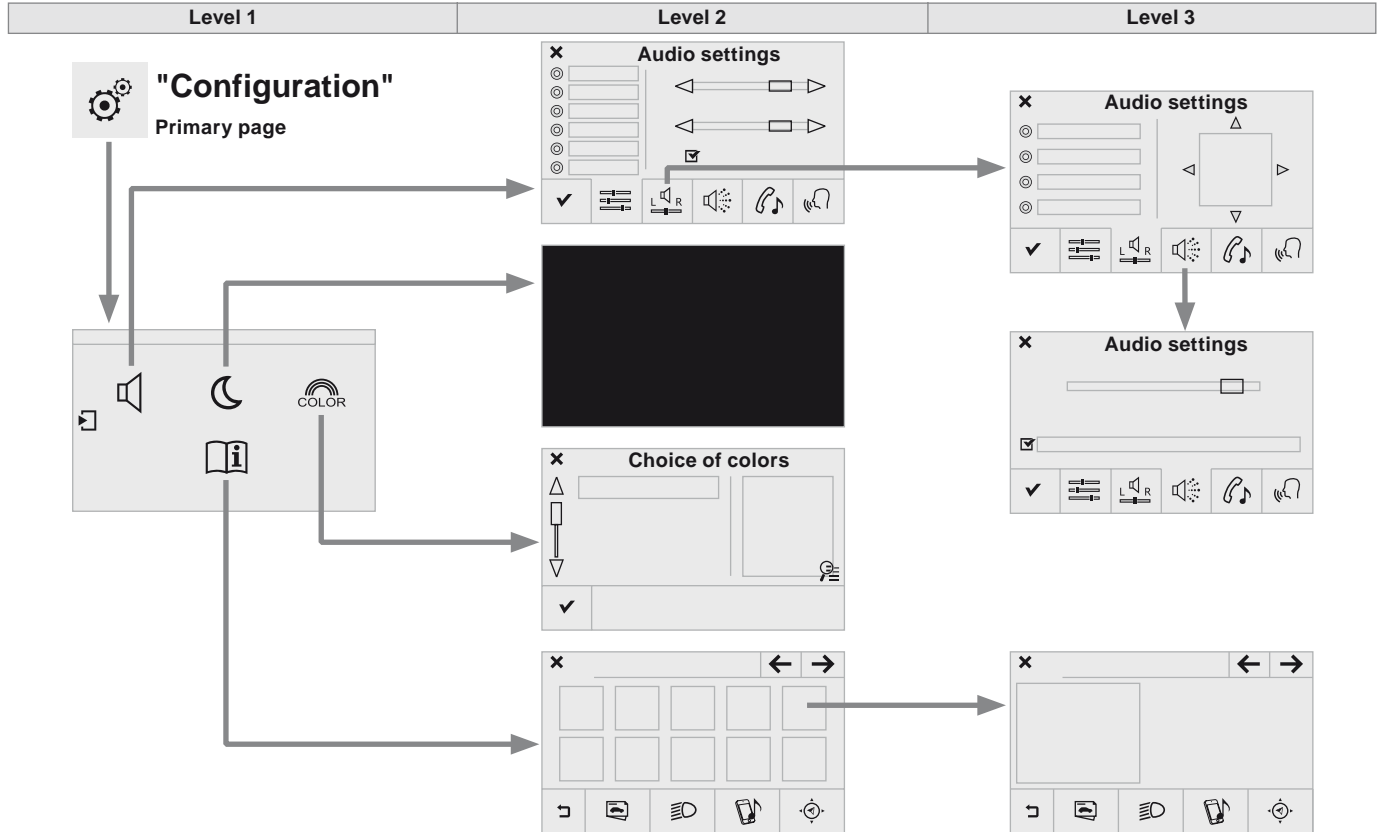













Off  On

Activate / Deactivate "**Traffic (TA)**".









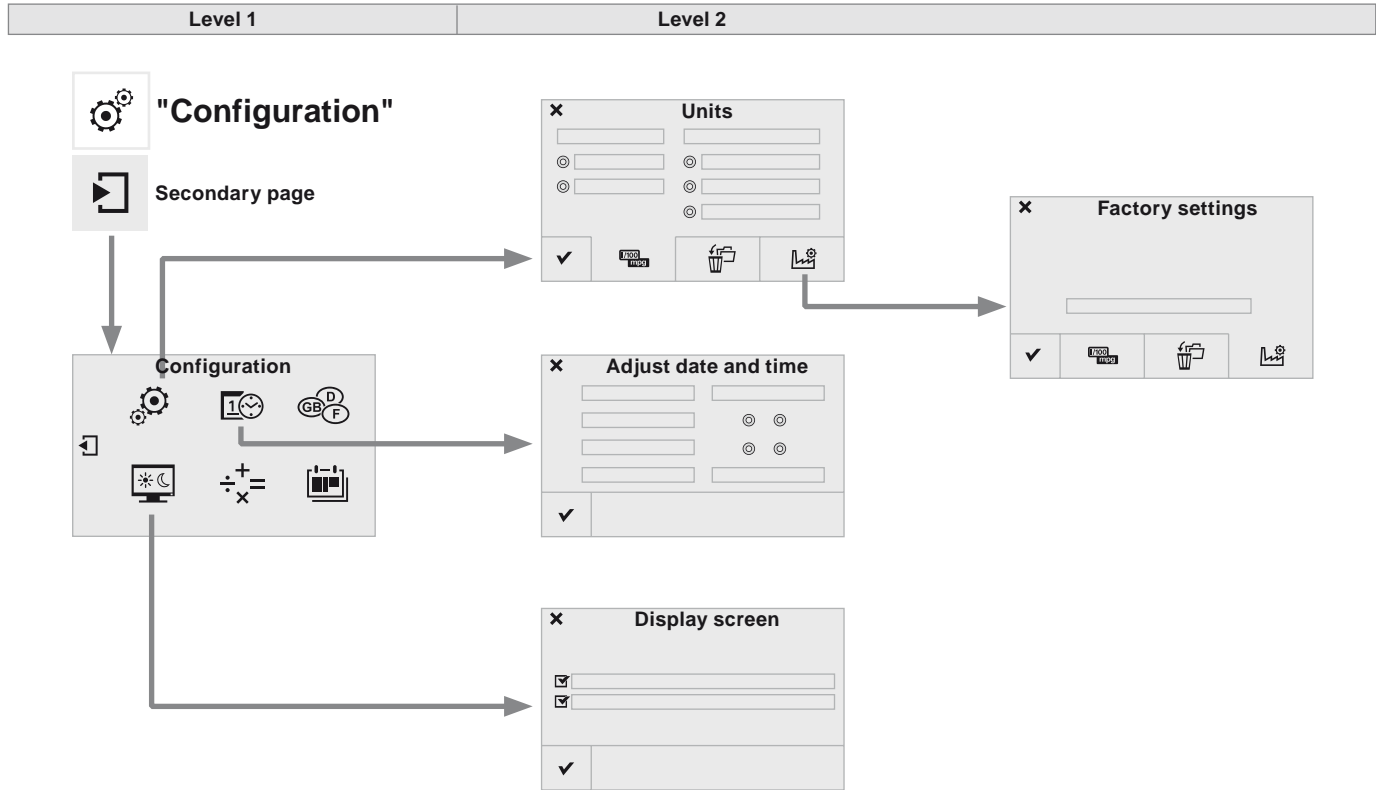





**i** The TA (Traffic Announcement) function gives priority to TA alert messages. To operate, this function needs good reception of a radio station transmitting this type of message. When a traffic report is transmitted, the current audio source is interrupted automatically to play the TA message. Normal playback of the audio source resumes at the end of the transmission of the message.

# Configuration









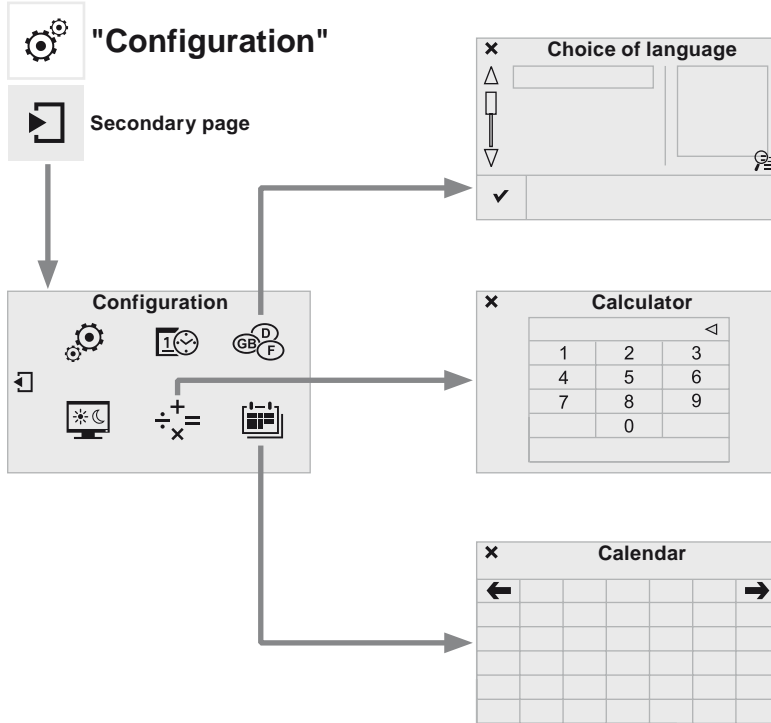

| Level 1  |  | Level 2   |  | Level 3 | Comments  |
|--|--|---|--|---------|---|
| <br> | <b>Configuration</b><br>↓<br><b>Audio settings</b>   |  <b>Ambience</b>   |  |         | Choose the sound ambience.  |
|  |  |  <b>Balance</b>  |  |         | Set the position of the sound in the vehicle using the Arkamys® system.               |
|  |  |  <b>Sound effects</b>  |  |         | Choose the volume or activate the link to vehicle speed.                              |
|  |  |  <b>Ringtones</b>  |  |         | Choose the telephone ringtone and volume.   |
|  |  |  <b>Voice</b>  |  |         | Choose the volume for the voice and announcement of street names.                     |
|  |  |  <b>Confirm</b>  |  |         | Save the settings.  |
| <br> | <b>Configuration</b><br>↓<br><b>Turn off screen</b>  |    |  |         | Turns off the display (black screen). Pressing the black screen restores the display. |
| <br> | <b>Configuration</b><br>↓<br><b>Color schemes</b>    |  <b>Confirm</b>  |  |         | After choosing the color scheme, save the setting.                                    |
| <br> | <b>Configuration</b><br>↓<br><b>Interactive help</b> |  <b>Go back</b><br> <b>Driving assistance - Equipment</b><br> <b>Warning lamps</b><br> <b>Audio communication</b><br> <b>GPS Navigation</b><br> <b>Previous page</b><br> <b>Next page</b> |  |         | Consult the Interactive help.   |



| Level 1   |   | Level 2   |  | Comments  |
|---|---|---|--|---|
| <br><br> | <b>Configuration</b><br>↓<br><b>Secondary page</b><br>↓<br><b>System Settings</b> |  | <b>Units</b>                             | Set the units used to display distance, fuel consumption and temperature. |
|   |   |  | <b>Delete data</b>                       | Select the desired data in the list then press Delete.                    |
|   |   |  | <b>Factory settings</b>                  | Return to factory settings.   |
|   |   |  | <b>Confirm</b>                           | Save the settings.  |
| <br><br> | <b>Configuration</b><br>↓<br><b>Secondary page</b><br>↓<br><b>Time/Date</b>       |  | <b>Confirm</b>                           | Set the date and time then confirm.                                       |
| <br><br> | <b>Configuration</b><br>↓<br><b>Secondary page</b><br>↓<br><b>Screen settings</b> | <input checked="" type="checkbox"/>   | <b>Activate automatic text scrolling</b> | Make the setting then confirm.  |
|   |   | <input checked="" type="checkbox"/>   | <b>Activate animations</b>               |   |
|   |   |  | <b>Confirm</b>                           |   |





| Level 1   |  | Level 2 |                | Comments                          |
|---|--|---------|----------------|-----------------------------------|
| <br><br> | <b>Configuration</b><br>↓<br><b>Secondary page</b><br>↓<br><b>Languages</b>  | ✓       | <b>Confirm</b> | Select the language then confirm. |
| <br><br> | <b>Configuration</b><br>↓<br><b>Secondary page</b><br>↓<br><b>Calculator</b> |         |                | Select the calculator.            |
| <br><br> | <b>Configuration</b><br>↓<br><b>Secondary page</b><br>↓<br><b>Calendar</b>   |         |                | Select the calendar.              |

## Audio settings



Press on **Configuration** to display the primary page.



Select "**Audio settings**".



Select "**Ambience**" or "**Balance**" or "**Sound effects**" or "**Ringtones**" or "**Voice**".



**!** The distribution (or spatialisation using the Arkamys® system) of sound is an audio process that allows the audio quality to be adapted to the number of listeners in the vehicle. Available only with the 6-speaker configuration.

**!** The audio settings (**Ambience**, **Bass**, **Treble**: and **Loudness**) are different and independent for each sound source. The settings for **Distribution** and **Balance** are common to all sources.

- !**
- "**Ambience**" (choice of 6 musical ambiances)
  - "**Bass**:"
  - "**Treble**:"
  - "**Loudness**" (Activate/Deactivate)
  - "**Balance**" ("**Driver**", "**All passengers**", "**Front only**")
  - "**Audible response from touch screen**"
  - "**Volume linked to speed**" (Activate/Deactivate)

**i** On-board audio: Arkamys® Sound Staging optimises sound distribution in the passenger compartment.

## Color schemes



Press on **Configuration** to display the primary page.



Select "**Color schemes**".



Select the colour scheme in the list, then "**Confirm**".

**i** At each change of colour scheme the system restarts, showing a black screen for a few moments.

**!** As a safety measure, the procedure for changing the color scheme is only possible with the vehicle stationary.

## Interactive help



Press on **Configuration** to display the primary page.



Select "**Interactive help**".

**i** The "Interactive help" included in the system is not intended to be a substitute for the more complete content of the printed handbook.

**!** As a safety measure, consultation of the handbook is only possible with the vehicle stationary.

## System

### Modify system settings



Press on **Configuration** to display the primary page then go to the secondary page.



Select "**System Settings**".



Select "**Units**" to change the units of distance, fuel consumption and temperature.



Select "**Delete data**" to delete the list of recent destinations, personal points of interest, contacts in the list. Choose the item then select "**Delete**".



Select "**Factory settings**" to return to the original settings.



Press on **Configuration** to display the primary page then go to the secondary page.



Select "**Screen settings**".



Activate or deactivate "**Activate automatic text scrolling**" and "**Activate animations**".



Press on **Configuration** to display the primary page then go to the secondary page.



Select:

- "**Time/Date**" to change the time zone, synchronisation with GPS, the time and its format and then the date.
- "**Languages**" to change the language.
- "**Calculator**" to display a calculator.
- "**Calendar**" to display a calendar.



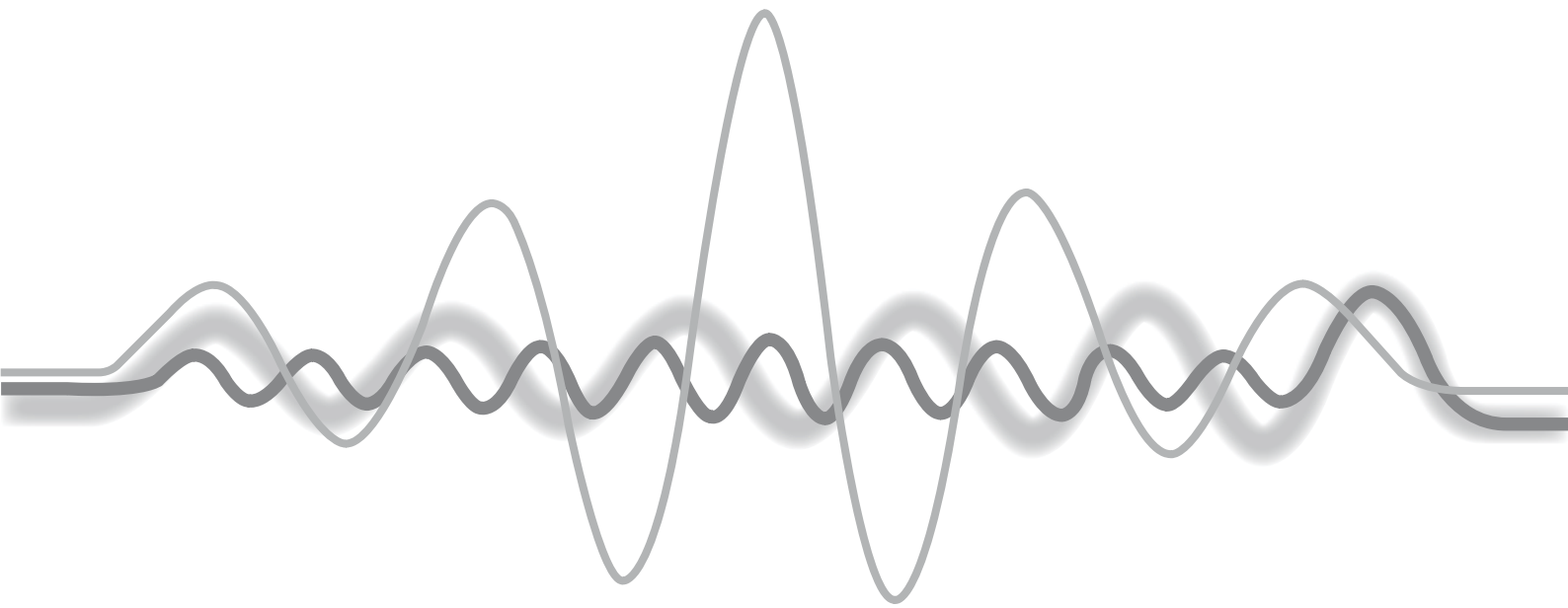

# Connected services

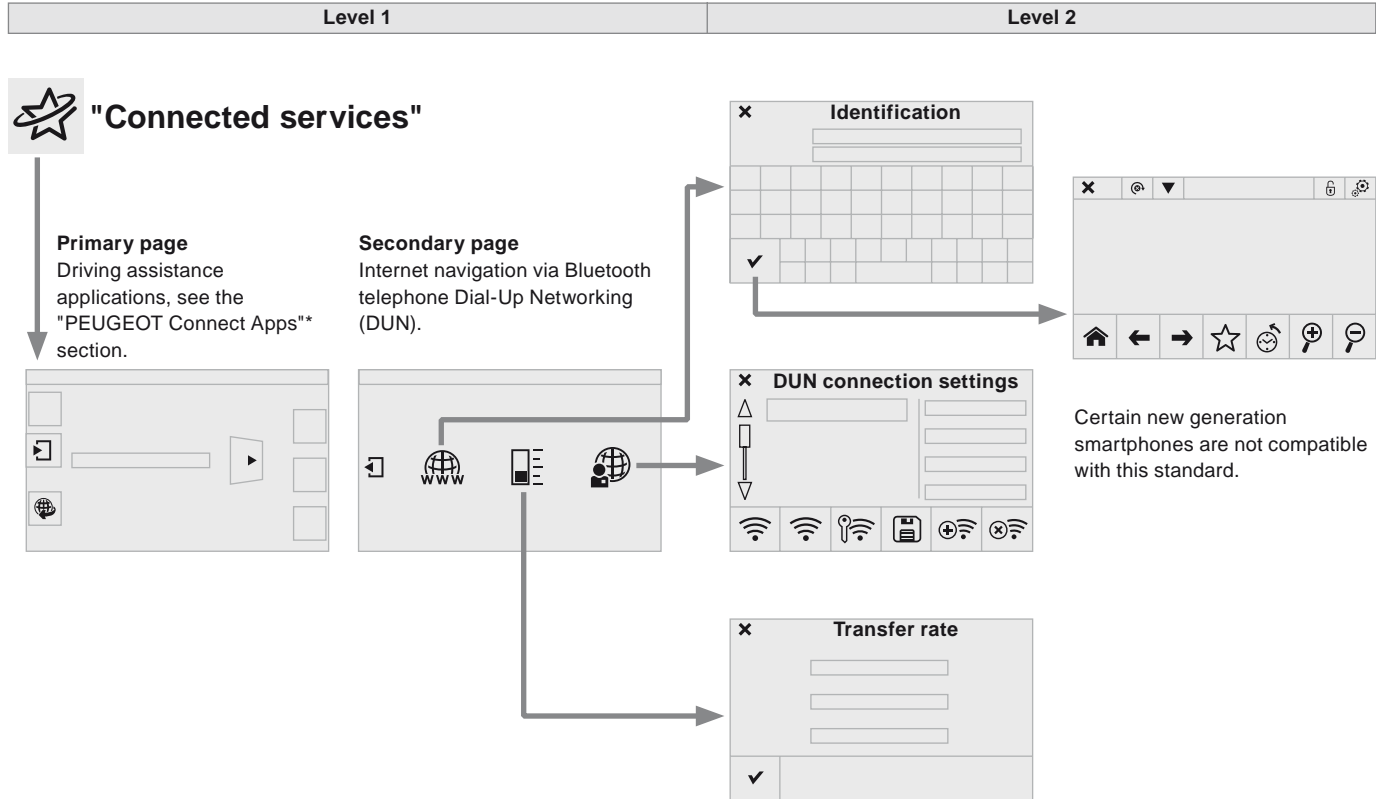

Certain new generation smartphones are not compatible with this standard.

\* Depending on country.

# PEUGEOT Connect Apps

**!** "PEUGEOT Connect Apps"\* is a service providing driving aid applications in real time; it gives access to useful information such as the state of the traffic, danger zones, fuel prices, the availability of parking places, tourist sites, weather conditions, correct addresses...

It includes access to the mobile network associated with the use of these applications. "PEUGEOT Connect Apps"\* is a service available under subscription contract from PEUGEOT dealers, depending on country and the type of touch screen, both before and after delivery of a new vehicle.



Plug the "PEUGEOT Connect Apps" connection key into the USB port.

\* Depending on country.



Press on the "Connected services" menu to display the applications.

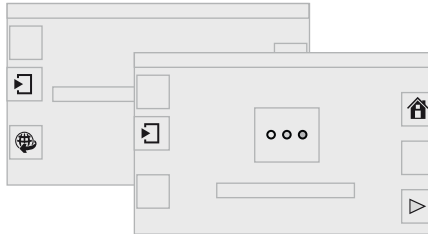

These applications use vehicle data such as the current speed, mileage, remaining fuel range or even GPS position to provide pertinent information.



As a safety measure, some functions can only be used when stationary.



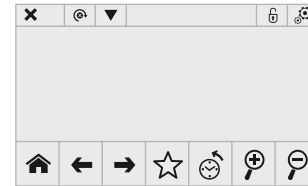



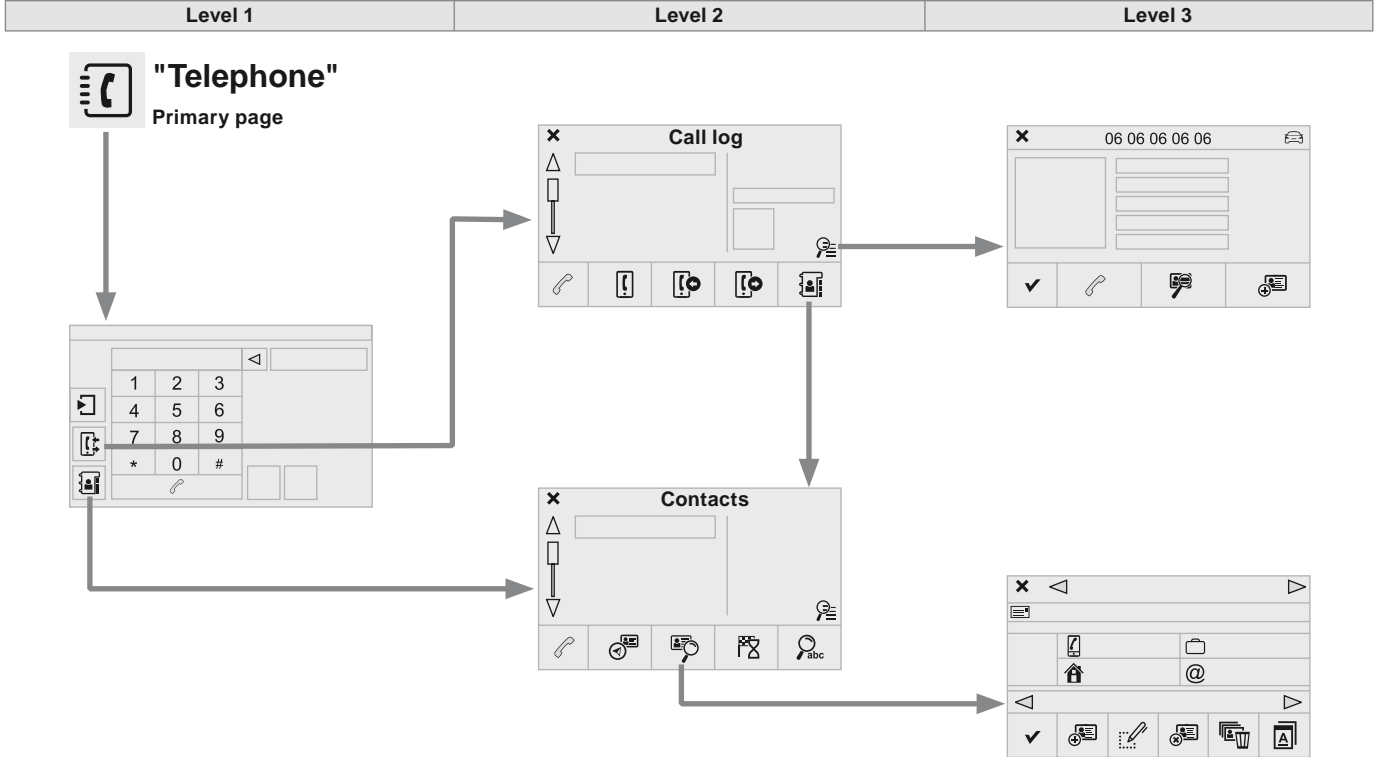















The "MyPEUGEOT" application is a link between the user, the manufacturer and its dealer network. It allows the customer to know everything about their vehicle: servicing plan, accessory range, service contracts taken out, ... It also makes possible the sending of the vehicle's mileage to the "MyPEUGEOT" site, or to identify a dealer.











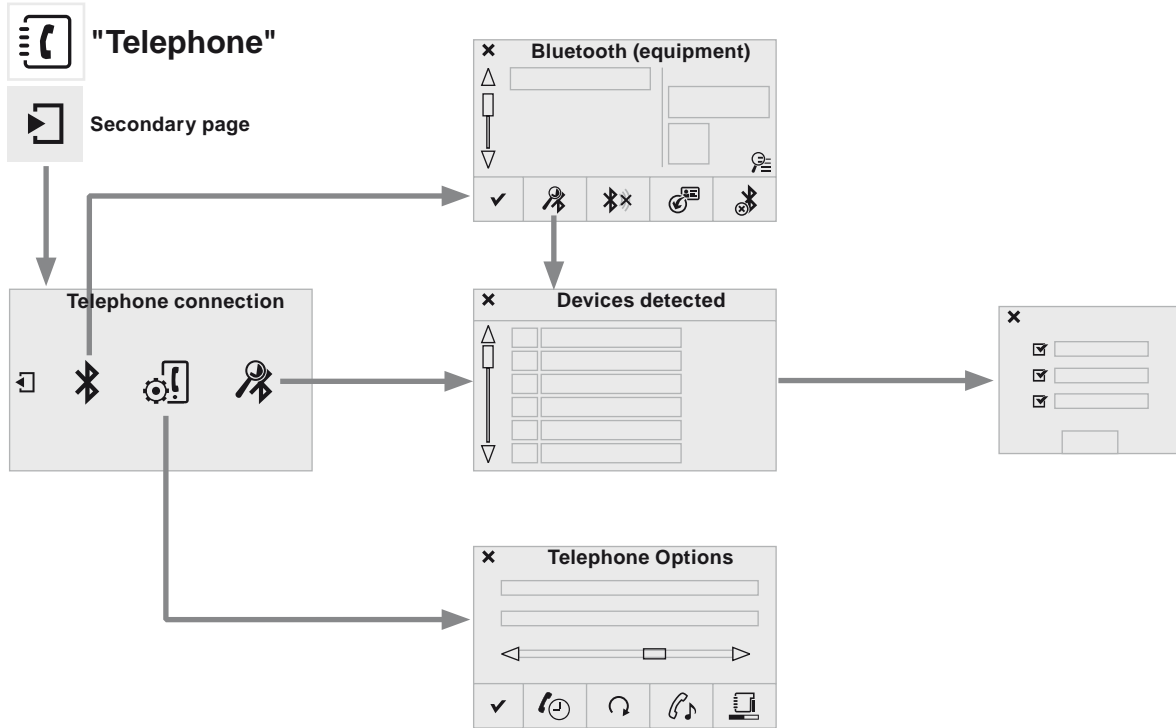











# Telephone





| Level 1  |  | Level 2   |  | Level 3 |  | Comments                              |
|--|--|---|--|---------|--|---------------------------------------|
| <br> | <b>Telephone</b><br>↓<br><b>Call log</b> |  <b>All calls</b>          |  |         |  | After making choices, start the call. |
|  |  |  <b>Incoming calls</b>     |  |         |  |                                       |
|  |  |  <b>Outgoing calls</b>     |  |         |  |                                       |
|  |  |  <b>Contacts</b>           |  |         |  |                                       |
|  |  |  <b>Magnifying glass</b>   |  View       |         |  |                                       |
|  |  |   |  Create     |         |  |                                       |
|  <b>Call</b>  |  |   |  |         |  |                                       |
| <br> | <b>Telephone</b><br>↓<br><b>Contacts</b> |  <b>Addresses</b>          |  |         |  | After making choices, start the call. |
|  |  |  <b>View</b>               |  Create     |         |  |                                       |
|  |  |   |  Modify     |         |  |                                       |
|  |  |   |  Delete     |         |  |                                       |
|  |  |   |  Delete all |         |  |                                       |
|  |  |   |  By name    |         |  |                                       |
|  |  |   |  Confirm    |         |  |                                       |
|  |  |  <b>Navigate to</b>        |  |         |  |                                       |
|  |  |  <b>Search for contact</b> |  |         |  |                                       |
|  <b>Call</b>  |  |   |  |         |  |                                       |



| Level 1   |  | Level 2  |                  | Level 3   |  | Comments   |
|---|--|--|------------------|---|--|--|
| <br><br> | Telephone connection<br>↓<br>Secondary page<br>↓<br>Bluetooth connection |  Search       |                  |   |  | Start the search for another peripheral device to connect.   |
|   |  |  Disconnect   |                  |   |  | Stop the Bluetooth connection to the selected peripheral device.   |
|   |  |  Update       |                  |   |  | Import the contacts from the selected telephone to store them in the audio system.                           |
|   |  |  Delete       |                  |   |  | Delete the selected telephone.   |
|   |  |  Confirm      |                  |   |  | Save the settings.   |
| <br><br> | Telephone connection<br>↓<br>Secondary page<br>↓<br>Search for devices   |  |                  | <input checked="" type="checkbox"/> Telephone       |  | Start the search for peripheral devices.   |
|   |  |  | Devices detected | <input checked="" type="checkbox"/> Audio streaming |  |  |
|   |  |  |                  | <input checked="" type="checkbox"/> Internet        |  |  |
| <br><br> | Telephone connection<br>↓<br>Secondary page<br>↓<br>Telephone Options    |  Put on hold  |                  |   |  | Cut the microphone temporarily so that the contact cannot hear your conversation with a passenger.           |
|   |  |  Update       |                  |   |  | Import the contacts from the selected telephone to save them in the audio system.                            |
|   |  |  Ringtones    |                  |   |  | Choose the telephone ringtone and volume.  |
|   |  |  Memory info. |                  |   |  | Contact records used and free, percentage of storage space used by internal contacts and Bluetooth contacts. |
|   |  |  Confirm      |                  |   |  | Save the settings.   |

## Pairing a Bluetooth® telephone

**!** For reasons of safety and because they require prolonged attention on the part of the driver, the operations for pairing the Bluetooth mobile telephone to the hands-free system of the audio system must be carried out with the **vehicle stationary**.

### Procedure (short) from the telephone

In the Bluetooth menu of your device, select the system name in the list of devices detected.

Enter a code of at least 4 figures in the device and confirm.

**✓** Enter this same code in the system, select **"OK"** and confirm.

### Procedure from the system

Activate the telephone's Bluetooth function and ensure that it is "visible to all" (telephone configuration).



Press on **Telephone** to display the primary page.



Press on the secondary page.



Select **"Bluetooth connection"**.



Select **"Search for devices"**.  
The list of telephones detected is displayed.

**i** If the telephone is not detected, it is recommended that you switch the Bluetooth function on your telephone off and then on again.

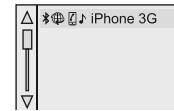

Select the name of the desired peripheral from the list and **"Confirm"**.



Enter a code of at least 4 figures for the connection then **"Confirm"**.

Enter this same code in the telephone then accept the connection.

The system offers to connect the telephone:

- in **"Telephone"** (hands-free kit, telephone only),
- in **"Audio streaming"** (streaming: wireless playing of audio files from the telephone),
- in **"Internet"** (internet browsing, only if your telephone is compatible with the "DUN" Dial-Up Networking Bluetooth standard).

Select one or more profiles and confirm.

**!** The services available depend on the network, the SIM card and the compatibility of the Bluetooth telephone used. Check the telephone manual and with your network provider for details of the services available to you.

**!** The ability of the system to connect with only one profile depends on the telephone. The three profiles may all connect by default.

Visit [www.peugeot.co.uk](http://www.peugeot.co.uk) for more information (compatibility, additional help, ...).

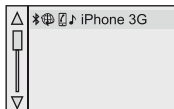

The recognised telephone appears in the list.

Depending on your telephone, you may be asked to accept automatic connection every time the ignition is switched on.

**!** Depending on the type of telephone, the system will ask you to accept or not the transfer of your contacts.



If not, select "**Update**".

On return to the vehicle, if the last telephone connected is present again, it is reconnected automatically and within around 30 seconds after switching on the ignition the pairing is done without any action on your part, with (Bluetooth activated).

To modify the automatic connection mode, select the telephone in the list then select the desired profile.

## Connecting a Bluetooth® peripheral device

### Automatic reconnection

On switching on the ignition, the telephone connected when the ignition was last switched off is automatically reconnected, if this connection mode had been activated during the pairing procedure.

The connection is confirmed by the display of a message and the name of the telephone.

### Manual connection



Press on **Telephone** to display the primary page.



Press on the secondary page.



Select "**Bluetooth**" to display the list of paired peripherals.

Select the peripheral to connect.



Press on "**Search for devices**".

The connection is confirmed by the display of a message and the name of the telephone.

## Managing paired telephones

**i** This function allows the connection or disconnection of a peripheral device as well as the deletion of a pairing.



Press on **Telephone** to display the primary page.



Press on the secondary page.



Select "**Bluetooth**" to display the list of paired peripheral devices.

Select the peripheral in the list.



Select "**Search for devices**"

Or



"**Connect / Disconnect**" to start or end the Bluetooth connection with the selected device.

Or



"**Delete**" to delete the pairing.

## Receiving a call

An incoming call is announced by a ring and a superimposed display in the screen.



Make a short press on the steering mounted **TEL** button to accept an incoming call.



Make a long press



on the steering mounted **TEL** button to reject the call.

Or



Select "**End call**".

## Making a call

**!** Using the telephone is not recommended while driving. Park the vehicle. Make the call using the steering mounted controls.

### Calling a new number



Press on **Telephone** to display the primary page.



Enter the phone number using the digital keypad. Press "**Call**" to start the call.

### Calling a contact



Press on **Telephone** to display the primary page.



Or make a long press



on the steering mounted **TEL** button.



Select "**Contacts**".

Select the desired contact from the list offered.



Select "**Call**".

## Calling a recently used number



Press on **Telephone** to display the primary page.



Select "**Call log**".

Select the desired contact from the list offered.



It is always possible to make a call directly from the telephone; park the vehicle first as a safety measure.

## Managing contacts / entries



Press on **Telephone** to display the primary page.



Select "**Contacts**".



Select "**View**".



Select "**Create**" to add a new contact.

Or



"**Modify**" to edit the selected contact.

Or



"**Delete**" to delete the selected contact.

Or



"**Delete all**" to delete all information for the selected contact.



Select "**By name**" to view the list of contacts.

## Frequently asked questions

The following table groups together the answers to the most frequently asked questions concerning your audio system.

### Navigation

| QUESTION  | ANSWER   | SOLUTION  |
|---|--|---|
| The route calculation is not successful.                              | The route settings may conflict with the current location (exclusion of toll roads on a toll motorway).  | Check the route settings in the "Navigation" menu.  |
| The POIs do not appear.   | The POIs have not been selected.   | Select the POIs in the list of POIs.  |
| The Risk areas audible warning does not work.                         | The audible warning is not active.   | Activate audible warnings in the "Navigation" menu.   |
| The system does not suggest a detour around an incident on the route. | The guidance criteria do not take account of TMC messages.   | Select the "Information" function in the list of route settings.  |
| I receive a Risk areas alert which is not on my route.                | Other than guidance, the system announces all Risk areas positioned in a cone located in front of the vehicle. It may provide an alert for Risk areas located on nearby or parallel roads. | Zoom in on the map to view the exact position of the Risk areas. Select "On the route" to no longer receive alerts other than navigation instructions or to reduce the time for the announcement. |



| QUESTION   | ANSWER  | SOLUTION  |
|--|---|---|
| Certain traffic jams along the route are not indicated in real time. | On starting, it is several minutes before the system begins to receive the traffic information.                               | Wait until the traffic information is being received correctly (display of the traffic information icons on the map). |
|  | The filters are too restrictive.  | Modify the settings.  |
|  | In certain countries, only major routes (motorways...) are listed for the traffic information.                                | This phenomenon is normal. The system is dependent on the traffic information available.                              |
| The altitude is not displayed.                                       | On starting, the initialisation of the GPS may take up to 3 minutes to receive more than 4 satellites correctly.              | Wait until the system has started up completely so that there is GPS coverage by at least 4 satellites.               |
|  | Depending on the geographical environment (tunnel...) or the weather, the conditions of reception of the GPS signal may vary. | This phenomenon is normal. The system is dependent on the GPS signal reception conditions.                            |

## Radio

| QUESTION  | ANSWER   | SOLUTION   |
|---|--|--|
| The quality of reception of the radio station listened to gradually deteriorates or the stored stations do not function (no sound, 87.5 Mhz is displayed...). | The vehicle is too far from the transmitter used by the station listened to or there is no transmitter in the geographical area through which the vehicle is travelling. | Activate the "RDS" function by means of the short-cut menu to enable the system to check whether there is a more powerful transmitter in the geographical area.  |
|   | The environment (hills, buildings, tunnels, basement car parks...) block reception, including in RDS mode.   | This phenomenon is normal and does not indicate a fault with the audio system.   |
|   | The aerial is absent or has been damaged (for example when going through a car wash or into an underground car park).  | Have the aerial checked by a PEUGEOT dealer.   |
| I cannot find some radio stations in the list of stations received.   | The station is not received or its name has changed in the list.   | Press and hold the "List" button at the steering mounted controls to update the list of stations received or press on the system update function: "Update list". |
| The name of the radio station changes.  | Some radio stations send other information in place of their name (the title of the song for example).   |  |
|   | The system interprets this information as the name of the station.   |  |

## Media

| QUESTION   | ANSWER  | SOLUTION   |
|--|---|--|
| Playback of my USB memory stick starts only after a very long wait (around 2 to 3 minutes).                        | Some files supplied with the memory stick may greatly slow down access to reading the memory stick (multiplication by 10 of the catalogue time).  | Delete the files supplied with the memory stick and limit the number of sub-folders in the file structure on the memory stick.   |
| When I connect my iPhone as a telephone and to the USB port at the same time, I am unable to play the music files. | When the iPhone connects automatically as a telephone, it forces the streaming function. The streaming function takes the place of the USB function which is then not useable, there is a period without sound of the track being played with Apple® players. | Disconnect and reconnect to the USB port (the USB function takes priority over streaming).   |
| The CD is ejected automatically or is not played by the player.  | The CD is inserted upside down, is unplayable, does not contain any audio data or contains an audio format which the player cannot play.  | Check that the CD is inserted in the player the right way up.<br>Check the condition of the CD: the CD cannot be played if it is too badly damaged.<br>Check the content in the case of a recorded CD: refer to the advice in the "AUDIO" section.<br>The audio system's CD player does not play DVDs.<br>Some recorded CDs will not be played by the audio system because they are not of adequate quality. |
|  | The CD has been recorded in a format that is not compatible with the player (udf...).   |  |
|  | The CD is protected by an anti-pirating protection system which is not recognised by the audio system.  |  |
| There is a long waiting period following the insertion of a CD or connection of a USB memory stick.                | When a new medium is inserted, the system reads a certain amount of data (directory, title, artist, etc.). This may take from a few seconds to a few minutes.   | This phenomenon is normal.   |

| QUESTION   | ANSWER   | SOLUTION  |
|--|--|---|
| The CD player sound is poor.   | The CD used is scratched or of poor quality.                           | Insert good quality CDs and store them in suitable conditions.    |
|  | The audio equipment settings (bass, treble, ambiences) are unsuitable. | Set the treble or bass level to 0, without selecting an ambience. |
| Some characters in the media information are not displayed correctly while playing.            | The audio system does not display some types of characters.            | Use standard characters to name tracks and folders.               |
| Playing of streaming files does not start.   | The peripheral device connected does not support automatic play.       | Start the playback from the device.                               |
| The names of tracks and the track length are not displayed on the screen when streaming audio. | The Bluetooth profile does not allow the transfer of this information. |   |

## Settings

| QUESTION  | ANSWER   | SOLUTION  |
|---|--|---|
| In changing the setting of treble and bass the equalizer setting is deselected. | The selection of an equalizer setting imposes the balance settings. Modifying one without the other is not possible.   | Modify the balance or equalizer settings to obtain the desired musical ambience.    |
| In changing the equalizer setting, treble and bass return to zero.              |  |   |
| When changing the balance settings, the distribution setting is deselected.     | The selection of a distribution setting imposes the balance settings. Modifying one without the other is not possible. | Modify the balance or distribution settings to obtain the desired musical ambience. |
| When changing an distribution setting, the balance setting is deselected.       |  |   |

| QUESTION  | ANSWER   | SOLUTION   |
|---|--|--|
| There is a difference in sound quality between the different audio sources. | For optimum sound quality, the audio settings for Loudness, Ambience, Treble, Bass, Volume can be adapted to the different sound sources, which may result in audible differences when changing source.  | Check that the audio settings (Loudness, Ambience, Treble, Bass, Volume) are adapted to the sources listened to. Adjust Balance, Treble and Bass to the middle position, select the "None" musical ambience and set the loudness correction to the "Active" position in CD mode or to the "Inactive" position in radio mode. |
| With the engine off, the system switches off after a few minutes of use.    | When the engine is switched off, the system's operating time depends on the state of charge of the battery.<br>The switch-off is normal: the system switches to economy mode and switches off to prevent discharging of the vehicle's battery. | Start the vehicle's engine to increase the battery charge.   |

## Telephone

| QUESTION  | ANSWER   | SOLUTION   |
|---|--|--|
| I cannot connect my Bluetooth telephone.                              | The telephone's Bluetooth function may be switched off or the telephone may not be visible.  | Check that your telephone's Bluetooth function is switched on.<br>Check in the telephone settings that it is "visible to all". |
|   | The Bluetooth telephone is not compatible with the system.   | You can check the compatibility of your telephone at <a href="http://www.peugeot.co.uk">www.peugeot.co.uk</a> (services).      |
| The volume of the telephone connected in Bluetooth mode is inaudible. | The volume depends both on the system and on the telephone.  | Increase the volume of the audio system, to maximum if required, and increase the volume of the telephone if necessary.        |
|   | The ambient noise level has an influence on the quality of telephone communication.  | Reduce the ambient noise level (close the windows, reduce the booster fan speed, slow down...).                                |
| Some contacts are duplicated in the list.                             | The options for synchronizing contacts are synchronizing the contacts on the SIM card, the contacts on the telephone, or both. When both synchronizations are selected, some contacts may be duplicated. | Select "Display SIM card contacts" or "Display telephone contacts".  |
| Contacts are not shown in alphabetical order.                         | Some telephones offer display options. Depending on the settings chosen, contacts can be transferred in a specific order.  | Modify the display setting in the telephone directory.   |
| The system does not receive SMS text messages.                        | The Bluetooth mode does not permit sending SMS text messages to the system.  |  |

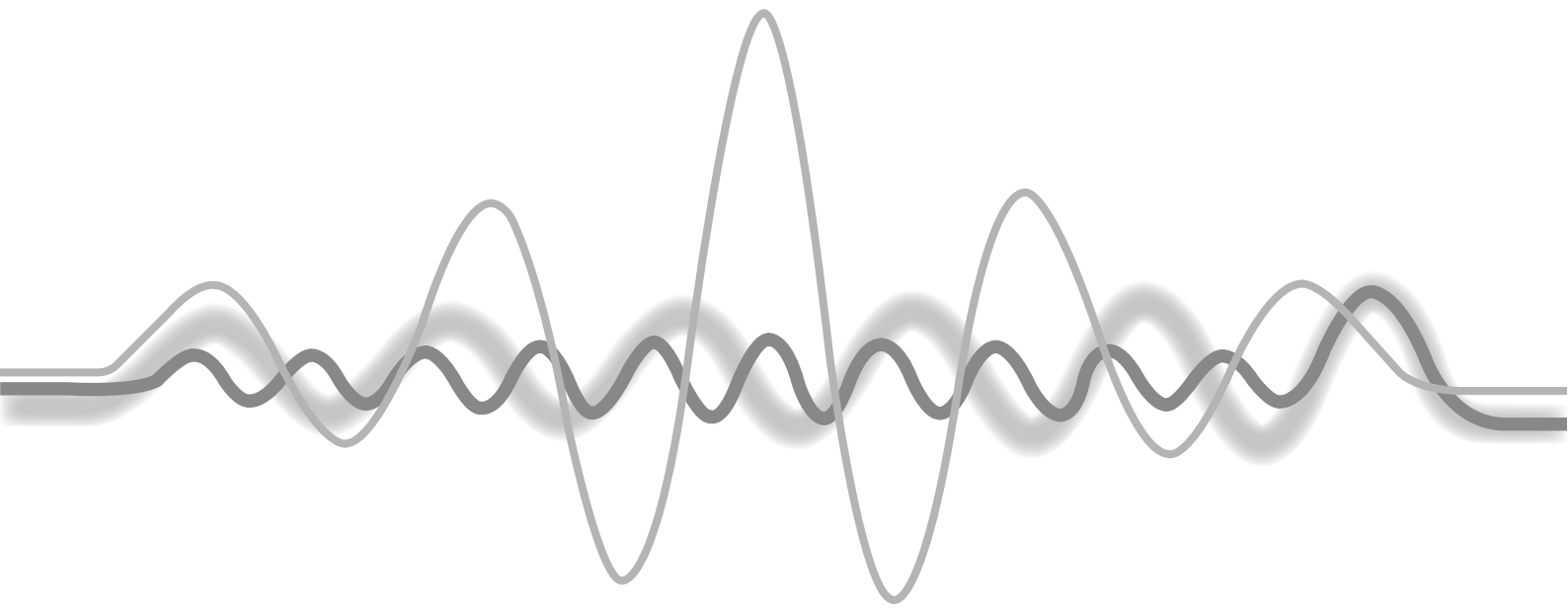



# PEUGEOT Connect Sound (RD5)

## Audio system / Bluetooth®

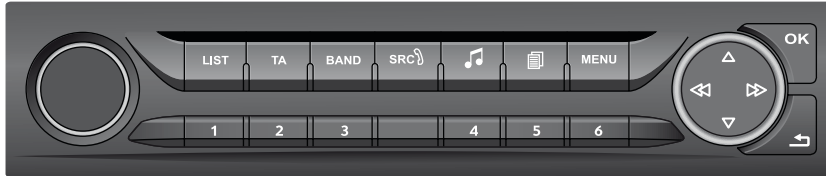

|  | Contents |
|--|----------|
| First steps                            | 360      |
| Steering mounted controls              | 361      |
| Menus                                  | 362      |
| Radio                                  | 362      |
| DAB (Digital Audio Broadcasting) radio | 364      |
| Media                                  | 366      |
| Telephone                              | 370      |
| Screen menu map(s)                     | 372      |
| Frequently asked questions             | 375      |

**i** Your PEUGEOT Connect Sound (RD5) is coded in such a way that it will only operate in your vehicle.

**!** As a safety measure, the driver must only carry out operations which require prolonged attention while the vehicle is stationary. When the engine is switched off and to prevent discharging of the battery, the audio equipment may switch off after a few minutes.

# First steps

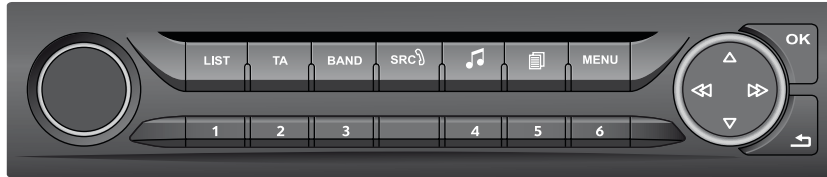

On/off, volume setting.

**LIST**

Display the list of local stations.  
Long press: CD tracks or MP3 folders (CD / USB).

**TA**

TA (Traffic Announcements) on/off.

**BAND**

Select wavebands FM, DAB and AM.

**SRC**

Select source:  
Radio; audio CD / MP3 CD; USB;  
Jack connection; Streaming; AUX.



Audio settings: front/rear fader, left/right balance, bass/treble, loudness, audio ambiances.



Select the screen display mode:  
date, audio functions, telephone, Bluetooth, personalisation-configuration.

**MENU**

Display main menu.

**1**

Buttons 1 to 6:  
Select a pre-set radio station.  
Long press: pre-set a station.



Automatic frequency search down/up.  
Select previous/next CD, MP3 or USB track.



Select next frequency down/up.  
Select previous/next MP3 folder.  
Select previous/next folder / genre / artist / playlist (USB).



Confirm.



Abandon the current operation.

# Steering mounted controls



Radio: select the previous/next pre-set station.  
 USB: select genre / artist / folder from the classification list.  
 Select the previous/next item in a menu.



Radio: automatic search for a higher frequency.  
 CD / MP3 / USB: select the next track.  
 CD / USB: continuous press: fast forward.  
 Move in the list.



Change audio source.  
 Confirm a selection.  
 Call/end call on the telephone.  
 Press for more than 2 seconds: telephone main menu.



Radio: automatic search for a lower frequency.  
 CD / MP3 / USB: select the previous track.  
 CD / USB: continuous press: rewind.  
 Move in the list.



Volume increase.



Volume decrease.



Mute: press the volume increase and decrease buttons simultaneously.  
 The sound is restored by pressing one of the two volume buttons.

# Menus

## Screen C

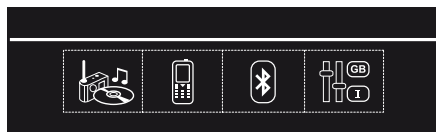

### Multimedia

Media parameters, Radio parameters.



### Telephone

Call, Directory management,  
Telephone management, Hang up.



### Bluetooth connection

Connections management, Search  
for a device.



### Personalisation-configuration

Define the vehicle parameters,  
Choice of language, Display  
configuration, Choice of units, Date  
and time adjustment.

## Screen A



**i** For a detailed global view of the menus available, refer to "Screen menu map" section.

# Radio

## Selecting a station



Press the **SRC** button repeatedly and select the radio.



Press the **BAND** button to select a waveband.



Briefly press one of the buttons to carry out an automatic search of the radio stations.



Press one of the buttons to carry out a manual search up / down for radio frequencies.



Press the **LIST** button to display the list of stations received locally (30 stations maximum).  
To update this list, press for more than two seconds.

## RDS

**i** The external environment (hills, buildings, tunnels, basement car parks, ...) may block reception, including in RDS mode. This is a normal effect of the way in which radio waves are transmitted and does not indicate any failure of the audio system.

**MENU**

Press the **MENU** button.



Select "**Audio functions**".

**OK**

Press **OK**.



Select the "**FM waveband preferences**" function.

**OK**

Press **OK**.



Select "**Activate RDS**".

**OK**

Press **OK**, RDS is displayed in the screen.

In "**Radio**" mode, press **OK** directly to activate / deactivate RDS mode.



RDS, if displayed, enables you to continue listening to the same station by automatic retuning to alternative frequencies. However, in certain conditions, coverage of an RDS station may not be assured throughout the country as radio stations do not cover 100 % of the territory. This explains the loss of reception of a station that can occur during a journey.

## Receiving TA messages



The TA (Traffic Announcement) function gives priority to TA alert messages. To operate, this function needs good reception of a radio station transmitting this type of message. When a traffic report is transmitted, the current audio source (Radio, CD, ...) is interrupted automatically to play the TA message. Normal playback of the audio source resumes at the end of the transmission of the message.

**TA**

Press the **TA** button to activate or deactivate traffic messages.

# DAB (Digital Audio Broadcasting) radio

Display options:

if active but not available, the display will be struck out.



If the "DAB" station being listened to is not available on "FM", "DAB FM" is struck out.



Display the name of the current station.

Preset stations, buttons 1 to 6.  
Short press: select the preset radio station.  
Long press: preset a radio station.

Display the name of the multiplex service being used.

Represents the signal strength for the band being listened to.

Display of RadioText (TXT) for the current radio station.

## Digital radio

**i** Digital radio provides a superior audio quality and also additional categories of traffic announcements (TA INFO). The different "multiplex services" offer a choice of radio stations in alphabetical order.

Change band (FM1, FM2, DAB, ...)

**BAND**



Change of station within the same "multiplex service".



Start a search for the next "multiplex service".

**TA**

Long press: select the desired categories of announcements from Transport, News, Entertainment and Flash special (availability according to the station).

**i** When the radio station is displayed in the screen, press on "**OK**" to display the contextual menu. (Frequency hopping (RDS), DAB / FM auto tracking, RadioText (TXT) display, Information on the station, ...)

## DAB / FM tracking

**i** "DAB" does not have 100% coverage of the country. When the digital signal is weak, "DAB / FM auto tracking" allows you to continue listening to the same station, by automatically switching to the corresponding analogue "FM" station (if it exists).

**MENU**

Press the "**Menu**" button.



Select "**Multimedia**" and confirm.



Select "**DAB / FM auto tracking**" and confirm

**i** If "DAB / FM auto tracking" is on, there will be a difference of a few seconds in the programme when the system changes to analogue "FM" radio, with sometimes a variation in volume. When the strength of the digital signal is good again, the system automatically switches back to "DAB".

**!** If the "DAB" station you are listening to is not available on "FM" ("**DAB/FM**" option barred), or if "DAB / FM auto tracking" is not on, the sound will be cut when the digital signal is too weak.

# Media

## USB player

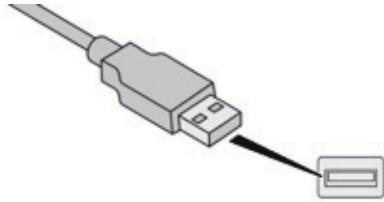

Insert a USB memory stick into the USB port or connect a USB peripheral device to the USB port using a suitable cable (not supplied).

**!** To protect the system, do not use a USB hub.

The system builds playlists (temporary memory), which can take from a few seconds to several minutes on the first connection. Reducing the number of non-music files and the number of folders reduces this waiting time. Playlists are updated every time the ignition is switched off or a USB memory stick is connected. The lists are memorised: if the lists are not changed, the subsequent loading time is reduced.

**LIST**

Press and hold **LIST** to display the different classifications.



Select by "**Folder**" / "**Artist**" / "**Genre**" / "**Playlist**".

**OK**

Press **OK** to select the classification required, then press **OK** again to confirm.

**LIST**

Press **LIST** briefly to display the previously selected classification.



Navigate through the list using the left/right and up/down buttons.

**OK**

Confirm the selection by pressing **OK**.



Press one of these buttons to gain access to the previous / next track in the list.

Press and hold one of the buttons for fast forward or rewind.



Press one of these buttons to gain access to the previous / next "**Folder**" / "**Artist**" / "**Genre**" / "**Playlist**" in the list.



## Auxiliary socket (AUX)



Connect the portable device (MP3 player, ...) to the auxiliary Jack socket using an audio cable (not supplied).

Press the **SOURCE** button several times in succession and select **AUX**.

First adjust the volume on your portable device (to a high level). Then adjust the volume on your audio system. Operation of controls is via the portable device.

**!** Do not connect a device to both the Jack auxiliary socket and the USB port at the same time.

## CD player

Insert circular compact discs only. Some anti-pirating systems, on original discs or CDs copied using a personal recorder, may cause faults which are no reflection on the quality of the vehicle's player. Insert a CD in the player, play begins automatically.

**SRC** 

To play a disc which has already been inserted, press the **SOURCE** button several times in succession and select **CD**.



Press one of the buttons to select a track on the CD.

**LIST**

Press the **LIST REFRESH** button to display the list of tracks on the CD.



Press and hold one of the buttons for fast forward or rewind.

## Playing an MP3 CD compilation

Insert an MP3 compilation in the CD player. The audio equipment searches for all of the music tracks, which may take anything between a few seconds and several tens of seconds, before play begins.

**!** On a single disc, the CD player can read up to 255 MP3 files spread over 8 folder levels. However, it is advisable to keep to a limit of two levels to reduce the access time before the CD is played. While the CD is being played, the folder structure is not followed. All of the files are displayed on a single level.

**SRC** / 

To play a disc which has already been inserted, press the **SOURCE** button several times in succession and select "**CD**".



Press one of the buttons to select a folder on the CD.



Press one of the buttons to select a track on the CD.

**LIST**

Press the **LIST** button to display the list of directories of the MP3 compilation.



Press and hold one of the buttons for fast forward or backward play.

## Information and advice

The audio system will only play files with the extension ".mp3" with a sampling rate of 22.05 KHz or 44.1 KHz. No other type of file (.wma, .mp4, .m3u, etc.) can be played.

It is advisable to restrict file names to 20 characters without using special characters (e.g. " ? ; ù) to avoid any playing or displaying problems.

In order to be able to play a recorded CDR or CDRW, when recording, the ISO 9660 level 1.2 or Joliet file format is recommended.

If the disc is recorded in another format, it may not be played correctly.

It is recommended that the same recording format is always used for an individual disc, with as low a speed as possible (4x maximum) for optimum sound quality.

In the particular case of a multi-session CD, the Joliet format is recommended.

Use only USB memory sticks formatted FAT32 (File Allocation Table).

**!** To protect the system, do not use a USB hub.

**i** It is recommended that you use genuine Apple® USB cables for correct operation.

## Bluetooth® audio streaming

Streaming allows music files on the telephone to be played via the audio system.

Connect the telephone: see the "**Telephone**" section.

Select in the "**Bluetooth: Telephone - Audio**" menu the telephone to be connected. The audio system connects to a newly paired telephone automatically.

**SRC /** Activate the streaming source by pressing the **SOURCE\*** button.

Control of tracks to be played is via the buttons on the audio system control panel and the steering mounted controls\*\*. The contextual information can be displayed in the screen.

\* In certain cases, play of the audio files must be initiated from the keypad.

\*\* If the telephone supports the function.

## Connecting Apple® players

Connect the Apple® player to the USB port using a suitable cable (not supplied). Play starts automatically.

Control is via the audio system.

The classifications available are those of the portable device connected (artists / albums / genres / playlists / audiobooks / podcasts).

The version of software in the audio system may not be compatible with the generation of your Apple® player.

# Telephone

## Pairing a Bluetooth® telephone

### Screen C

(Available according to model and version)

**!** As a safety measure and because they require prolonged attention on the part of the driver, the operations for pairing of the Bluetooth mobile telephone with the Bluetooth hands-free system of your audio equipment must be carried out with the vehicle stationary and the ignition on.

Go to [www.peugeot.co.uk](http://www.peugeot.co.uk) for more information (compatibility, more help, ...).

Activate the telephone's Bluetooth function and ensure that it is "visible to all" (telephone configuration).

**MENU**

Press the **MENU** button.



In the menu, select:

- "Bluetooth: Telephone - Audio"
- "Bluetooth configuration"
- "Perform a Bluetooth search"

A window is displayed with a message that a search is in progress.



The services available depend on the network, the SIM card and the compatibility of the Bluetooth device used. Consult your telephone's manual and your operator to find out which services are available to you.

The first 4 telephones recognised are displayed in this window.

The "**Telephone**" menu permits access to the following functions in particular: "**Directory**", "**Calls list**", "**Consult the paired equipment**".

Select the telephone to be connected from the list. Only one telephone can be connected at a time.



A virtual keypad is displayed in the screen: enter a code with at least 4 digits.

**OK**

Confirm by pressing **OK**.

A message in the screen indicates the telephone chosen. To accept the pairing, enter the same code on the telephone, then confirm with **OK**. If pairing fails, the number of attempts is not limited.

A message that the pairing has been successful appears in the screen.

The automatic connection authorised is only active after the telephone has been configured. The directory and the call list can be accessed after the necessary synchronisation period.

\* If your telephone is fully compatible.

## Receiving a call

An incoming call is announced by a ring and a superimposed display in the screen.



Select the **YES** tab on the display using the buttons.

**OK**

Confirm by pressing **OK**.



Press this button at the steering mounted controls to accept the call.

## Making a call

From the "**Bluetooth: Telephone - Audio**" menu.

Select "**Manage the telephone call**".

Select "**Call**".

Or

Select "**Calls list**".

Or

Select "**Directory**".



Press this button for more than two seconds for access to your directory, then navigate using the thumbwheel.

Or

To dial a number, use your telephone's keypad, with the vehicle stationary.

## Ending a call



During a call, press this button for more than 2 seconds.

Confirm with **OK** to end the call.



The system accesses the telephone's contacts directory, depending on its compatibility, and while it is connected by Bluetooth.



With certain telephones connected by Bluetooth you can send a contact to the directory of the audio system. Contacts imported in this way are saved in a permanent directory visible to all, whatever the telephone connected.

The menu for the directory is not accessible if it is empty.

# Screen menu map(s)

## Screen A

### Radio-CD

- 1
- 2 RDS options
- 2 REG mode
- 2 CD repeat
- 2 Shuffle play

### Vehicle config\*

- 1
- 2 R wiper in rev
- 2 Guide lighting

### Options

- 1
- 2 Diagnostic
- 3 View
- 3 Abandon

### Units

- 1
- 2 Temperature: °Celsius / °Fahrenheit
- 2 Fuel consumption: KM/L - L/100 - MPG
- 2

### Display adjust

- 1
- 2 Year
- 2 Month
- 2 Day
- 2 Hour
- 2 Minutes
- 2 12 H/24 H mode

### Language

- 1
- 2 Français
- 2 Italiano
- 2 Nederlands
- 2 Português
- 2 Português do Brasil
- 2 Deutsch
- 2 English
- 2 Español
- 2 Čeština
- 2 Hrvatski
- 2 Magyar

\* The settings vary according to the trim level of the vehicle.

## Screen C

### MEDIA

- 1 **Media parameters**
- 2 **Choice of playback mode**
  - 3 Normal
  - 3 Random
  - 3 Random all
  - 3 Repeat
- 2 **Choice of track listing**
  - 3 By folders
  - 3 By artists
  - 3 By genres
  - 3 By playlists
- 1 **Radio parameters**

### TELEPHONE

- 1 **Call**
  - 2 Dial
  - 2 Directory
  - 2 Calls list
  - 2 Voice mail box
- 1 **Directory management**
  - 2 Consult an entry
  - 2 Delete an entry
  - 2 Delete all entries
- 1 **Telephone management**
  - 2 Telephone status
- 1 **Hang up**

### BLUETOOTH CONNECTION

- 1 **Connections management**
  - 1 Search for a device

## **PERSONALISATION - CONFIGURATION**

**1** Define the vehicle  
parameters\*

**1** Choice of language

**1** Display configuration

**2** Choice of units

**2** Date and time adjustment

**2** Display parameters

**2** Brightness

**1** Choice of sounds

\* Depending on vehicle equipment.



## Frequently asked questions

The table below gives answers to the most frequently asked questions on your audio system.

| QUESTION   | ANSWER  | SOLUTION   |
|--|---|--|
| With the engine off, the audio system switches off after a few minutes of use. | When the engine is switched off, the audio system operating time depends on the state of charge of the battery.<br>The switch-off is normal: the audio equipment switches to economy mode and switches off to prevent discharging of the vehicle's battery. | Start the vehicle's engine to increase the battery charge.                 |
| The message "the audio system is overheated" appears on the display.           | In order to protect the installation if the surrounding temperature is too high, the audio system switches to an automatic thermal protection mode leading to a reduction in volume or CD play stopping.  | Switch the audio system off for a few minutes to allow the system to cool. |

## Radio

| QUESTION   | ANSWER   | SOLUTION   |
|--|--|--|
| There is a difference in sound quality between the different audio sources (radio, CD...). | For optimum sound quality, the audio settings (Volume, Bass, Treble, Ambience, Loudness) can be adapted to the different sound sources, which may result in audible differences when changing source (radio, CD...). | Check that the audio settings (Volume, Bass, Treble, Ambience, Loudness) are adapted to the sources listened to. It is advisable to set the audio functions (Bass, Treble, Front-Rear Balance, Left-Right Balance) to the middle position, select the musical ambience "None" and set the loudness correction to the "Active" position in CD mode or to the "Inactive" position in radio mode. |

| QUESTION  | ANSWER   | SOLUTION   |
|---|--|--|
| The stored stations do not function (no sound, 87.5 Mhz is displayed...).   | An incorrect waveband is selected.   | Press the BAND AST button to return to the waveband (AM, FM1, FM2, FMAST) on which the stations are stored.                    |
| The traffic announcement (TA) is displayed. I do not receive any traffic information.   | The radio station is not part of the regional traffic information network.   | Tune to a radio station which broadcasts traffic information.  |
| The quality of reception of the radio station listened to gradually deteriorates or the stored stations do not function (no sound, 87.5 Mhz is displayed...). | The vehicle is too far from the transmitter used by the station listened to or there is no transmitter in the geographical area through which the vehicle is travelling. | Activate the RDS function to enable the system to check whether there is a more powerful transmitter in the geographical area. |
|   | The environment (hills, buildings, tunnels, underground car parks...) block reception, including in RDS mode.  | This phenomenon is normal and does not indicate a failure of the audio equipment.  |
|   | The aerial is absent or has been damaged (for example when going through an automatic car wash or into an underground car park).   | Have the aerial checked by a PEUGEOT dealer.   |
| Sound cut-outs of 1 to 2 seconds in radio mode.   | During this brief sound cut-out, the RDS searches for another frequency giving better reception of the station.  | Deactivate the RDS function if the phenomenon is too frequent and always on the same route.                                    |

## Media

| QUESTION   | ANSWER  | SOLUTION  |
|--|---|---|
| <p>The message "USB peripheral error" is displayed on the screen. The Bluetooth connection is cut.</p> | <p>The battery of the peripheral may not be sufficiently charged.</p>   | <p>Recharge the battery of the peripheral device.</p>   |
|  | <p>The USB memory stick is not recognised.<br/>The USB memory stick may be corrupt.</p>   | <p>Reformat the USB memory stick.</p>   |
| <p>The CD is ejected automatically or is not played by the player.</p>                                 | <p>The CD is inserted upside down, is unplayable, does not contain any audio data or contains an audio format which the player cannot play. The CD is protected by an anti-pirating protection system which is not recognised by the audio equipment.</p> | <ul style="list-style-type: none"> <li>- Check that the CD is inserted in the player the right way up.</li> <li>- Check the condition of the CD: the CD cannot be played if it is too damaged.</li> <li>- Check the content in the case of a recorded CD: consult the advice in the "Audio" section.</li> <li>- The audio equipment's CD player does not play DVDs.</li> <li>- Due to their quality level, certain writeable CDs will not be played by the audio system.</li> </ul> |
| <p>The CD player sound is poor.</p>  | <p>The CD used is scratched or of poor quality.</p>   | <p>Insert good quality CDs and store them in suitable conditions.</p>   |
|  | <p>The audio equipment settings (bass, treble, ambiances) are unsuitable.</p>   | <p>Set the treble or bass level to 0, without selecting an ambience.</p>  |

## Telephone

| QUESTION                            | ANSWER  | SOLUTION |
|-------------------------------------|---|----------|
| I am unable to access my voicemail. | Few telephones or service providers allow the use of this function. |          |

## A

ABS ..... 121  
 Accessories ..... 152, 220, 222  
 AdBlue® additive ..... 26, 32, 233-237  
 Additive, Diesel ..... 230  
 Adjusting headlamps ..... 113  
 Adjusting head restraints ..... 77  
 Adjusting the air distribution ..... 95  
 Adjusting the air flow ..... 95  
 Adjusting the date ..... 47-49  
 Adjusting the height and reach of  
   the steering wheel ..... 72  
 Adjusting the lumbar support ..... 73  
 Adjusting the seat ..... 73  
 Adjusting the temperature ..... 95  
 Adjusting the time ..... 47-49  
 Advice on driving ..... 146, 147  
 Affaire version ..... 291  
 Airbags ..... 23, 127, 134  
 Airbags, curtain ..... 129, 130  
 Airbags, front ..... 127, 130  
 Airbags, lateral ..... 129, 130  
 Air conditioning ..... 10, 93, 95, 98  
 Air conditioning, automatic ..... 92, 95  
 Air conditioning, digital ..... 100  
 Air conditioning, manual ..... 92-94, 100  
 Air intake ..... 99  
 Air vents ..... 91  
 Alarm ..... 67  
 Anti-lock braking system (ABS) ..... 121  
 Anti-pinch ..... 70, 102  
 Anti-theft ..... 53, 154  
 Anti-slip regulation (ASR) ..... 121  
 Armrest ..... 82  
 Armrest, front ..... 84  
 Armrest, rear ..... 86  
 Assistance call ..... 119  
 Audible warning ..... 121  
 Audio streaming (Bluetooth) ..... 312, 314, 369  
 Auxiliary ..... 312

## B

Back-up key ..... 63  
 Battery ..... 219, 231, 268-271  
 Battery, charging ..... 270  
 Battery, remote control ..... 54, 55, 64, 65  
 Bicycle carrier ..... 222  
 Blanking screen  
   (snow shield) ..... 217, 218  
 Blind, panoramic roof ..... 102  
 Blind spot sensors ..... 16, 195  
 BlueHDi ..... 28, 32, 233, 274  
 Bluetooth (hands-free) ..... 346, 347, 370  
 Bluetooth (telephone) ..... 346, 347  
 Bonnet ..... 225  
 Boot ..... 61  
 Boot lamp ..... 88  
 Brake discs ..... 232  
 Brake lamps ..... 257, 259  
 Brakes ..... 21, 25, 232  
 Bulbs (changing) ..... 252, 257, 259

## C

Cable, audio ..... 312  
 Cable, jack ..... 312  
 Capacity, fuel tank ..... 213  
 Cap, fuel filler ..... 213  
 CD, MP3 ..... 312, 367, 368  
 Central locking ..... 51, 56, 58, 59  
 Changing a bulb ..... 252, 257, 259  
 Changing a fuse ..... 262, 264, 266  
 Changing a wheel ..... 246, 247

Changing a wiper blade ..... 117, 222  
 Changing the remote  
   control battery ..... 54, 64  
 Checking the engine oil level ..... 31  
 Checking the levels ..... 228-230  
 Checking tyre pressures  
   (using the kit) ..... 239  
 Checks ..... 226, 227, 231, 232  
 Child lock ..... 63, 144  
 Children ..... 138, 142, 143  
 Children (safety) ..... 144  
 Child  
   seats ..... 126, 131-133, 137, 138, 145  
 Child seats, conventional ..... 137  
 Child seats, ISOFIX ..... 140, 142, 143  
 Closing the boot ..... 61  
 Closing the doors ..... 51, 56, 58, 59  
 Collision risk alert ..... 190  
 Compressor, tyre inflation ..... 239  
 Configuration, vehicle ..... 44  
 Connection, Bluetooth ..... 346, 347  
 Control, electric windows ..... 70  
 Control, emergency boot  
   release ..... 62  
 Control, emergency door ..... 63  
 Control, heated seats ..... 76  
 Control stalk, lighting ..... 14, 107  
 Control stalk, wipers ..... 114-116  
 Courtesy lamps ..... 103  
 Cruise control ..... 173, 177, 180, 181  
 Cruise control, dynamic ..... 180  
 Cup holder ..... 82

## D

|  |                              |
|--|------------------------------|
| DAB (Digital Audio Broadcasting) -     |                              |
| Digital radio.....                     | 310, 311, 364, 365           |
| Date (setting).....                    | 47-49                        |
| Daytime running                        |                              |
| lamps .....                            | 108, 110, 252, 253, 255, 256 |
| Deactivating the passenger airbag..... | 127, 134                     |
| Deactivation of DSC (ESC).....         | 123                          |
| Deadlocking .....                      | 52, 60                       |
| Defrosting.....                        | 93, 100, 101                 |
| Demisting .....                        | 93, 100                      |
| Demisting, rear screen .....           | 101, 105                     |
| Denon (audio system).....              | 89, 293                      |
| Dimensions .....                       | 289                          |
| Dipstick.....                          | 31, 228                      |
| Direction indicators .....             | 112, 252, 255, 257, 259      |
| Display of inter-vehicle time.....     | 187                          |
| Display screen, instrument panel ..... | 164                          |
| Display screen, multifunction          |                              |
| (with audio system).....               | 49                           |
| Display screen, multifunction          |                              |
| (without audio system).....            | 49                           |
| Driver Sport Pack.....                 | 169                          |
| Driving abroad.....                    | 107                          |
| Driving economically.....              | 10                           |
| Dynamic pack (sport).....              | 169                          |
| Dynamic stability control (DSC)....    | 17, 21, 121, 123             |

|   |                             |
|---|-----------------------------|
| Electronic brake force distribution     |                             |
| (EBFD).....                             | 121                         |
| Electronic stability control (ESC)..... | 17, 121                     |
| Emergency call .....                    | 119                         |
| Emergency braking assistance            |                             |
| (EBA).....                              | 121                         |
| Emergency collision braking.....        | 22, 190, 193                |
| Emergency switching off.....            | 152                         |
| Emergency warning lamps .....           | 118, 238                    |
| Emissions control system, SCR .....     | 27                          |
| Energy economy mode.....                | 219                         |
| Engine compartment .....                | 226, 227                    |
| Engine, Diesel.....                     | 15, 215, 227, 274, 281, 285 |
| Engine, petrol.....                     | 215, 226, 275               |
| Engines .....                           | 275, 281, 285               |
| Environment.....                        | 10, 55, 64                  |

|                                  |               |
|----------------------------------|---------------|
| Foglamps .....                   | 252           |
| Foglamps, front.....             | 109, 252, 256 |
| Foglamps, rear.....              | 109, 257, 259 |
| Folding the rear seats .....     | 80            |
| Frequency (radio).....           | 308, 309      |
| Fuel.....                        | 10, 215       |
| Fuel consumption.....            | 10            |
| Fuel tank.....                   | 22            |
| Fusebox, engine compartment..... | 266           |
| Fuses.....                       | 262, 264, 266 |

## G

|                                  |   |
|----------------------------------|---|
| Gauge, fuel.....                 | 213   |
| Gearbox, automatic .....         | 10, 12, 15, 151, 153, 162, 165, 169-171, 177, 181, 232, 268 |
| Gearbox, electronic .....        | 10  |
| Gearbox, manual .....            | 10, 12, 15, 162, 163, 170, 171, 177, 181, 232               |
| Gear lever .....                 | 10  |
| Gear lever,                      |   |
| automatic gearbox .....          | 165   |
| Gear lever, manual gearbox ..... | 163   |
| Gear shift indicator .....       | 164   |
| Glove box, refrigerated .....    | 82  |
| Guide-me-home.....               | 112   |

## F

|                                    |          |
|------------------------------------|----------|
| Filling the AdBlue® tank .....     | 237      |
| Filling the fuel tank.....         | 213, 215 |
| Filter, air .....                  | 231      |
| Filter, oil .....                  | 231      |
| Filter, particle .....             | 230, 231 |
| Filter, passenger compartment..... | 231      |
| Fitting a wheel.....               | 248      |
| Fitting roof bars.....             | 223      |
| Fittings, boot .....               | 87, 88   |
| Fittings, interior .....           | 82       |
| Flap, fuel filler.....             | 213      |
| Flashing indicators.....           | 112      |

## E

|                           |     |
|---------------------------|-----|
| Eco-driving (advice)..... | 10  |
| Economy mode .....        | 219 |

---

**H**

Hazard warning lamps ..... 118, 238  
 Headlamp adjustment ..... 113  
 Headlamps, automatic  
   illumination ..... 108, 111, 112  
 Headlamps, dipped beam ..... 107, 252, 254  
 Headlamps, halogen ..... 252, 254  
 Headlamps, main beam ..... 107, 252, 254, 256  
 Headlamp wash ..... 115  
 Head restraints, front ..... 77  
 Head restraints, rear ..... 80, 81  
 Heating ..... 10, 91, 93, 94  
 Hill start assist ..... 162  
 Horn ..... 121

---

**I**

Identification, vehicle ..... 292  
 Ignition ..... 98, 150, 152  
 Immobiliser, electronic ..... 53, 65, 154  
 Indicator, AdBlue® range ..... 32  
 Indicator, coolant temperature ..... 28  
 Indicator, engine oil level ..... 31  
 Indicator lamps, operation ..... 14, 15, 17, 20  
 Indicator lamps, status ..... 15, 20  
 Indicators, direction ..... 112  
 Inflating tyres ..... 10  
 Inflating tyres and accessories  
   (using the kit) ..... 239  
 Instrument panel ..... 12  
 Intelligent Traction Control ..... 122  
 Interactive help ..... 44, 337

Inter-vehicle time ..... 187  
 Isofix mountings ..... 140-144

---

**J**

Jack ..... 85, 246, 312

---

**K**

Key ..... 50, 51, 56, 58, 59, 64, 63, 65  
 Keyless Entry  
   and Starting ..... 58-60, 65, 151, 154  
 Key with remote  
   control ..... 51, 53, 59, 154  
 Kit, hands-free ..... 346, 347, 370  
 Kit, temporary puncture repair ..... 87, 239

---

**L**

Labels, identification ..... 292  
 Level, brake fluid ..... 229  
 Level, Diesel additive ..... 230, 231  
 Level, engine coolant ..... 28, 230  
 Level, engine oil ..... 31, 228  
 Level, headlamp wash ..... 116, 230  
 Levels and checks ..... 226-230  
 Level, screenwash fluid ..... 116, 230  
 Light-emitting diodes - LEDs ..... 252, 257, 259  
 Lighting ..... 14, 104, 107  
 Lighting dimmer ..... 36  
 Lighting, guide-me home ..... 53, 111, 112  
 Lighting, interior ..... 103, 104  
 Lighting, mood ..... 104  
 Lighting, welcome ..... 112  
 Loading ..... 10, 223  
 Load reduction mode ..... 219  
 Locating your vehicle ..... 53, 57  
 Locking ..... 65  
 Long objects, transporting ..... 86  
 Low fuel level ..... 22, 213  
 Luggage cover ..... 88, 89  
 Luggage retaining strap ..... 87, 88  
 Lumbar ..... 73, 78

---

**M**

Maintenance, routine ..... 10  
 Map reading lamps ..... 103  
 Markings, identification ..... 292  
 Massage function ..... 78

|                            |  |
|----------------------------|--|
| Mat .....                  | 83   |
| Memorising a speed .....   | 173  |
| Menu .....                 | 302, 304, 306, 316,<br>318, 322, 330, 342, 344 |
| Menu, main .....           | 362  |
| Menus (audio) .....        | 302, 304, 306,<br>316, 318, 342, 344           |
| Menus (Touch screen) ..... | 295, 300, 301                                  |
| Mirror, rear view .....    | 106  |
| Mirrors, door .....        | 101, 105, 195                                  |
| Misfuel prevention .....   | 214  |
| Mountings, Isofix .....    | 140, 141                                       |
| MP3 CD .....               | 368  |

|                          |                |
|--------------------------|----------------|
| Oil, engine .....        | 228            |
| Opening the bonnet ..... | 225            |
| Opening the boot .....   | 50, 56, 58, 61 |
| Opening the doors .....  | 50, 56, 58     |

|                           |  |
|---------------------------|--|
| Protecting children ..... | 127, 131-133, 138,<br>140, 142, 143, 145 |
| Puncture .....            | 239                                      |

## N

|                                |     |
|--------------------------------|-----|
| Navigation .....               | 322 |
| Net, high load retaining ..... | 90  |
| Number plate lamps .....       | 261 |

## O

|                       |     |
|-----------------------|-----|
| Oil change .....      | 228 |
| Oil consumption ..... | 228 |

## P

|                                      |                    |
|--------------------------------------|--------------------|
| Pads, brake .....                    | 232                |
| Paint colour code .....              | 292                |
| Panoramic glass sunroof .....        | 102                |
| Parcel shelf, rear .....             | 87                 |
| Park Assist .....                    | 201, 203, 206      |
| Parking brake .....                  | 15, 154, 232       |
| Parking brake, electric .....        | 20, 155, 160       |
| Parking sensors, front .....         | 198                |
| Parking sensors, rear .....          | 198                |
| PEUGEOT Connect Apps .....           | 341                |
| PEUGEOT Connect Assistance .....     | 119                |
| PEUGEOT Connect Packs .....          | 119                |
| PEUGEOT Connect SOS .....            | 119                |
| PEUGEOT Connect Sound<br>(RD5) ..... | 359                |
| Plates, identification .....         | 292                |
| Player, Apple® .....                 | 314, 369           |
| Player, MP3 CD .....                 | 312, 367, 368      |
| Player, USB .....                    | 312, 366           |
| Port, USB .....                      | 82, 85, 312, 366   |
| Pressures,<br>tyres .....            | 239, 245, 251, 292 |
| Pre-tensioning seat belts .....      | 126                |
| Priming pump .....                   | 274                |
| Priming the fuel system .....        | 274                |

## R

|   |                       |
|---|-----------------------|
| Radio .....   | 308, 309, 312, 362    |
| Radio, digital (Digital Audio<br>Broadcasting - DAB) .....        | 310, 311              |
| Range, AdBlue® .....  | 32                    |
| RDS .....   | 309                   |
| Rear screen, demisting .....                                      | 101                   |
| Recharging the battery .....                                      | 270                   |
| Recirculation, air .....  | 95, 99                |
| Reduction of electrical load .....                                | 219                   |
| Regeneration of the particle filter .....                         | 231                   |
| Reinitialisation of the under-inflation<br>detection system ..... | 210                   |
| Reinitialising the remote control .....                           | 54, 64                |
| Reminder, key in ignition .....                                   | 150                   |
| Remote control .....  | 50, 51, 56, 58-60, 65 |
| Removing a wheel .....  | 248                   |
| Removing the mat .....  | 83                    |
| Replacing bulbs .....   | 252, 257, 259         |
| Replacing fuses .....   | 262, 264              |
| Replacing the air filter .....                                    | 231                   |
| Replacing the oil filter .....                                    | 231                   |
| Replacing the passenger<br>compartment filter .....               | 231                   |
| Reservoir, headlamp wash .....                                    | 230                   |
| Reservoir, screenwash .....                                       | 230                   |
| Resetting the service indicator .....                             | 30                    |



|                                   |          |
|-----------------------------------|----------|
| Resetting the trip recorder.....  | 35       |
| Reversing camera.....             | 200      |
| Reversing lamp.....               | 257, 259 |
| Risk areas (update).....          | 327      |
| Roof bars.....                    | 223      |
| Running out of fuel (Diesel)..... | 274      |

## S

|  |   |
|--|---|
| Safety, children.....                                | 127, 131-133,<br>138, 142, 143, 145                     |
| Saturation of the particle filter<br>(Diesel).....   | 231   |
| Screen, cold climate.....                            | 217   |
| Screen, colour.....                                  | 300, 301  |
| Screen, instrument panel.....                        | 37  |
| Screen menu map.....                                 | 302, 304, 306, 316,<br>318, 322, 330, 342, 344, 372-374 |
| Screen, monochrome.....                              | 372   |
| Screen, monochrome A.....                            | 372   |
| Screen, multifunction<br>(with audio system).....    | 49, 362   |
| Screen, multifunction<br>(without audio system)..... | 49  |
| Screenwash.....                                      | 115   |
| SCR (Selective Catalytic<br>Reduction).....          | 233   |
| Seat belts.....                                      | 124-126, 137  |
| Seat, rear bench.....                                | 79, 80  |
| Seats, front.....                                    | 73  |
| Seats, heated.....                                   | 76  |
| Serial number, vehicle.....                          | 292   |

|  |   |
|--|---|
| Service indicator.....                   | 28  |
| Service (warning lamp).....              | 19  |
| Settings, equipment.....                 | 44  |
| Settings (Menus).....                    | 330   |
| Settings, system.....                    | 338   |
| Sidelamps.....                           | 107, 252, 253, 255-257, 259                               |
| Side repeater.....                       | 256   |
| Ski flap.....                            | 86  |
| Snow chains.....                         | 209, 216  |
| Socket, 12 V accessory.....              | 82, 84, 88  |
| Socket, auxiliary.....                   | 312, 367  |
| Socket, JACK.....                        | 82, 85, 312, 367  |
| Sockets, audio.....                      | 85  |
| Speed limiter.....                       | 173, 174  |
| Spotlamps, side.....                     | 113, 256  |
| Stability control (ESC).....             | 17, 121   |
| Starting the vehicle.....                | 148, 151, 152   |
| Starting using another battery.....      | 152   |
| Station, radio.....                      | 308, 309, 362   |
| Stay, bonnet.....                        | 225   |
| Steering mounted controls,<br>audio..... | 299, 361  |
| Steering wheel, adjustment.....          | 72  |
| Stop.....                                | 18  |
| Stopping the vehicle.....                | 151, 152, 165   |
| Stop & Start.....                        | 16, 25, 39, 92, 100, 170,<br>172, 213, 225, 231, 268, 271 |
| Stop (warning lamp).....                 | 18  |
| Storage.....                             | 82, 84, 86-88   |
| Storage wells.....                       | 87, 88  |
| Stowing rings.....                       | 87, 88  |
| Switching off the engine.....            | 148   |
| Synchronising the remote control.....    | 54, 64  |

|  |                                  |
|--|----------------------------------|
| Tables of engines.....                       | 275, 281, 285                    |
| Tables of fuses.....                         | 262, 264, 266                    |
| Tables of weights.....                       | 278, 285                         |
| Tank, fuel.....                              | 213                              |
| Technical data.....                          | 275, 278, 281, 285               |
| Telephone.....                               | 346-348, 370                     |
| Temperature, coolant.....                    | 228                              |
| Three flashes<br>(direction indicators)..... | 112                              |
| Time (setting).....                          | 47-49                            |
| TMC (Traffic info).....                      | 328                              |
| Tools.....                                   | 239, 246                         |
| Topping-up the AdBlue®<br>additive.....      | 235                              |
| Top Tether.....                              | 140                              |
| Total distance recorder.....                 | 35                               |
| Touch screen.....                            | 38, 40, 42, 44, 45, 47, 173, 211 |
| Touch screen (Menus).....                    | 295, 300, 301                    |
| Towbar.....                                  | 147, 218                         |
| Towed loads.....                             | 278, 285                         |
| Towing another vehicle.....                  | 272                              |
| Towing eye.....                              | 87                               |
| Traction control (ASR).....                  | 17, 21, 121                      |
| Traffic information (TA).....                | 329, 363                         |
| Traffic information<br>(TMC).....            | 328                              |
| Trailer.....                                 | 147, 218                         |
| Triangle, warning.....                       | 238                              |
| Trip computer.....                           | 37-39                            |
| Trip distance recorder.....                  | 35                               |
| Tyres.....                                   | 10                               |
| Tyre under-inflation<br>detection.....       | 24, 209, 211, 245                |

---

## U

|                                   |              |                                       |              |
|-----------------------------------|--------------|---------------------------------------|--------------|
| Under-inflation (detection) ..... | 209          | Windscreen, heated.....               | 117          |
| Unlocking .....                   | 50, 56, 58   | Wiper blades (changing).....          | 117, 222     |
| Updating risk areas.....          | 327          | Wiper, rear.....                      | 115          |
| Updating the date.....            | 47           | Wipers .....                          | 16, 114, 116 |
| Updating the time.....            | 47           | Wipers, automatic rain sensitive..... | 114, 116     |
| USB.....                          | 85, 312, 368 |                                       |              |

---

## V

|                   |               |
|-------------------|---------------|
| Ventilation ..... | 10, 91-94, 99 |
|-------------------|---------------|

---

## W

|  |              |
|--|--------------|
| Warning and indicator lamps .....                  | 13, 17, 18   |
| Warning lamp, braking system .....                 | 21           |
| Warning lamp, Diesel engine pre-heater .....       | 15           |
| Warning lamps .....                                | 15, 18, 20   |
| Warning lamp, SCR emissions control<br>system..... | 27           |
| Warning lamp, Service.....                         | 19           |
| Warning lamp, Stop .....                           | 18           |
| Washer jets, heated .....                          | 117          |
| Weights .....                                      | 278, 285     |
| Wheel, spare .....                                 | 87, 246, 247 |
| Window controls .....                              | 70           |









**!** Labels are applied at various points on your vehicle. They carry safety warnings as well as vehicle identification information. Do not remove them: they form an integral part of your vehicle.

Reproduction or translation of all or part of this document is prohibited without written authorisation from Automobiles PEUGEOT.

Automobiles PEUGEOT declares, by application of the provisions of the European legislation (Directive 2000/53) relating to End of Life Vehicles, that it achieves the objectives set by this legislation and that recycled materials are used in the manufacture of the products that it sells.

For any work on your vehicle, use a qualified workshop that has the technical information, competence and equipment required, which a PEUGEOT dealer is able to provide.

### **We draw your attention to the following points:**

- The fitting of electrical equipment or accessories not listed by PEUGEOT may cause faults and failures with the electrical system of your vehicle. Contact a PEUGEOT dealer for information on the range of recommended accessories.
- As a safety measure, access to the diagnostic socket, used for the vehicle's electronic systems, is reserved strictly for PEUGEOT dealers or qualified workshops, equipped with the special tools required (risk of malfunctions of the vehicle's electronic systems that could cause breakdowns or serious accidents). The manufacturer cannot be held responsible if this advice is not followed.
- Any modification or adaptation not intended or authorised by Automobiles PEUGEOT or carried out without meeting the technical requirements defined by the manufacturer would lead to the suspension of the legal and contractual warranties.

Printed in the EU  
Anglais

04-16



**PEUGEOT**

AUTOMOBILES PEUGEOT - Siège Social : 75, avenue de la Grande-Armée 75016 Paris - France

Tél. : +33 (0)1 40 66 55 11 - Fax : +33 (0)1 40 66 54 14 - Téléc. : 645 700 F

<http://www.peugeot.com>

Société anonyme au capital de 172.711.770 € - R.C.S. : 552 144 503 R.C.S. Paris - SIRET : 552 144 503 00018 - APE : 2910Z





# Compatibility of fuels

## Fuel used for petrol engines

The petrol engines are compatible with bio-fuels that conform to current and future European standards and can be obtained from filling stations.

**E5** Petrol that meets the EN228 standard, mixed with a bio-fuel meeting the EN15376 standard.

**E10**

**i** The only petrol additives authorised for use are those that meet the B715001 standard.

## Fuel used for Diesel engines

The Diesel engines are compatible with biofuels that conform to current and future European standards and can be obtained from filling stations.

**B7** Diesel fuel that meets standard EN590 mixed with a biofuel that meets standard EN14214 (possibly containing up to 7% Fatty Acid Methyl Ester).

**E5**

**E10**

**B7**

**B10**

**XTL**

**B20**

**B30**

**B10** Diesel fuel that meets standard EN16734 mixed with a biofuel that meets standard EN14214 (possibly containing up to 10% Fatty Acid Methyl Ester).

**XTL** Paraffinic Diesel fuel that meets standard EN15940 mixed with a biofuel that meets standard EN14214 (possibly containing up to 7% Fatty Acid Methyl Ester).

**B20** The use of B20 or B30 fuel meeting standard EN16709 is possible in your Diesel engine. However, this use, even occasional, requires strict application of the special servicing conditions referred to as "Arduous conditions".

**B30**

For more information, contact a dealer of the brand or a qualified workshop.

**!** The use of any other type of (bio) fuel (vegetable or animal oils, pure or diluted, domestic fuel...) is strictly prohibited (risk of damage to the engine and fuel system).

**i** The only Diesel additives authorised for use are those that meet the B715000 standard.

## Diesel fuel at low temperature

In temperatures below 0°C (+32°F), the formation of paraffins in the summer diesel fuels may result in abnormal operation of the fuel supply system. To avoid this, the use of winter diesel fuels is recommended, keeping the tank topped up to more than 50% of its capacity.

If in spite of this you experience difficulties starting the engine in temperatures below -15°C (+5°F), simply leave the vehicle in a garage or a heated workshop for a while.

## **i** Travelling abroad

**Certain fuels could damage the engine of your vehicle. In certain countries, the use of a particular fuel may be required (specific octane rating, specific sales name...) to ensure correct operation of the engine.**

For any additional information, contact your dealer.



16CAR.A040